

Town of Truro Planning Board
24 Town Hall Road
Truro, MA 02666

RE: Dish NSD Project No. BOBOS00593A
SBA Project No. MA12227-A
5 Town Dump Road, Truro, MA 02666

Good afternoon:

SBA Communications will be collocating the Dish Network on our existing cell tower located at 5 Town Dump Road, Truro, MA. * Scope of work will include but not be limited to the installation of (3) new antennas & (6) Radios on (3) new sector frame mounts.

Enclosed please see:

(1) Original and (9) copies of:

- This Cover Letter
- Planning Board Application for Modification to Existing Telecommunications Structures by Special Permit Under 40.5 Procedures.
- Zoning Board of Appeals Application for Hearing
- Certified Abutters List Request Form
- Building Permit Application
- MA State Insurance Information
- Eligible Facilities Request (EFR)
- Structural Analysis
- Appurtenance Mount Analysis Report
- Construction Drawings
- Electromagnetic Emissions Report

Please let this letter additionally serve as formal request for a waiver for compliance with §40.5.B.(19) of the Truro Zoning Bylaws, as this is a new colocation on an existing in service telecom tower.

Thank you,

Catherine Ware
Site Development Specialist
SBA Communications
134 Flanders Road
Westborough, MA 01581
(917)868-8365
CWare@sbsite.com

* This application is eligible for relief under the parameters of the Eligible Facilities Request (“EFR”) ; Section 6409 of the Spectrum Act (Pub. Law No. 112-96, 126 Stat 156) (codified at 47 U.S.C. § 1455), as well as the FCC’s subsequent Report and Order of October 17, 2014, and Declaratory Ruling of June 9, 2020. Therefore, the proposed upgrades are not subject to discretionary review and are admissible per Federal Law.



Town of Truro Planning Board

P.O. Box 2030, Truro, MA 02666

APPLICATION FOR MODIFICATIONS TO EXISTING TELECOMMUNICATION STRUCTURES BY SPECIAL PERMIT UNDER §40.5 PROCEDURES

To the Town Clerk and the Planning Board of the Town of Truro, MA

Date 8/25/2023

The undersigned hereby files an application with the Truro Planning Board for a Special Permit to modify an existing telecommunication structure pursuant to §40.5 of the Truro Zoning Bylaw:

1. General Information

Proposed project (*describe*): Dish Wireless collocation at existing SBA cell site: Install (3) antennas and associated equipment per attached plans. No change to tower/height or compound/size. Application is an Eligible Facilities Request under Section 6409 of the Middle Class Tax Relief Act and reserves its rights thereunder.

Property Address 5 Town Du mp Road Map(s) and Parcel(s) 55/22-A

Registry of Deeds title reference: Book _____, Page _____, or Certificate of Title Number _____ and Land Ct. Lot # _____ and Plan # _____

Applicant's Name Catherine Ware / SBA Communications

Applicant's Legal Mailing Address 134 Flanders Road, Westborough, Ma 01581 Suite 125

Applicant's Phone(s), Fax and Email Cware@sbsite.com 917-868-8365

Applicant is one of the following: (*please check appropriate box*)

*Written Permission of the owner is required for submittal of this application.

Owner Prospective Buyer* Other*

Owner's Name and Address SBA Towers II LLC

Owner's Phone(s), Fax and Email Cware@sbsite.com 917-868-8365

Representative's Name and Address Catherine Ware 134 Flanders Rd, Westborough Ma 01581

Representative's Phone(s), Fax and Email _____

2. **Waiver(s) Request** – The Planning Board may, upon the request of the applicant, waive submission requirements of §40.5.B.19.

3. The completed application **shall also** be submitted **electronically** to the Planning Department Assistant at esturdv@truro-ma.gov in its entirety (including all plans and attachments).

- The applicant is **advised** to consult with the Building Commissioner and/or Planning Department prior to submitting this application.

Signature(s)

Catherine Ware - SBA Communications

Applicant(s)/Representative *Printed Name(s)*

Catherine Ware

Applicant(s)/Representative *Signature(s)*

John Morrison - SBA Towers II LLC

Owner(s) *Printed Name(s)* or written permission

John Morrison

Owner(s) *Signature(s)* or written permission

Your signature on this application authorizes the Members of the Planning Board and town staff to visit and enter upon the subject property.



TOWN OF TRURO

Assessors Office

Certified Abutters List

Request Form

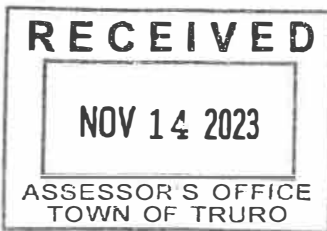

DATE: 10-23-23

NAME OF APPLICANT: DISH WIRELESS
 NAME OF AGENT (if any): CATHERINE WARE - SBA Communications
 MAILING ADDRESS: 134 Flanders Rd Suite 125 Westborough MA 01581
 CONTACT: HOME/CELL 917 868 8365 EMAIL _____
 PROPERTY LOCATION: 5 Town Dump Rd, Truro, MA 02666
(street address)
 PROPERTY IDENTIFICATION NUMBER: MAP 55 PARCEL 2 EXT. A
(if condominium)

ABUTTERS LIST NEEDED FOR:

(please check all applicable)

FEE: \$15.00 per checked item

(Fee must accompany the application unless other arrangements are made)

- | | | |
|---|---|---|
| <input type="checkbox"/> Board of Health ⁵ | <input checked="" type="checkbox"/> Planning Board (PB) | <input checked="" type="checkbox"/> Zoning Board of Appeals (ZBA) |
| <input type="checkbox"/> Cape Cod Commission | <input checked="" type="checkbox"/> Special Permit ¹ | <input checked="" type="checkbox"/> Special Permit ¹ |
| <input type="checkbox"/> Conservation Commission ⁴ | <input type="checkbox"/> Site Plan ² | <input type="checkbox"/> Variance ¹ |
| <input type="checkbox"/> Licensing | <input type="checkbox"/> Preliminary Subdivision ³ | |
| Type: _____ | <input type="checkbox"/> Definitive Subdivision ³ | |
| <input type="checkbox"/> Other _____ | <input type="checkbox"/> Accessory Dwelling Unit (ADU) ² | |

(Fee: Inquire with Assessors)

(Please Specify)

Note: Per M.G.L., processing may take up to 10 calendar days. Please plan accordingly.

THIS SECTION FOR ASSESSORS OFFICE USE ONLY

Date request received by Assessors: Nov 14, 2023 Date completed: 11/15/23
 List completed by: Laura Geiges Date paid: 11/14/23 Cash/Check 2179510

¹Abutters, owners of land directly opposite on any public or private street or way, and abutters to the abutters within 300 feet of the property line.

²Abutters to the subject property, abutters to the abutters, and owners of properties across the street from the subject property.

³Landowners immediately bordering the proposed subdivision, landowners immediately bordering the immediate abutters, and landowners located across the streets and ways bordering the proposed subdivision. **Note:** For Definitive Subdivision only, responsibility of applicant to notify abutters and produce evidence as required.

⁴All abutters within 300 feet of parcel, except Beach Point between Knowles Heights Road and Provincetown border, in which case it is all abutters within 100 feet. **Note:** Responsibility of applicant to notify abutters and produce evidence as required.

⁵Abutters sharing any boundary or corner in any direction – including land across a street, river or stream. **Note:** Responsibility of applicant to notify abutters and produce evidence as required.



TRURO ASSESSORS OFFICE

PO Box 2012 Truro, MA 02666

Telephone: (508) 214-0921

Fax: (508) 349-5506

Date: November 15, 2023

To: Catherine Ware, SBA Communications

From: Assessors Department

Certified Abutters List: 5 Town Dump Road (Map 55 Parcel 2 Ext A)

Planning Board – Special Permit

Attached is a combined list of abutters for 5 Town Dump Road (Map 55 Parcel 2 Ext A).

The current owners are SBA Towers II LLC.

The names and addresses of the abutters are as of November 10, 2023 according to the most recent documents received from the Barnstable County Registry of Deeds.

Certified by: 

Laura Geiges
Assistant Assessor / Data Collector

5 Town Dump Road
 Map 55 Parcel 2 Ext A
 Planning Board - Special Permit

TOWN OF TRURO, MA
 BOARD OF ASSESSORS
 P.O. BOX 2012, TRURO MA 02666

Abutters List Within 300 feet of Parcel 55/2/A

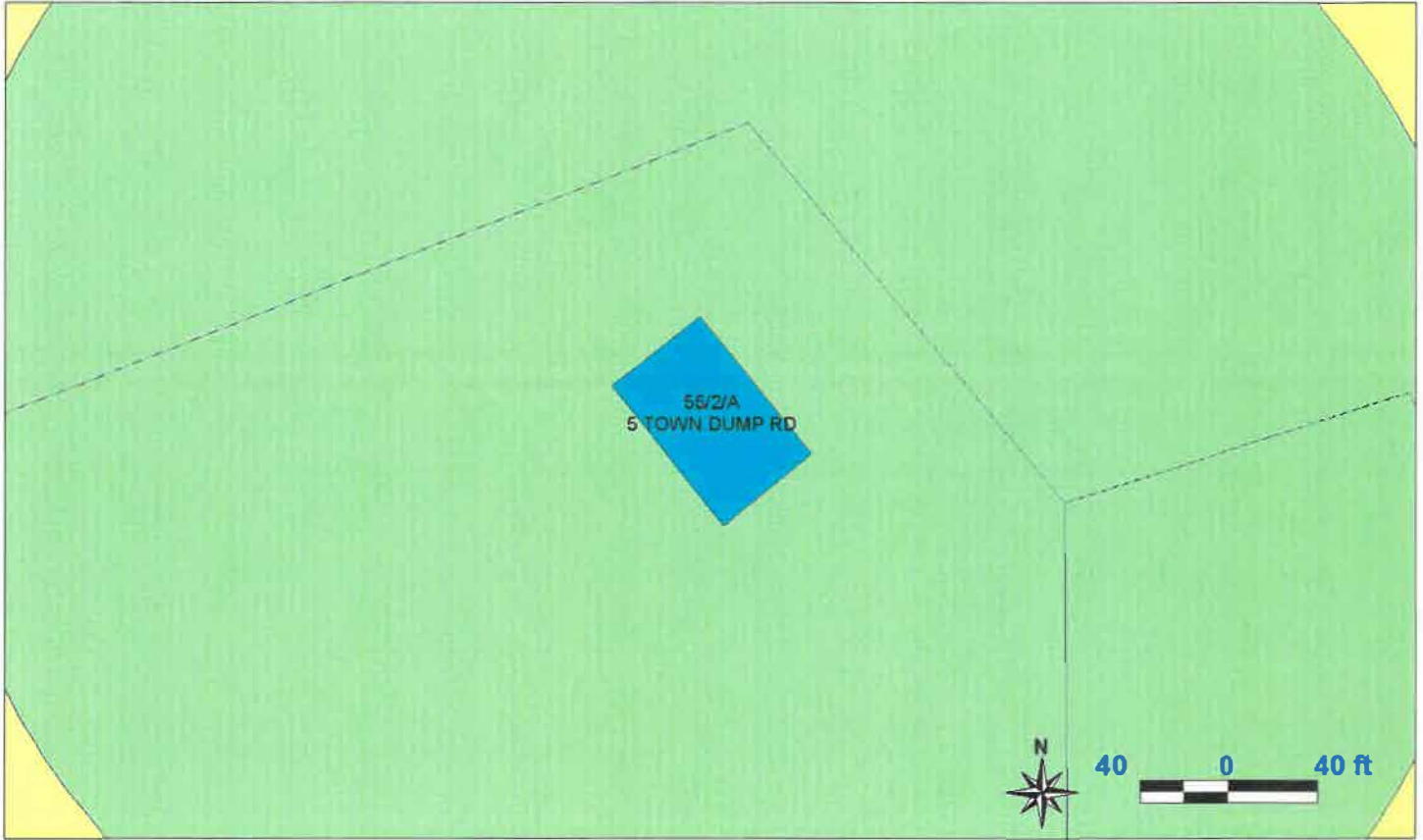

Key	Parcel ID	Owner	Location	Mailing Street	Mailing City	ST	ZipCd/Country
7292	40-999-0-E	USADEPT OF INTERIOR Cape Cod National Seashore	0 CAPE COD NATIONAL SEASHORE	99 Marconi Site Rd	Wellfleet	MA	02667
3341	55-2-0-E	TOWN OF TRURO	5 TOWN DUMP RD	PO BOX 2030	TRURO	MA	02666-2030
5944	55-2-A-R	S B A TOWERS II LLC	5 TOWN DUMP RD	TAX DEPT MA12227-A 8051 CONGRESS AVE	BOCA RATON	FL	33487
3342	55-3-0-E	TOWN OF TRURO	5-A TOWN DUMP RD	PO BOX 2030	TRURO	MA	02666-2030

LG 11/15/23

40-999-0-E

USA-DEPT OF INTERIOR
Cape Cod National Seashore
99 Marconi Site Rd
Wellfleet, MA 02667

55-2-0-E

TOWN OF TRURO
PO BOX 2030
TRURO, MA 02666-2030

55-2-A-R

S B A TOWERS II LLC
TAX DEPT MA12227-A
8051 CONGRESS AVE
BOCA RATON, FL 33487

55-3-0-E

TOWN OF TRURO
PO BOX 2030
TRURO, MA 02666-2030

LG 11/15/23

Building Permit Application

Massachusetts State Building Code, 780 CMR, 9th Edition



TOWN OF TRURO

Building Department

24 Town Hall Rd.

PO Box 2030

Truro, MA 02666

Tel (508) 349-7004 x131 Fax (508) 349-5508

Permit #: _____ Fee: \$50 Application Fee
Fee: _____

SITE INFORMATION

Project Site: **5 Town Dump Road, Truro MA 02666**

Assessors Map & Parcel: **55-2-A**

Zoning District: **SFO**

Outside Flood Zone

Inside Flood Zone – Specify: _____

Setbacks:

Front:

Left Side:

Right Side:

Rear:

Lot Area (sq. ft.)

Frontage:

Water Supply: Private Public

Subject to Policy 28: Curb Cut? Y N

If Yes, please attach a copy of the approval to this application.

SUBJECT TO NHESP/MESA REVIEW? Y N

* IF YES, PLEASE ATTACH A COPY OF THE APPROVAL.

PROPERTY OWNERSHIP

Owner of Record: **Town of Truro, MA**

Mailing Address: **P.O. Box 2030 Truro, MA 02666 - Attn: Landlord**

Phone: **(917)868-8365**

E-mail: **cware@sbsite.com**

Property Owner Authorization

Signature: _____

Date: _____

PROJECT INFORMATION

1 & 2 Family Home

Commercial / Other than
1 & 2 Family Home*

Change of
Use

DEMO - Subject to Chapter VI:
Historic Properties Bylaw? Y N

*** BUILDINGS IN EXCESS OF 35,000 CU. FT. MUST MEET CONTROL CONSTRUCTION REGULATIONS (780 CMR 116).
ADDENDUM TO PERMIT APPLICATION AVAILABLE IN BUILDING DEPARTMENT.**

New Dwelling: # of units _____

Commercial Building

Addition

Alteration

Mechanical

Accessory Structure: (type) Cellular tower

Other: _____

Detailed Description of Proposed Work: DISH Wireless - Adding 3 antennas and 6 RRU's and 1 OVP
to the existing telecommunications facility located at 5 Town Dump Road in Truro.

Construction drawings and Structural Analysis attached

****We are filing this application with an eligible facilities request to modify an existing support structure**
pursuant to Section 6409(a) of the Middle-Class Tax Relief and Job Creation Act of 2012

(" Spectrum Act ") and the rules of the Federal Communications

(" FCC "). See Pub. Law No. 112-96, 126 Stat. 156 (2012); 47 C.F.R. §1.6100.

Estimated Construction Cost: 40,000		Debris Disposal: (Landfill or Company Name)	
Floor Area: (Proposed Work Only)		Basement: <input type="checkbox"/> unfinished <u>N/A</u> <input type="checkbox"/> finished <u>N/A</u>	
1 st flr: <u>N/A</u>	2 nd flr: <u>N/A</u>	Porch/Deck: <u>N/A</u>	Other:
#fireplaces:	#chimneys:	#bathrooms: existing _____ proposed _____	
#bedrooms: existing _____ proposed _____			
Type of Heating System: <u>N/A</u>		Type of Cooling System: <u>N/A</u>	
CONTRACTOR INFORMATION*			
*HOMEOWNER'S AFFIDAVIT REQUIRED IF OWNERS ARE DOING THEIR OWN WORK (RESIDENTIAL PROJECTS ONLY)			
Contractor Name: Timberline Construction Company			
Address: 300 Pine Street, Canton, MA 02021			
Phone: (339)502-5000		Email: borlandi@timberlinecommunications	
CSL#:		HIC #	
OFFICE USE			
HEALTH/ CONSERVATION AGENT Review _____			

Signature:		Date:	
Other Comments: _____			

BUILDING COMMISSIONER Review & Approval: _____			

Signature:		Issuance Date:	

BUILDING PERMIT APPLICATION DOCUMENT CHECKLIST

This checklist is part of the permit application and must be completed. If not completed the application may be considered incomplete and cause the permit to be denied.

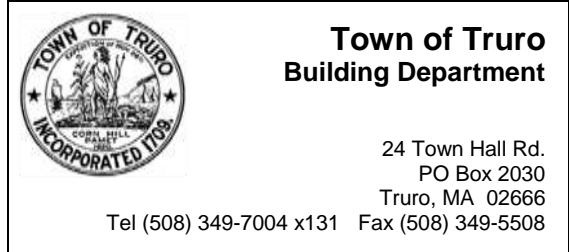

Please note that marked-up archival drawings do not constitute acceptable documents for permitting purposes.

One and/or Two Family Home

Completed application form

1 copy original site plan showing building setbacks and grades.

2 (min.) copies building plans – One can be full size if greater than 11 x 17. One must be no greater than 11 x 17 for department filing. Electronic version is acceptable, in addition.

Drawings indicating all relevant information including but not limited to:

- Fully dimensioned foundation, floor and structural plans;
- Building elevations showing finish materials and critical dimensions;
- Building/wall sections describing building construction, energy related details and showing critical vertical dimensions.
- Smoke, CO and heat detectors must be shown.
- Door and window information demonstrating conformance with minimum room and dwelling egress and emergency escape.
- Exterior window and door information demonstrating conformance with light, ventilation and energy requirements.
- Location and design of any required fire separation assemblies.

All structural conditions noted on plans – braced wall lines indicated and analysis shown and/or engineered solution with registered design professional's certification and/or other prescriptive solution allowed by Code.

1 copy Energy Code compliance documents (check only one below)

- HERS/performance rating document – new construction
- ResCheck (2015 MA) – additions/alterations- per 2015 IECC R502 & 503
- Prescriptive – values shown on plans – see 2015 IECC table R402.1.2 and other req's.

Photocopy of CSL and HIC (if applicable) shown on application form

Worker's Compensation Insurance Affidavit and copy of current certificate of insurance

Homeowner's License Exemption (if qualified and there is no CSL)

Copy of recorded approvals from local regulatory boards

If street access is required and property is on a Town road, copy of Curb Cut approval from the Board of Selectmen

For applications for Modular and other than 1&2 Family Structures see Checklist on next page.

Modular Home (Homeowner license exemption not allowed)

- 2 copies of foundation plan
- Approved plans by MA Board of Building Regulations & Standards with evidence of 3rd party inspection
- Manufacturer's certification of installer/set crew.

Structures Other than 1 & 2 Family Home

- Completed Application form
- Stamp and signature of registered design professional

2 (min.) copies building plans – One can be full size if greater than 11 x 17. One must be no greater than 11 x 17 for filing. Electronic version is acceptable, in addition. Drawings must indicate all relevant information including but not limited to: Fully dimensioned foundation, floor and structural plans; fire separation assemblies; door, window and room finish schedules; building elevations with critical dimensions; building/wall sections describing building construction and energy related details and showing critical vertical dimensions.

COMcheck Envelope, Lighting and Mechanical Compliance Certificates and Plan Review Inspection Checklist for the purposes of demonstrating compliance with the energy code.

Construction Control Document(s)

Tier 1 Fire Protection System document per section 902.2.1

Code analysis indicating (but not limited to) all use groups, construction types, allowable areas, fire separations, egress paths and distances. This analysis can be part of drawing set.

Contractor credentials

Worker's Compensation Insurance Affidavit and copy of current certificate of insurance

Recorded copy of any local regulatory board approvals

If modular construction see items above

Notes:



CERTIFICATE OF LIABILITY INSURANCE

DATE (MM/DD/YYYY) 4/10/2023

THIS CERTIFICATE IS ISSUED AS A MATTER OF INFORMATION ONLY AND CONFERS NO RIGHTS UPON THE CERTIFICATE HOLDER. THIS CERTIFICATE DOES NOT AFFIRMATIVELY OR NEGATIVELY AMEND, EXTEND OR ALTER THE COVERAGE AFFORDED BY THE POLICIES BELOW.

IMPORTANT: If the certificate holder is an ADDITIONAL INSURED, the policy(ies) must have ADDITIONAL INSURED provisions or be endorsed. If SUBROGATION IS WAIVED, subject to the terms and conditions of the policy, certain policies may require an endorsement.

Table with 2 main columns: PRODUCER (Henderson Brothers Inc) and CONTACT NAME/PHONE/FAX/E-MAIL ADDRESS. Includes a sub-table for INSURER(S) AFFORDING COVERAGE with columns for INSURER A-F and NAIC #.

COVERAGES CERTIFICATE NUMBER: REVISION NUMBER:

THIS IS TO CERTIFY THAT THE POLICIES OF INSURANCE LISTED BELOW HAVE BEEN ISSUED TO THE INSURED NAMED ABOVE FOR THE POLICY PERIOD INDICATED. NOTWITHSTANDING ANY REQUIREMENT, TERM OR CONDITION OF ANY CONTRACT OR OTHER DOCUMENT WITH RESPECT TO WHICH THIS CERTIFICATE MAY BE ISSUED OR MAY PERTAIN, THE INSURANCE AFFORDED BY THE POLICIES DESCRIBED HEREIN IS SUBJECT TO ALL THE TERMS, EXCLUSIONS AND CONDITIONS OF SUCH POLICIES.

Main table with columns: INSR LTR, TYPE OF INSURANCE, ADDL INSD, SUBR WVD, POLICY NUMBER, POLICY EFF (MM/DD/YYYY), POLICY EXP (MM/DD/YYYY), LIMITS. Rows include Commercial General Liability, Automobile Liability, Umbrella Liability, and Workers Compensation.

DESCRIPTION OF OPERATIONS / LOCATIONS / VEHICLES (ACORD 101, Additional Remarks Schedule, may be attached if more space is required) For Informational Purpose Only

CERTIFICATE HOLDER CANCELLATION

Table with 2 columns: CERTIFICATE HOLDER (Evidence of Coverage) and CANCELLATION (Should any of the above described policies be cancelled before the expiration date thereof, notice will be delivered in accordance with the policy provisions. Includes signature area).



ADDITIONAL REMARKS SCHEDULE

AGENCY Henderson Brothers Inc		NAMED INSURED SBA Communications Corporation 8051 Congress Ave. Boca Raton, FL 33487	
POLICY NUMBER SEE PAGE 1			
CARRIER SEE PAGE 1	NAIC CODE SEE P 1	EFFECTIVE DATE: SEE PAGE 1	

ADDITIONAL REMARKS

THIS ADDITIONAL REMARKS FORM IS A SCHEDULE TO ACORD FORM,
FORM NUMBER: ACORD 25 FORM TITLE: Certificate of Liability Insurance

Named Insureds Continued

SBA GC Holdings, LLC Limited	SBA Towers South Africa Proprietary, Limited F/K/A Atlas Tower Proprietary, Limited	
SBA Edge (JAX), LLC Towers SRL	SBA GC Parent I, LLC	SBA Torres Argentina SRL f/k/a Southern
SBA UK Holdings Limited	SBA GC Parent II, LLC	T.A. Investment Holdings Inc.
SBA GC Towers, LLC	SBA Towers USVI, Inc.	Torres Andinas Holdco, Inc.
SBA Guarantor LLC	SBA Towers X, LLC	Tower Funding, LLC
Brazil Shareholder I, LLC	SBA Holdings LLC	Tower Funding II, LLC
Brazil Shareholder II, LLC	SBA Holdings e Participações Ltda.	TV6 Holdings LLC
Central America Equityholder, LLC	SBA HQ, LLC	Tower Funding III, L.P.
Chile Shareholder, LLC	SBA Infrastructure, LLC	Tower Funding GP, Inc.
Colombia Shareholder, LLC	SBA Inmuebles Peru, S.A.C. fka MAA	Golden State Licensing, LLC.
Costa Rica Quotaholder, LLC	SBA Land, LLC fka TCO Land LLC	SBA Towers VII, LLC
SBA Monarch Steel, LLC	Desarrollos Inmobiliarios Inmo Aplicanet SA	
Desarrollos Inmobiliarios Inmoavilies S.A.	SBA Monarch Towers I, LLC	DC Matrix Internet Ltda
Ecuador Shareholder, LLC	SBA Monarch Towers III, LLC	DC Matrix Telecomuncacoes Ltda
Ecuador Shareholder II, LLC	SBA Negocios Inmobiliarios Ltda	Minara Tanzania Limited
SBA Network Management, Inc.	SBA Connect, LLC	Minara Zanzibar Limited
El Salvador Shareholder I, LLC	SBA New Builds, LLC	RTGF Holdings Limited
El Salvador Shareholder II, LLC	SBA Properties, LLC	RTGF Midco Limited
Guatemala Shareholder I, LLC	SBA Puerto Rico, LLC	SBA Edge, LLC
Guatemala Shareholder II, LLC	SBA RSA Holdings, LLC	SBA Towers Philippines, Inc
SBA Senior Finance II LLC	SBA TRS Holdco, LLC	SBA Towers Philippines Holdings, Inc.
SBA Senior Finance, LLC	SBA Ventures, LLC	SBA Towers VI, LLC
SBA Site Management, LLC	SBA Network Services, LLC	SBA Towers XI, LLC
Memphis Towers, LLC	SBA Sites, LLC	SBA South Africa Equityholder, LLC
SBA Steel LLC	SBA Worth Telecom LLC	fka Atlas Tower South Africa Equityholder, LLC
SBA Steel II, LLC	Torreaviles S.A	
Nicaragua Shareholder I, LLC	SBA Structures, LLC	
Nicaragua Shareholder III, LLC	SBA Telecommunications, LLC.	
OFO LLC	SBA Telecomunicaciones Colombia S.A.S. f/k/a/ Torres Andinas S.A.S.	
Panama Shareholder, LLC	SBA Towers, LLC	
Peru Shareholder I, LLC	SBA Torres Brasil, Limitada	
Peru Shareholder II, LLC	SBA Torres Chile, Spa	
Quality Tower Developers, LLC	SBA Torres Colombia S.A.S	
SBA Torres Costa Rica, Limitada	SBA Towers VIII, LLC	
SBA 2012 TC Assets, LLC	SBA Torres Ecuador SBAEC, S.A.	
SBA 2012 TC Assets Land, LLC	SBA Torres El Salvador, S.A. De C.V.	
SBA 2012 TC Assets PR, LLC	SBA Torres Guatemala, Limitada	
SBA 2012 TC Holdings, LLC	SBA Torres Nicaragua, S.A.	
SBA 2012 TC Land II, LLC	SBA Torres Nicaragua II, LLC	
SBA 2014 PR, Inc. f/k/a Soluwise, Inc.	SBA Torres Panama, S.A.	
SBA 2016 TC USVI, LLC f/k/a TowerCo 2013 USVI LLC	SBA Torres Peru, S.A. fka Torres Andinas, S.A.	
SBA BTS, LLC	SBA Towers II LLC	
SBA Canada Holdings, Inc.	SBA Towers III LLC	
SBA Canada, ULC (fka Jade Tower ULC)	SBA Towers IV, LLC	
SBA Canada II, ULC	SBA Towers IX, LLC	
SBA DAS & Small Cells, LLC	SBA Towers V, LLC	
SBA Depositor LLC	Desarrollos Inmobiliarios Ecuador SBAINMO-EC S.A.	

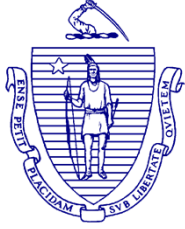

The Commonwealth of Massachusetts
 Department of Industrial Accidents
 1 Congress Street, Suite 100
 Boston, MA 02114-2017
 www.mass.gov/dia

Workers' Compensation Insurance Affidavit: General Businesses.
 TO BE FILED WITH THE PERMITTING AUTHORITY.

Applicant Information

Please Print Legibly

Business/Organization Name: _____

Address: _____

City/State/Zip: _____ Phone #: _____

Are you an employer? Check the appropriate box:

- 1. I am a employer with _____ employees (full and/or part-time).*
- 2. I am a sole proprietor or partnership and have no employees working for me in any capacity. [No workers' comp. insurance required]
- 3. We are a corporation and its officers have exercised their right of exemption per c. 152, §1(4), and we have no employees. [No workers' comp. insurance required]**
- 4. We are a non-profit organization, staffed by volunteers, with no employees. [No workers' comp. insurance req.]

Business Type (required):

- 5. Retail
- 6. Restaurant/Bar/Eating Establishment
- 7. Office and/or Sales (incl. real estate, auto, etc.)
- 8. Non-profit
- 9. Entertainment
- 10. Manufacturing
- 11. Health Care
- 12. Other _____

*Any applicant that checks box #1 must also fill out the section below showing their workers' compensation policy information.

**If the corporate officers have exempted themselves, but the corporation has other employees, a workers' compensation policy is required and such an organization should check box #1.

I am an employer that is providing workers' compensation insurance for my employees. Below is the policy information.

Insurance Company Name: _____

Insurer's Address: _____

City/State/Zip: _____

Policy # or Self-ins. Lic. # _____ Expiration Date: _____

Attach a copy of the workers' compensation policy declaration page (showing the policy number and expiration date).

Failure to secure coverage as required under Section 25A of MGL c. 152 can lead to the imposition of criminal penalties of a fine up to \$1,500.00 and/or one-year imprisonment, as well as civil penalties in the form of a STOP WORK ORDER and a fine of up to \$250.00 a day against the violator. Be advised that a copy of this statement may be forwarded to the Office of Investigations of the DIA for insurance coverage verification.

I do hereby certify, under the pains and penalties of perjury that the information provided above is true and correct.

Signature: _____ Date: _____

Phone #: _____

Official use only. Do not write in this area, to be completed by city or town official.

City or Town: _____ Permit/License # _____

Issuing Authority (circle one):

- 1. Board of Health
- 2. Building Department
- 3. City/Town Clerk
- 4. Licensing Board
- 5. Selectmen's Office
- 6. Other _____

Contact Person: _____ Phone #: _____

ELIGIBLE FACILITIES REQUEST (EFR) APPLICATION FORM

Orig. Date of Submittal: 9/19/23

Submitted by:

Name: Catherine Ware

Title: Site Development Specialist on behalf of SBA Network Services and DISH Wireless

Contact Information: cware@sbsite.com
(917)868-8365

Name of Jurisdiction: Town of Truro

Address of Jurisdiction: 24 Town Hall Road

Contact Name for Jurisdiction: Elizabeth Sturdy

Name of Local Government Permit Application: Planning Application for Special Permit

Local Government File #: [Click here to enter text.](#)

Street Address of Site: 5 Town Dump Rd

Tax Parcel # of Site: 55-2-A

Latitude/Longitude of Site: 41.98578; -70.04133

List Each Piece of Transmission Equipment that will be Collocated or Added:

(3) JMA Wireless Antenas, (6) RRU/RRH Fujitsu, (1) Raycap OVP

List Each Piece of Transmission Equipment that will be Removed:

N/A

List Cabinets that will be Collocated or Added at the Site:

None

List Cabinets that will be Removed at the Site:

None

Permit Application Amount: \$350

Municipal Consultant Review Fee Deposit: [Click here to enter text.](#)

ELIGIBLE FACILITIES REQUEST (EFR) CERTIFICATION OF NON-SUBSTANTIAL
CHANGES TO A WIRELESS TOWER NOT LOCATED WITHIN A PUBLIC RIGHT OF WAY

- 1) Address of the Wireless Tower: 5 Town Dump Road, Truro MA. 02666
- 2) The height (measured in feet above ground level) of the existing Tower as originally approved, including any modifications approved prior to February 22, 2012: 190
- 3) What is the height (measured in feet above ground level) at which the modifications to the Transmission Equipment will occur on the Tower? 155'
- 4) What will be the height (measured in feet above ground level) of the existing Tower after the modifications to the Transmission Equipment are installed? 190'
- 5) Effect of modifications of Transmission Equipment on Tower height:
 - a. Will the modifications in Transmission Equipment (addition, removal or replacement of Transmission Equipment) result in increasing the height above ground level of the existing Tower?
 Yes No
 - b. Will the modifications in Transmission Equipment result in increasing the height above ground level of the existing Tower by more than: (i) 10% of the height of the existing Tower, as originally approved, including any modifications approved prior to February 22, 2012; or (ii) twenty feet above the height of the existing Tower, as originally approved, including any modifications approved prior to February 22, 2012, whichever height increase is greater?
 Yes No
- 6) Will the modifications in Transmission Equipment (measured at the height above ground level where the Transmission Equipment will be attached to the tower) result in any Transmission Equipment protruding horizontally from the edge of tower by more than twenty (20) feet or by more than the existing width of the tower at that height, whichever of these dimensions is greater?
 Yes No
- 7) Will the proposed changes in Transmission Equipment involve excavation or placement of new equipment outside the existing Tower site or outside any access or utility easements currently related to the site?
 Yes No

8) Will the proposed modification in Transmission Equipment involve installation of more than the standard number of new equipment cabinets for the technology involved, but not to exceed four?

Yes No

9) Will the proposed modification in Transmission Equipment defeat the existing concealment elements of the Tower?

Yes No

10) Prior Conditions of Approval

a. Will the proposed modification in Transmission Equipment comply with conditions of approval imposed on the Tower prior to February 22, 2012?

Yes No

b. If the answer to 10(a) is "No," is the non-compliance due solely to any of the conditions addressed in questions 5-9 above?

Yes No

If the answer to either question 5(a) or 5(b) is "No," and the answers to questions 6-9 are "No," and the answer to either 10(a) or 10(b) is "Yes," then the proposed modifications do not substantially change the physical dimensions of the existing Tower. [Click here to enter text.](#)

This certification is dated this 9/19/ 2023

Signature *Catherine Ware*

Catherine Ware / Site Development Specialist on behalf of SBA Network Services LLC and DISH Wireless

Name & Title

Eligible Facilities Request to Modify Transmission Equipment at an Existing Communications Tower

Location: 5 Town Dump Rd, Truro Ma
DISH Site No: BOBOS00593A
SBA Communications: Agent for SBA Network Services LLC and DISH Wireless

DISH Wireless is Filing an Eligible Facilities Request

SBA Properties, LLC, on behalf of DISH Wireless and SBA Network Services, LLC as General Contractor, is submitting an Eligible Facilities Request to add (collocate) Transmission Equipment on an existing SBA Telecommunications Tower located at 5 Town Dump Rd.

The existing Tower is a structure that is 190' high and presently contains wireless facilities. The existing Tower meets the Federal Communications Commission ("FCC") definition of a Tower and DISH Wireless is an FCC licensed wireless carrier.

The list of equipment identified in this Eligible Facilities Request application is Transmission Equipment as determined by the FCC, and as defined as follows: "any equipment that facilitates transmission for any Commission-licensed or authorized wireless communication service, including, but not limited to, radio transceivers, antennas and other relevant equipment associated with and necessary to their operation, including coaxial or fiber-optic cable, and regular and back-up power supply. This definition includes equipment used in any technological configuration associated with any Commission-authorized wireless transmission, licensed or unlicensed, terrestrial or satellite, including commercial mobile, private mobile, broadcast and public safety services, as well as fixed wireless services such as microwave backhaul or fixed broadband."

Administrative Review and Approval

While local jurisdictions retain discretionary zoning review over the construction of new towers, **collocations and/or equipment upgrades such as reflected in this application must now be approved administratively.** The new law provides, in part, that:

"a State or local government may not deny, and **shall approve**, any eligible facilities request for a modification of an existing wireless tower or base station that does not substantially change the physical dimensions of such tower or base station." (Emphasis added.)

The FCC, in a Report and Order adopted on October 17, 2014, determined that **any modification to an existing telecommunications Tower that meets the following six criteria does not substantially change the physical dimensions of the existing Tower and therefore is an Eligible Facilities Request which must be granted:**

1. The modifications to the Transmission Equipment do not increase the height of the Tower by twenty feet or ten percent, whichever is greater;

2. The modifications to the Transmission Equipment do not protrude from the edge of the Tower by twenty feet or more than the width of the Tower (whichever of these two dimensions is greater) at the level where the transmission equipment modifications are made;
3. The modifications to the Transmission Equipment do not involve the installation of more than the standard number of equipment cabinets for the technology involved, not to exceed four;
4. The modifications to the Transmission Equipment do not entail any excavation or deployment outside of the Tower site;
5. The modifications to the Transmission Equipment do not defeat any existing concealment elements of the Tower;
6. The modifications to the Transmission Equipment comply with prior conditions of approval of the Tower, unless the non-compliance is due to an increase in height, increase in width, addition of equipment cabinets, or new excavation that does not exceed the corresponding “substantial change” thresholds in numbers 1-4.

We are providing certification that each of the six review criteria identified by the FCC will be met, and that the proposed collocation fully conforms to Section 6409(a) as enacted by Congress and as interpreted by the FCC.

Expedited Permit Processing and Deemed Granted Designation

Under federal law, an Eligible Facilities Request is deemed granted sixty (60) days after a complete application is filed with a local jurisdiction. Accordingly, this Eligible Facilities Request must be approved within 60 days, as required by federal law and FCC regulations. If sixty days pass after the submission of DISH’s application and the Truro Planning Board has not acted to grant or deny the request, it will be deemed granted.



Tower Engineering Solutions

Phone (972) 483-0607, Fax (972) 975-9615
1320 Greenway Drive, Suite 600, Irving, Texas 75038

Structural Analysis Report

Existing 190 ft Cellxion Self Supporting Tower

Customer Name: SBA Communications Corp

Customer Site Number: MA12227-A

Customer Site Name: Truro

Carrier Name: Dish Wireless (App#: 163468, V1)

Carrier Site ID / Name: BOBOS00593A / 0

Site Location: 5 Town Dump Road

Truro, Massachusetts

Barnstable County

Latitude: 41.985783

Longitude: -70.041333

Exp.06/30/2024



10/26/2023

Analysis Result:

Max Structural Usage: 104.8% [Pass]

Max Foundation Usage: 68.0% [Pass]

Additional Usage Caused by New Mount/Mount Modification: N/A

Report Prepared By: Sital Shrestha



Tower Engineering Solutions

Phone (972) 483-0607, Fax (972) 975-9615
1320 Greenway Drive, Suite 600, Irving, Texas 75038

Structural Analysis Report

Existing 190 ft Cellxion Self Supporting Tower

Customer Name: SBA Communications Corp

Customer Site Number: MA12227-A

Customer Site Name: Truro

Carrier Name: Dish Wireless (App#: 163468, V1)

Carrier Site ID / Name: BOBOS00593A / 0

Site Location: 5 Town Dump Road

Truro, Massachusetts

Barnstable County

Latitude: 41.985783

Longitude: -70.041333

Analysis Result:

Max Structural Usage: 104.8% [Pass]

Max Foundation Usage: 68.0% [Pass]

Additional Usage Caused by New Mount/Mount Modification: N/A

Report Prepared By: Sital Shrestha

Introduction

The purpose of this report is to summarize the analysis results on the 190 ft Cellxion Self Supporting Tower to support the proposed antennas and transmission lines in addition to those currently installed. Any modification listed under Sources of Information was assumed completed and was included in this analysis.

Sources of Information

Tower Drawings	Cellxion Drawing # TBAY01793, dated 01/13/2004
Foundation Drawing	Cellxion Drawing # TBAY01793, dated 01/13/2004
Geotechnical Report	Paul B. Aldinger & Associates Project # 03135, dated 11/19/2003

Analysis Criteria

The rigorous analysis was performed in accordance with the requirements and stipulations of the TIA-222-G-2. In accordance with this standard, the structure was analyzed using **TESTowers**, a proprietary analysis software. The program considers the structure as an elastic 3-D model with second-order effects and temperature effects incorporated in the analysis. The analysis was performed using multiple wind directions.

Wind Speed Used in the Analysis:	Ultimate Design Wind Speed $V_{ult} = 149.0$ mph (3-Sec. Gust)/ Nominal Design Wind Speed $V_{asd} = 115.0$ mph (3-Sec. Gust)
Wind Speed with Ice:	50 mph (3-Sec. Gust) with 3/4" radial ice concurrent
Operational Wind Speed:	60 mph + 0" Radial ice
Standard/Codes:	TIA-222-G-2 /2015 IBC/ Massachusetts State Building Code, Ninth Edition
Exposure Category:	B
Structure Class:	III
Topographic Category:	1
Crest Height:	0 ft
Seismic Parameters:	$S_5 = 0.164$, $S_1 = 0.057$

This structural analysis is based upon the tower being classified as a Structure Class III; however, if a different classification is required subsequent to the date hereof, the tower classification will be changed to meet such requirement and a new structural analysis will be run.

Existing Antennas, Mounts and Transmission Lines

The table below summarizes the antennas, mounts and transmission lines that were considered in the analysis as existing on the tower.

Items	Elevation (ft)	Qty.	Antenna Descriptions	Mount Type & Qty.	Transmission Lines	Owner
1	187.3	3	KMW - AM-X-CD-16-65-00T-RET - Panel	(3) Sector Frames (Site Pro USF12-XX-U) + (3) Pipe Mounts	(12) 1 5/8" [(4) 3/4" DC & (2) 7/16" Fiber (Inside (2) 3" Conduits)]	AT&T
2		3	Cci - DMP5R-BU4DA - Panel			
3		3	Css - DUO1417-8686-0 - Panel			
4		3	Kathrein - 800-10121 - Panel			
5		6	Powerwave - LGP17201 - TMA			
6		3	Ericsson - RRUS 12 B4 - RRU			
7		3	Ericsson - RRUS 4478 B14 - RRU			
8		3	Ericsson - RRUS 4449 B5/B12 - RRU			
9		2	Raycap - DC6-48-60-18-8F - OVP			
10	175.0	3	Ericsson - AIR 21 B2A/B4P - Panel	(3) VFA12-HD	(4) 1 5/8" (1) 1-1/4" Fiber (1) 1.9" Fiber (3) 7/8" Hybrid	T-Mobile
11		3	Ericsson - AIR 21 B4A/B2P - Panel			
12		3	Ericsson - 840590966 - Panel			
13		3	Ericsson KRY 112 144/1			
14		3	Ericsson 4480 B71 + B85			
13	165.0	3	Swedcom - SWCP 2X7014 - Panel	(3) Modified Sector Frames with (3) BSAMNT-SBS-1-2, (3) VZWSMART-P40-238X150, (12) VZWSMART-MSK1, (3) VZWSMART-SFK1 and (3) VZWSMART-SFK3	(1) 1 5/8" Hybrid (1) W/G Ladder	Verizon
14		6	CommScope - NHH-65B-R2B - Panel			
15		3	Samsung - MT6407-77A - Panel			
16		3	B2/B66A RRH-BR049 (RFV01U-D1A)			
17		3	B5/B13 RRH-BR04C (RFV01U-D2A)			
18	1	Raycap RVZDC-6627-PF-48 - OVP				
23	138.0	3	RFS - APXVTM14-C-I20 - Panel	(3) T-Frame	(3) 1 1/4" (1) 5/8" Fiber	Sprint Nextel
24		3	RFS - APXVSPP18 - Panel			
25		3	ALU - 2500 MHz - RRU			
26		3	ALU - 1900 MHz - RRU			
27		3	ALU - 800 MHz - RRU			
28		3	ALU - 800MHz Filter			
29		4	RFS - ACU-A20-N - RET			

Proposed Carrier’s Final Configuration of Antennas, Mounts and Transmission Lines

Information pertaining to the proposed carrier’s final configuration of antennas and transmission lines was provided by SBA Communications Corp. The proposed antennas and lines are listed below.

Items	Elevation (ft)	Qty.	Antenna Descriptions	Mount Type & Qty.	Transmission Lines	Owner
19	155.0	3	JMA Wireless MX08FRO665-21 Panel	(3) Commscope MTC3975083 (Sector frames)	(1) 1.75" Hybrid	Dish Wireless
20		3	Fujitsu TA08025-B605 RRU			
21		3	Fujitsu TA08025-B604 RRU			
22		1	Raycap RDIDC-9181-PF-48 OVP			

See the attached coax layout for the line placement considered in the analysis.

Analysis Results

The results of the structural analysis, performed for the wind and ice loading and antenna equipment as defined above, are summarized as the following:

Tower Component	Legs	Diagonals	Horizontals
Max. Usage:	70.1%	104.8%	4.8%
Pass/Fail	Pass	Pass	Pass

Foundations

	Compression (Kips)	Uplift (Kips)	Shear (Kips)
Analysis Reactions	528.2	453.0	51.1

The foundation has been investigated using the supplied documents and soils report and was found adequate. Therefore, no modification to the foundation will be required.

Operational Condition (Rigidity):

Operational characteristics of the tower are found to be within the limits prescribed by TIA-222 for the installed antennas. The maximum twist/sway at the elevation of the proposed equipment is 0.0785 degrees under the operational wind speed as specified in the Analysis Criteria.

Conclusions

Based on the analysis results, the existing structure and its foundation were found to be adequate to safely support the existing and proposed equipment and meet the minimum requirements per the TIA-222 Standard under the design basic wind speed as specified in the Analysis Criteria.

Standard Conditions

1. This analysis was performed based on the information supplied to **(TES) Tower Engineering Solutions, LLC**. Verification of the information provided was not included in the Scope of Work for **TES**. The accuracy of the analysis is dependent on the accuracy of the information provided.
2. The structural analysis was performance based upon the evidence available at the time of this report. All information provided by the client is considered to be accurate.
3. The analyses will be performed based on the codes as specified by the client or based on the best knowledge of the engineering staff of **TES**. In the absence of information to the contrary, all work will be performed in accordance with the latest relevant revision of ANSI/TIA-222. If wind speed and/or ice loads are different from the minimum values recommended by the ANSI/TIA-222 standard or other codes, **TES** should be notified in writing and the applicable minimum values provided by the client.
4. The configuration of the existing mounts, antennas, coax and other appurtenances were supplied by the customer for the current structural analysis. **TES** has not visited the tower site to verify the adequacy of the information provided. If there is any discrepancy found in the report regarding the existing conditions, **TES** should be notified immediately to evaluate the effect of the discrepancy on the analysis results.
5. The client will assume responsibility for rework associated with the differences in initially provided information, including tower and foundation information, existing and/or proposed equipment and transmission lines.
6. If a feasibility analysis was performed, final acceptance of changed conditions shall be based upon a rigorous structural analysis.

Structure: MA12227-A-SBA

Site Name: Truro	Code: TIA-222-G	10/26/2023
Type: Self Support	Base Shape: Triangle	Basic WS: 115.00
Height: 190.00 (ft)	Base Width: 22.50	Basic Ice WS: 50.00
Base Elev: 0.00 (ft)	Top Width: 5.41	Operational WS: 60.00



Page: 1

Section Properties

Sect	Leg Members	Diagonal Members	Horizontal Members
1-2	SOL 5 1/4" SOLID	SAE 4X4X0.25	
3	SOL 5" SOLID	SAE 4X4X0.25	
4	SOL 5" SOLID	SAE 3.5X3.5X0.25	
5	SOL 4 3/4" SOLID	SAE 3.5X3.5X0.25	
6	SOL 4 1/4" SOLID	SAE 3X3X0.1875	
7	SOL 4" SOLID	SAE 2.5X2.5X0.25	
8	SOL 3 3/4" SOLID	SAE 2.5X2.5X0.1875	
9	SOL 3 1/2" SOLID	SAE 2.5X2.5X0.1875	
10	SOL 3" SOLID	SAE 2X2X0.1875	SAE 2X2X0.1875

Discrete Appurtenances

Attach Elev (ft)	Force Elev (ft)	Qty	Description
190.00	190.00	1	Lightning Rod
187.30	187.30	1	(3) USF12-496-U
187.30	187.30	3	AM-X-CD-16-65-00T-RET
187.30	187.30	3	Cci - DMP5R-BU4DA
187.30	187.30	3	DUO1417-8686-0
187.30	187.30	3	800 10121
187.30	187.30	6	LGP17201
187.30	187.30	3	RRUS 12
187.30	187.30	3	RRUS 4478 B14
187.30	187.30	3	4449 B5/B12
187.30	187.30	2	DC6-48-60-18-8F
175.00	175.00	3	AIR 21 B2A/B4P
175.00	175.00	3	AIR 21 B4A/B2P
175.00	175.00	3	840590966
175.00	175.00	3	Ericsson KRY 112 144/1
175.00	175.00	3	Ericsson 4480 B71 + B85
175.00	175.00	3	VFA12-HD
165.00	165.00	3	Sector Frame
165.00	165.00	3	SWCP 2X7014
165.00	165.00	6	NHH-65B-R2B
165.00	165.00	3	MT6407-77A
165.00	165.00	3	B2/B66A RRH-BR049 (RFV01U-D1A)
165.00	165.00	3	B5/B13 RRH-BR04C (RFV01U-D2A)
165.00	165.00	1	Raycap RVZDC-6627-PF-48
165.00	165.00	1	(3) V-Braces
165.00	165.00	1	(3) Stabilizer Kit
165.00	165.00	1	Handrail Kit
155.00	155.00	3	MX08FRO665-21
155.00	155.00	1	(3) MTC3975083
155.00	155.00	3	TA08025-B605
155.00	155.00	3	TA08025-B604
155.00	155.00	1	RDIDC-9181-PF-48
138.00	138.00	3	T-Arm (Flat)
138.00	138.00	3	APXVTM14-C-I20
138.00	138.00	3	APXVSP18-C
138.00	138.00	3	1900MHz RRH
138.00	138.00	3	1900MHz RRH
138.00	138.00	3	800 MHz RRH
138.00	138.00	3	ALU 800MHz External Notch Filt
138.00	138.00	4	ACU-A20-N

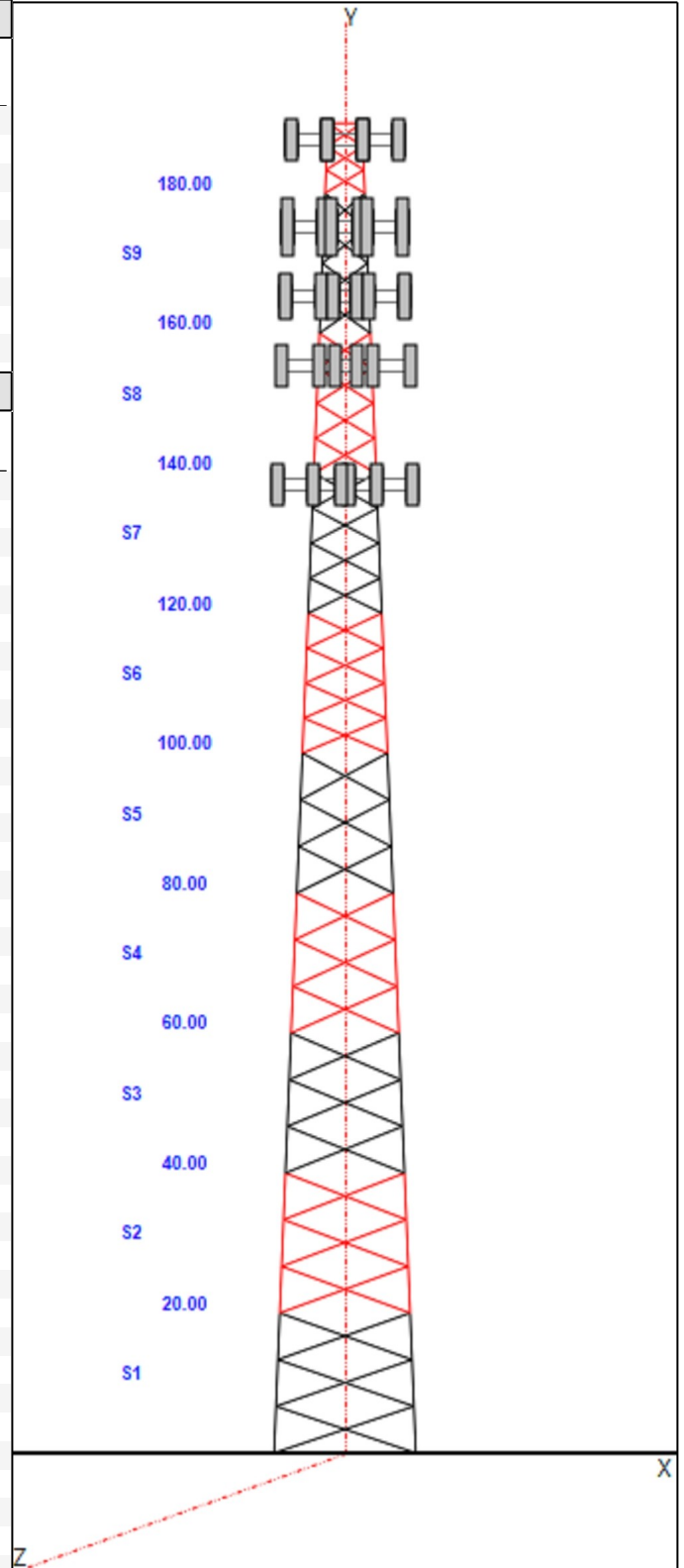

Structure: MA12227-A-SBA

Site Name: Truro	Code: TIA-222-G	10/26/2023
Type: Self Support	Base Shape: Triangle	Basic WS: 115.00
Height: 190.00 (ft)	Base Width: 22.50	Basic Ice WS: 50.00
Base Elev: 0.00 (ft)	Top Width: 5.41	Operational WS: 60.00



Linear Appurtenances

Elev From (ft)	Elev To (ft)	Qty	Description
0.00	187.30	12	1 5/8" Coax
0.00	187.30	2	3" Conduit
0.00	187.30	4	3/4" DC
0.00	187.30	2	7/16" Fiber
0.00	187.30	1	Climbing Ladder
0.00	187.30	1	Safety Cable
0.00	187.30	1	W/G Ladder
0.00	175.00	4	1 5/8" Coax
0.00	175.00	1	1-1/4" Fiber
0.00	175.00	1	1.9" Fiber
0.00	175.00	3	7/8" Hybrid
0.00	175.00	1	W/G Ladder
0.00	165.00	1	1 5/8" Hybrid
0.00	165.00	1	W/G Ladder
0.00	155.00	1	1.75" Hybrid
0.00	138.00	3	1 1/4" Coax
0.00	138.00	1	5/8" Fiber
0.00	138.00	1	W/G Ladder

Base Reactions

Leg	Overturning	
Max Uplift:	-452.93 (kips)	Moment: 9745.70 (ft-kips)
Max Down:	528.19 (kips)	Total Down: 84.12 (kips)
Max Shear:	51.05 (kips)	Total Shear: 87.35 (kips)

Structure: MA12227-A-SBA

Site Name: Truro	Code: TIA-222-G	10/26/2023
Type: Self Support	Basic WS: 115.00	
Height: 190.00 (ft)	Basic Ice WS: 50.00	
Base Elev: 0.00 (ft)	Operational WS: 60.00	Page: 3
Base Shape: Triangle		
Base Width: 22.50		
Top Width: 5.41		

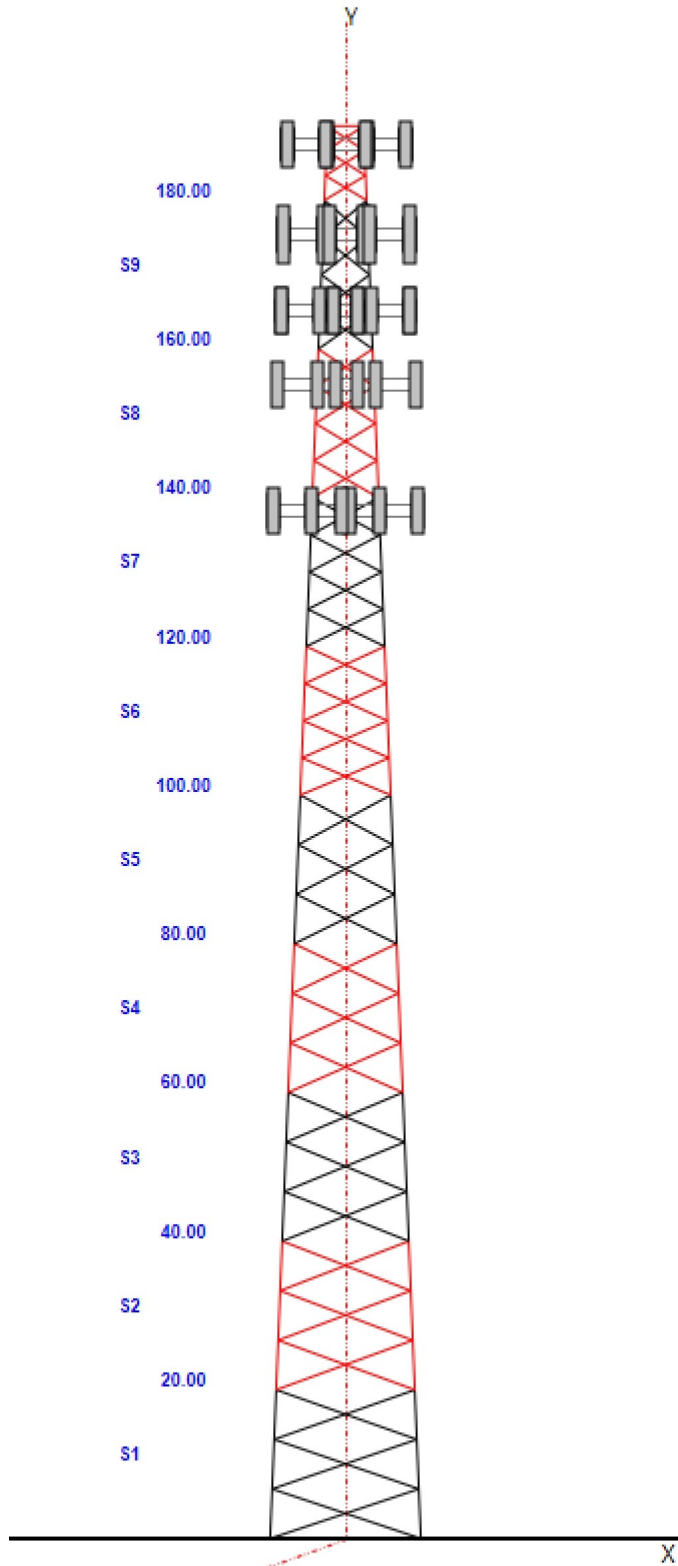

Structure: MA12227-A-SBA - Coax Line Placement

Type: Self Support
Site Name: Truro
Height: 190.00 (ft)

10/26/2023



Page: 4

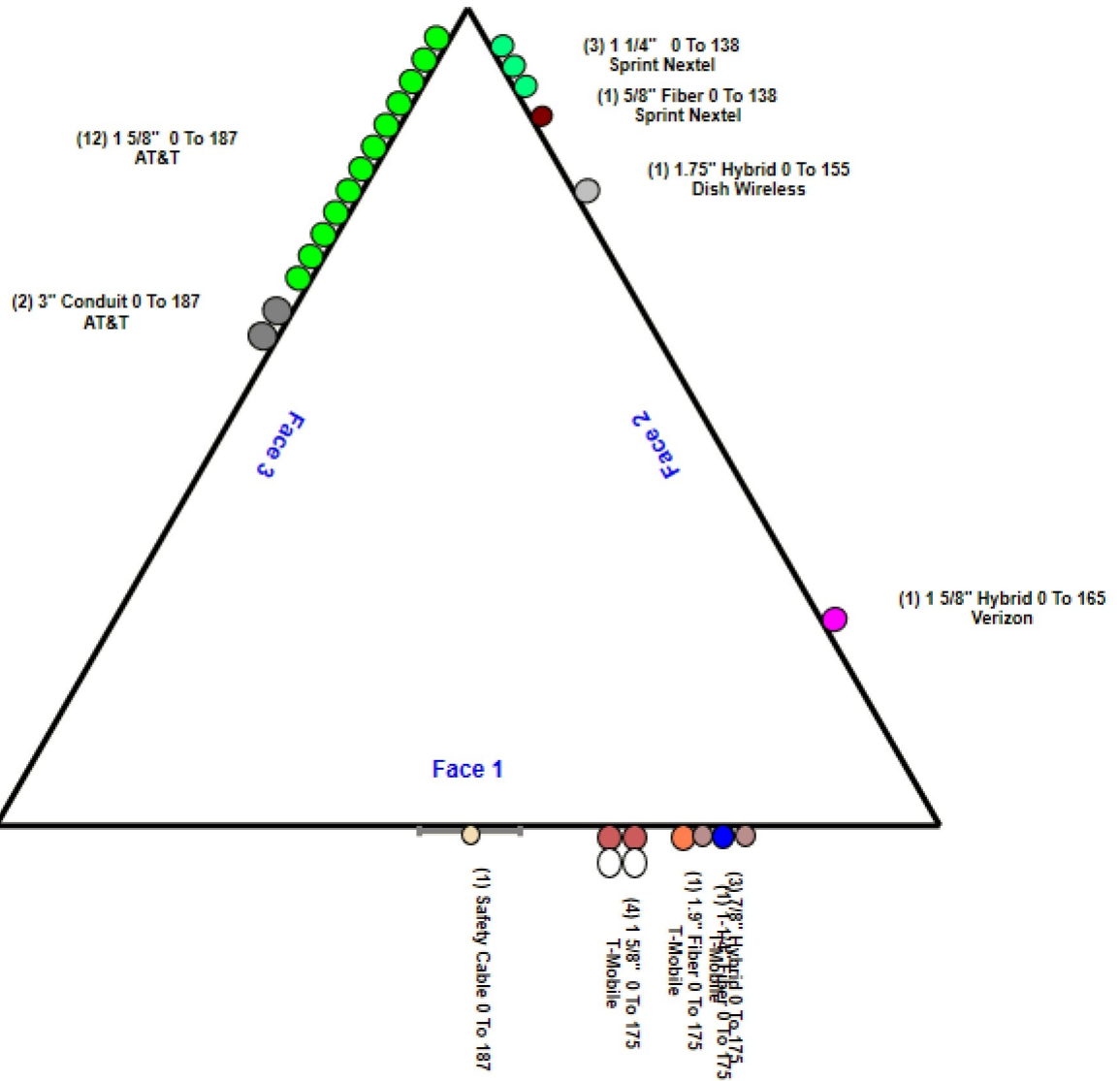

Loading Summary

Structure: MA12227-A-SBA	Code: TIA-222-G	10/26/2023
Site Name: Truro	Exposure: B	
Height: 190.00 (ft)	Crest Height: 0.00	
Base Elev: 0.000 (ft)	Site Class: D - Stiff Soil	
Gh: 0.85	Topography: 1	Struct Class: III



Page: 5

Discrete Appurtenances Properties

Attach Elev (ft)	Description	Qty	No Ice		Ice		Len (in)	Width (in)	Depth (in)	Ka	Orientation Factor	Vert Ecc (ft)
			Weight (lb)	CaAa (sf)	Weight (lb)	CaAa (sf)						
190.00	Lightning Rod	1	5.00	0.500	31.73	2.728	72.000	1.000	1.000	1.00	1.00	0.000
187.30	(3) USF12-496-U	1	1598.0	34.800	4445.96	81.316	0.000	0.000	0.000	0.75	1.00	0.000
187.30	AM-X-CD-16-65-00T-RET	3	48.50	7.080	255.65	10.228	72.000	11.800	5.900	0.80	0.75	0.000
187.30	Cci - DMP5R-BU4DA	3	20.30	8.280	280.17	9.844	48.000	20.700	7.700	0.80	0.85	0.000
187.30	DUO1417-8686-0	3	20.30	5.640	222.59	6.912	48.400	14.000	9.000	0.80	0.82	0.000
187.30	800 10121	3	46.30	4.680	192.93	7.124	54.500	10.300	5.900	0.80	0.79	0.000
187.30	LGP17201	6	31.00	1.950	79.78	3.222	13.900	14.400	3.700	0.80	0.50	0.000
187.30	RRUS 12	3	60.00	2.700	145.55	3.542	18.200	17.800	8.000	0.80	0.50	0.000
187.30	RRUS 4478 B14	3	59.40	1.650	112.33	2.312	15.000	13.200	7.300	0.80	0.50	0.000
187.30	4449 B5/B12	3	71.00	1.970	139.14	2.669	17.900	13.200	9.400	0.80	0.50	0.000
187.30	DC6-48-60-18-8F	2	31.80	0.920	110.72	1.479	24.000	11.000	11.000	1.00	1.00	0.000
175.00	AIR 21 B2A/B4P	3	91.50	5.650	316.41	7.503	56.000	12.100	7.900	0.80	0.86	0.000
175.00	AIR 21 B4A/B2P	3	90.30	5.650	315.21	7.503	56.000	12.100	7.900	0.80	0.86	0.000
175.00	840590966	3	101.40	18.780	628.26	22.292	95.900	23.500	7.100	0.80	0.69	0.000
175.00	Ericsson KRY 112 144/1	3	11.00	0.410	24.65	1.011	6.900	6.100	2.700	0.80	0.67	0.000
175.00	Ericsson 4480 B71 + B85	3	93.00	2.850	184.05	3.704	21.800	15.700	7.500	0.80	0.50	0.000
175.00	VFA12-HD	3	774.00	18.400	1731.47	47.665	0.000	0.000	0.000	0.75	0.75	0.000
165.00	Sector Frame	3	500.00	15.500	1383.60	31.113	0.000	0.000	0.000	0.75	0.75	0.000
165.00	SWCP 2X7014	3	30.00	9.940	397.80	11.746	76.700	14.000	11.300	0.80	0.93	0.000
165.00	NHH-65B-R2B	6	43.70	7.140	312.02	9.745	72.000	11.900	7.100	0.80	0.83	0.000
165.00	MT6407-77A	3	79.40	4.690	239.29	5.904	35.100	16.100	5.500	0.80	0.70	0.000
165.00	B2/B66A RRH-BR049	3	84.40	1.880	149.28	2.578	15.000	15.000	10.000	0.80	0.50	0.000
165.00	B5/B13 RRH-BR04C (RFV01U-D2A)	3	70.30	1.880	131.86	2.578	15.000	15.000	8.100	0.80	0.50	0.000
165.00	Raycap RVZDC-6627-PF-48	1	32.00	4.060	176.20	5.100	29.500	16.500	12.600	0.80	0.67	0.000
165.00	(3) V-Braces	1	230.00	6.700	636.46	15.580	0.000	0.000	0.000	0.75	1.00	0.000
165.00	(3) Stabilizer Kit	1	180.00	6.100	466.29	14.185	0.000	0.000	0.000	0.75	1.00	0.000
165.00	Handrail Kit	1	261.72	6.750	654.85	15.100	0.000	0.000	0.000	0.75	1.00	0.000
155.00	MX08FRO665-21	3	64.50	12.100	428.09	13.874	72.000	20.000	8.000	0.80	0.74	0.000
155.00	(3) MTC3975083	1	1056.4	29.450	2346.97	75.707	0.000	0.000	0.000	0.75	1.00	0.000
155.00	TA08025-B605	3	75.00	1.960	140.38	2.661	15.800	15.000	9.100	0.80	0.50	0.000
155.00	TA08025-B604	3	63.90	1.960	127.19	2.661	15.800	15.000	7.900	0.80	0.50	0.000
155.00	RDIDC-9181-PF-48	1	21.85	2.010	88.26	2.720	16.570	14.570	8.460	1.00	1.00	0.000
138.00	T-Arm (Flat)	3	400.00	10.000	744.08	20.753	0.000	0.000	0.000	0.75	0.75	0.000
138.00	APXVTM14-C-I20	3	56.20	5.910	251.17	7.186	56.300	12.600	6.300	0.80	0.77	0.000
138.00	APXVSP18-C	3	57.00	7.080	269.99	10.119	72.000	11.800	7.000	0.80	0.83	0.000
138.00	1900MHz RRH	3	44.00	2.500	178.52	3.627	23.000	13.000	17.000	0.80	0.50	0.000
138.00	1900MHz RRH	3	44.00	2.500	178.52	3.627	23.000	13.000	17.000	0.80	0.50	0.000
138.00	800 MHz RRH	3	53.00	2.130	144.14	3.336	19.700	13.000	10.800	0.80	0.50	0.000
138.00	ALU 800MHz External Notch Filt	3	8.80	0.780	30.54	1.577	10.000	8.000	3.000	0.80	0.50	0.000
138.00	ACU-A20-N	4	1.00	0.140	6.29	0.506	4.000	2.000	3.500	0.80	0.50	0.000
Totals:		110	13,253.28		39,472.65						Number of Appurtenances :	40

Loading Summary

Structure: MA12227-A-SBA	Code: TIA-222-G	10/26/2023
Site Name: Truro	Exposure: B	
Height: 190.00 (ft)	Crest Height: 0.00	
Base Elev: 0.000 (ft)	Site Class: D - Stiff Soil	
Gh: 0.85	Topography: 1	Struct Class: III



Page: 6

Linear Appurtenances Properties

Elev. From (ft)	Elev. To (ft)	Description	Qty	Width (in)	Weight (lb/ft)	Pct In Block	Spread On Faces	Bundling Arrangement	Cluster Dia (in)	Out of Zone	Spacing (in)	Orientation Factor	Ka Override
0.00	187.30	1 5/8" Coax	12	1.98	1.04	100.00	3	Individual IR		N	1.00	1.00	
0.00	187.30	3" Conduit	2	3.02	1.78	100.00	3	Individual IR		N	1.00	1.00	
0.00	187.30	3/4" DC	4	0.75	0.40	100.00	3	Individual NR		N	1.00	1.00	0
0.00	187.30	7/16" Fiber	2	0.44	0.16	100.00	3	Individual NR		N	1.00	1.00	0
0.00	187.30	Climbing Ladder	1	3.00	6.90	100.00	1	Individual NR		N	1.00	1.00	
0.00	187.30	Safety Cable	1	0.38	0.27	100.00	1	Individual NR		N	1.00	1.00	
0.00	187.30	W/G Ladder	1	1.50	6.00	100.00	3	Individual NR		N	1.00	1.00	
0.00	175.00	1 5/8" Coax	4	1.98	1.04	50.00	1	Block		N	0.25	0.78	
0.00	175.00	1-1/4" Fiber	1	1.25	0.95	100.00	1	Individual NR		N	1.00	1.00	
0.00	175.00	1.9" Fiber	1	1.90	0.95	100.00	1	Individual NR		N	1.00	1.00	
0.00	175.00	7/8" Hybrid	3	0.88	0.65	100.00	1	Individual IR		N	1.00	0.67	
0.00	175.00	W/G Ladder	1	2.00	6.00	100.00	1	Individual NR		N	1.00	1.00	
0.00	165.00	1 5/8" Hybrid	1	1.98	1.04	100.00	2	Individual IR		N	1.00	0.67	
0.00	165.00	W/G Ladder	1	2.00	6.00	100.00	2	Individual NR		N	1.00	1.00	
0.00	155.00	1.75" Hybrid	1	1.75	1.99	100.00	2	Individual NR		N	1.00	1.00	
0.00	138.00	1 1/4" Coax	3	1.55	0.66	100.00	2	Individual IR		N	1.00	0.65	
0.00	138.00	5/8" Fiber	1	0.63	0.15	100.00	2	Individual NR		N	1.00	1.00	
0.00	138.00	W/G Ladder	1	2.00	6.00	100.00	1	Individual NR		N	1.00	1.00	

Section Forces

Structure: MA12227-A-SBA
Site Name: Truro
Height: 190.00 (ft)
Base Elev: 0.000 (ft)
Gh: 0.85

Topography: 1

Code: TIA-222-G
Exposure: B
Crest Height: 0.00
Site Class: D - Stiff Soil
Struct Class: III

10/26/2023

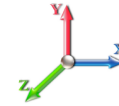

Page: 7

Load Case: 1.2D + 1.6W Normal Wind

1.2D + 1.6W 115 mph Wind at Normal To Face

Wind Load Factor: 1.60
Dead Load Factor: 1.20
Ice Dead Load Factor: 0.00

Wind Importance Factor: 1.15
Ice Importance Factor: 1.25

Sect Seq	Wind Height (ft)	qz (psf)	Total Flat Area (sqft)	Total Round Area (sqft)	Ice Round Area (sqft)	Sol Ratio	Cf	Df	Dr	Ice Thick (in)	Eff Area (sqft)	Linear Area (sqft)	Linear Area (sqft)	Total Weight (lb)	Weight Ice (lb)	Struct Force (lb)	Linear Force (lb)	Total Force (lb)
1	10.0	23.17	44.336	17.52	0.00	0.14	2.81	1.00	1.00	0.00	53.17	105.94	0.00	10,028.	0.0	4702.34	2519.62	7,221.95
2	30.0	23.19	40.911	17.52	0.00	0.14	2.79	1.00	1.00	0.00	49.76	105.94	0.00	9,784.7	0.0	4381.05	2521.74	6,902.79
3	50.0	26.83	37.553	16.69	0.00	0.15	2.78	1.00	1.00	0.00	45.90	105.94	0.00	9,049.0	0.0	4658.98	2918.01	7,576.99
4	70.0	29.54	29.932	16.69	0.00	0.14	2.81	1.00	1.00	0.00	38.07	105.94	0.00	8,507.3	0.0	4293.46	3212.46	7,505.92
5	90.0	31.73	27.076	15.85	0.00	0.15	2.79	1.00	1.00	0.00	34.89	105.94	0.00	7,831.3	0.0	4200.37	3451.61	7,651.98
6	110.0	33.61	26.395	14.19	0.00	0.16	2.75	1.00	1.00	0.00	33.68	105.94	0.00	6,424.1	0.0	4228.70	3655.29	7,883.99
7	130.0	35.25	19.279	13.35	0.00	0.15	2.78	1.00	1.00	0.00	26.20	106.39	0.00	5,964.4	0.0	3496.91	3943.21	7,440.12
8	150.0	36.72	16.640	12.52	0.00	0.16	2.75	1.00	1.00	0.00	23.26	94.75	0.00	4,908.5	0.0	3191.86	3616.98	6,808.84
9	170.0	38.06	14.129	11.68	0.00	0.17	2.69	1.00	1.00	0.00	20.45	82.58	0.00	4,177.8	0.0	2849.36	3214.22	6,063.58
10	185.0	38.99	7.341	5.01	0.00	0.20	2.59	1.00	1.00	0.00	10.19	24.06	0.00	1,542.3	0.0	1398.52	940.61	2,339.13
														68,218.1	0.0			67,395.30

Load Case: 1.2D + 1.6W 60° Wind

1.2D + 1.6W 115 mph Wind at 60° From Face

Wind Load Factor: 1.60
Dead Load Factor: 1.20
Ice Dead Load Factor: 0.00

Wind Importance Factor: 1.15
Ice Importance Factor: 1.25

Sect Seq	Wind Height (ft)	qz (psf)	Total Flat Area (sqft)	Total Round Area (sqft)	Ice Round Area (sqft)	Sol Ratio	Cf	Df	Dr	Ice Thick (in)	Eff Area (sqft)	Linear Area (sqft)	Linear Area (sqft)	Total Weight (lb)	Weight Ice (lb)	Struct Force (lb)	Linear Force (lb)	Total Force (lb)
1	10.0	23.17	44.336	17.52	0.00	0.14	2.81	0.80	1.00	0.00	44.30	105.94	0.00	10,028.	0.0	3918.07	2519.62	6,437.68
2	30.0	23.19	40.911	17.52	0.00	0.14	2.79	0.80	1.00	0.00	41.58	105.94	0.00	9,784.7	0.0	3660.62	2521.74	6,182.37
3	50.0	26.83	37.553	16.69	0.00	0.15	2.78	0.80	1.00	0.00	38.39	105.94	0.00	9,049.0	0.0	3896.71	2918.01	6,814.72
4	70.0	29.54	29.932	16.69	0.00	0.14	2.81	0.80	1.00	0.00	32.08	105.94	0.00	8,507.3	0.0	3618.33	3212.46	6,830.78
5	90.0	31.73	27.076	15.85	0.00	0.15	2.79	0.80	1.00	0.00	29.47	105.94	0.00	7,831.3	0.0	3548.36	3451.61	6,999.96
6	110.0	33.61	26.395	14.19	0.00	0.16	2.75	0.80	1.00	0.00	28.40	105.94	0.00	6,424.1	0.0	3565.85	3655.29	7,221.14
7	130.0	35.25	19.279	13.35	0.00	0.15	2.78	0.80	1.00	0.00	22.34	106.39	0.00	5,964.4	0.0	2982.24	3943.21	6,925.45
8	150.0	36.72	16.640	12.52	0.00	0.16	2.75	0.80	1.00	0.00	19.93	94.75	0.00	4,908.5	0.0	2735.20	3616.98	6,352.17
9	170.0	38.06	14.129	11.68	0.00	0.17	2.69	0.80	1.00	0.00	17.63	82.58	0.00	4,177.8	0.0	2455.71	3214.22	5,669.94
10	185.0	38.99	7.341	5.01	0.00	0.20	2.59	0.80	1.00	0.00	8.72	24.06	0.00	1,542.3	0.0	1197.02	940.61	2,137.63
														68,218.1	0.0			61,571.85

Section Forces

Structure: MA12227-A-SBA
Site Name: Truro
Height: 190.00 (ft)
Base Elev: 0.000 (ft)
Gh: 0.85

Topography: 1

Code: TIA-222-G
Exposure: B
Crest Height: 0.00
Site Class: D - Stiff Soil
Struct Class: III

10/26/2023

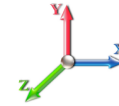

Page: 8

Load Case: 1.2D + 1.6W 90° Wind	1.2D + 1.6W 115 mph Wind at 90° From Face
Wind Load Factor: 1.60	Wind Importance Factor: 1.15
Dead Load Factor: 1.20	
Ice Dead Load Factor: 0.00	Ice Importance Factor: 1.25

Sect Seq	Wind Height (ft)	qz (psf)	Total Area		Ice Round Area (sqft)	Sol Ratio	Cf	Df	Dr	Ice Thick (in)	Eff Area (sqft)	Ice Area		Total Weight (lb)	Weight Ice (lb)	Struct Force (lb)	Linear Force (lb)	Total Force (lb)
			Flat Area (sqft)	Round Area (sqft)								Linear Area (sqft)	Linear Area (sqft)					
1	10.0	23.17	44.336	17.52	0.00	0.14	2.81	0.85	1.00	0.00	46.52	105.94	0.00	10,028.	0.0	4114.13	2519.62	6,633.75
2	30.0	23.19	40.911	17.52	0.00	0.14	2.79	0.85	1.00	0.00	43.62	105.94	0.00	9,784.7	0.0	3840.73	2521.74	6,362.47
3	50.0	26.83	37.553	16.69	0.00	0.15	2.78	0.85	1.00	0.00	40.27	105.94	0.00	9,049.0	0.0	4087.28	2918.01	7,005.28
4	70.0	29.54	29.932	16.69	0.00	0.14	2.81	0.85	1.00	0.00	33.58	105.94	0.00	8,507.3	0.0	3787.11	3212.46	6,999.57
5	90.0	31.73	27.076	15.85	0.00	0.15	2.79	0.85	1.00	0.00	30.82	105.94	0.00	7,831.3	0.0	3711.36	3451.61	7,162.97
6	110.0	33.61	26.395	14.19	0.00	0.16	2.75	0.85	1.00	0.00	29.72	105.94	0.00	6,424.1	0.0	3731.56	3655.29	7,386.85
7	130.0	35.25	19.279	13.35	0.00	0.15	2.78	0.85	1.00	0.00	23.31	106.39	0.00	5,964.4	0.0	3110.91	3943.21	7,054.12
8	150.0	36.72	16.640	12.52	0.00	0.16	2.75	0.85	1.00	0.00	20.77	94.75	0.00	4,908.5	0.0	2849.36	3616.98	6,466.34
9	170.0	38.06	14.129	11.68	0.00	0.17	2.69	0.85	1.00	0.00	18.34	82.58	0.00	4,177.8	0.0	2554.12	3214.22	5,768.35
10	185.0	38.99	7.341	5.01	0.00	0.20	2.59	0.85	1.00	0.00	9.09	24.06	0.00	1,542.3	0.0	1247.40	940.61	2,188.01
														68,218.1	0.0			63,027.71

Load Case: 0.9D + 1.6W Normal Wind	0.9D + 1.6W 115 mph Wind at Normal To Face
Wind Load Factor: 1.60	Wind Importance Factor: 1.15
Dead Load Factor: 0.90	
Ice Dead Load Factor: 0.00	Ice Importance Factor: 1.25

Sect Seq	Wind Height (ft)	qz (psf)	Total Area		Ice Round Area (sqft)	Sol Ratio	Cf	Df	Dr	Ice Thick (in)	Eff Area (sqft)	Ice Area		Total Weight (lb)	Weight Ice (lb)	Struct Force (lb)	Linear Force (lb)	Total Force (lb)
			Flat Area (sqft)	Round Area (sqft)								Linear Area (sqft)	Linear Area (sqft)					
1	10.0	23.17	44.336	17.52	0.00	0.14	2.81	1.00	1.00	0.00	53.17	105.94	0.00	7,521.6	0.0	4702.34	2519.62	7,221.95
2	30.0	23.19	40.911	17.52	0.00	0.14	2.79	1.00	1.00	0.00	49.76	105.94	0.00	7,338.5	0.0	4381.05	2521.74	6,902.79
3	50.0	26.83	37.553	16.69	0.00	0.15	2.78	1.00	1.00	0.00	45.90	105.94	0.00	6,786.7	0.0	4658.98	2918.01	7,576.99
4	70.0	29.54	29.932	16.69	0.00	0.14	2.81	1.00	1.00	0.00	38.07	105.94	0.00	6,380.4	0.0	4293.46	3212.46	7,505.92
5	90.0	31.73	27.076	15.85	0.00	0.15	2.79	1.00	1.00	0.00	34.89	105.94	0.00	5,873.5	0.0	4200.37	3451.61	7,651.98
6	110.0	33.61	26.395	14.19	0.00	0.16	2.75	1.00	1.00	0.00	33.68	105.94	0.00	4,818.1	0.0	4228.70	3655.29	7,883.99
7	130.0	35.25	19.279	13.35	0.00	0.15	2.78	1.00	1.00	0.00	26.20	106.39	0.00	4,473.3	0.0	3496.91	3943.21	7,440.12
8	150.0	36.72	16.640	12.52	0.00	0.16	2.75	1.00	1.00	0.00	23.26	94.75	0.00	3,681.4	0.0	3191.86	3616.98	6,808.84
9	170.0	38.06	14.129	11.68	0.00	0.17	2.69	1.00	1.00	0.00	20.45	82.58	0.00	3,133.3	0.0	2849.36	3214.22	6,063.58
10	185.0	38.99	7.341	5.01	0.00	0.20	2.59	1.00	1.00	0.00	10.19	24.06	0.00	1,156.7	0.0	1398.52	940.61	2,339.13
														51,163.6	0.0			67,395.30

Section Forces

Structure: MA12227-A-SBA
Site Name: Truro
Height: 190.00 (ft)
Base Elev: 0.000 (ft)
Gh: 0.85

Topography: 1

Code: TIA-222-G
Exposure: B
Crest Height: 0.00
Site Class: D - Stiff Soil
Struct Class: III

10/26/2023

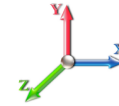

Page: 9

Load Case: 0.9D + 1.6W 60° Wind

0.9D + 1.6W 115 mph Wind at 60° From Face

Wind Load Factor: 1.60
Dead Load Factor: 0.90
Ice Dead Load Factor: 0.00

Wind Importance Factor: 1.15
Ice Importance Factor: 1.25

Sect Seq	Wind Height (ft)	qz (psf)	Total Flat Area (sqft)	Total Round Area (sqft)	Ice Round Area (sqft)	Sol Ratio	Cf	Df	Dr	Ice Thick (in)	Eff Area (sqft)	Linear Area (sqft)	Linear Area (sqft)	Total Weight (lb)	Weight Ice (lb)	Struct Force (lb)	Linear Force (lb)	Total Force (lb)
1	10.0	23.17	44.336	17.52	0.00	0.14	2.81	0.80	1.00	0.00	44.30	105.94	0.00	7,521.6	0.0	3918.07	2519.62	6,437.68
2	30.0	23.19	40.911	17.52	0.00	0.14	2.79	0.80	1.00	0.00	41.58	105.94	0.00	7,338.5	0.0	3660.62	2521.74	6,182.37
3	50.0	26.83	37.553	16.69	0.00	0.15	2.78	0.80	1.00	0.00	38.39	105.94	0.00	6,786.7	0.0	3896.71	2918.01	6,814.72
4	70.0	29.54	29.932	16.69	0.00	0.14	2.81	0.80	1.00	0.00	32.08	105.94	0.00	6,380.4	0.0	3618.33	3212.46	6,830.78
5	90.0	31.73	27.076	15.85	0.00	0.15	2.79	0.80	1.00	0.00	29.47	105.94	0.00	5,873.5	0.0	3548.36	3451.61	6,999.96
6	110.0	33.61	26.395	14.19	0.00	0.16	2.75	0.80	1.00	0.00	28.40	105.94	0.00	4,818.1	0.0	3565.85	3655.29	7,221.14
7	130.0	35.25	19.279	13.35	0.00	0.15	2.78	0.80	1.00	0.00	22.34	106.39	0.00	4,473.3	0.0	2982.24	3943.21	6,925.45
8	150.0	36.72	16.640	12.52	0.00	0.16	2.75	0.80	1.00	0.00	19.93	94.75	0.00	3,681.4	0.0	2735.20	3616.98	6,352.17
9	170.0	38.06	14.129	11.68	0.00	0.17	2.69	0.80	1.00	0.00	17.63	82.58	0.00	3,133.3	0.0	2455.71	3214.22	5,669.94
10	185.0	38.99	7.341	5.01	0.00	0.20	2.59	0.80	1.00	0.00	8.72	24.06	0.00	1,156.7	0.0	1197.02	940.61	2,137.63
														51,163.6	0.0			61,571.85

Load Case: 0.9D + 1.6W 90° Wind

0.9D + 1.6W 115 mph Wind at 90° From Face

Wind Load Factor: 1.60
Dead Load Factor: 0.90
Ice Dead Load Factor: 0.00

Wind Importance Factor: 1.15
Ice Importance Factor: 1.25

Sect Seq	Wind Height (ft)	qz (psf)	Total Flat Area (sqft)	Total Round Area (sqft)	Ice Round Area (sqft)	Sol Ratio	Cf	Df	Dr	Ice Thick (in)	Eff Area (sqft)	Linear Area (sqft)	Linear Area (sqft)	Total Weight (lb)	Weight Ice (lb)	Struct Force (lb)	Linear Force (lb)	Total Force (lb)
1	10.0	23.17	44.336	17.52	0.00	0.14	2.81	0.85	1.00	0.00	46.52	105.94	0.00	7,521.6	0.0	4114.13	2519.62	6,633.75
2	30.0	23.19	40.911	17.52	0.00	0.14	2.79	0.85	1.00	0.00	43.62	105.94	0.00	7,338.5	0.0	3840.73	2521.74	6,362.47
3	50.0	26.83	37.553	16.69	0.00	0.15	2.78	0.85	1.00	0.00	40.27	105.94	0.00	6,786.7	0.0	4087.28	2918.01	7,005.28
4	70.0	29.54	29.932	16.69	0.00	0.14	2.81	0.85	1.00	0.00	33.58	105.94	0.00	6,380.4	0.0	3787.11	3212.46	6,999.57
5	90.0	31.73	27.076	15.85	0.00	0.15	2.79	0.85	1.00	0.00	30.82	105.94	0.00	5,873.5	0.0	3711.36	3451.61	7,162.97
6	110.0	33.61	26.395	14.19	0.00	0.16	2.75	0.85	1.00	0.00	29.72	105.94	0.00	4,818.1	0.0	3731.56	3655.29	7,386.85
7	130.0	35.25	19.279	13.35	0.00	0.15	2.78	0.85	1.00	0.00	23.31	106.39	0.00	4,473.3	0.0	3110.91	3943.21	7,054.12
8	150.0	36.72	16.640	12.52	0.00	0.16	2.75	0.85	1.00	0.00	20.77	94.75	0.00	3,681.4	0.0	2849.36	3616.98	6,466.34
9	170.0	38.06	14.129	11.68	0.00	0.17	2.69	0.85	1.00	0.00	18.34	82.58	0.00	3,133.3	0.0	2554.12	3214.22	5,768.35
10	185.0	38.99	7.341	5.01	0.00	0.20	2.59	0.85	1.00	0.00	9.09	24.06	0.00	1,156.7	0.0	1247.40	940.61	2,188.01
														51,163.6	0.0			63,027.71

Section Forces

Structure: MA12227-A-SBA	Code: TIA-222-G	10/26/2023
Site Name: Truro	Exposure: B	
Height: 190.00 (ft)	Crest Height: 0.00	
Base Elev: 0.000 (ft)	Site Class: D - Stiff Soil	
Gh: 0.85	Topography: 1	Struct Class: III
		Page: 10



Load Case: 1.2D + 1.0Di + 1.0Wi Normal Wind	1.2D + 1.0Di + 1.0Wi 50 mph Wind at Normal From Face
Wind Load Factor: 1.00	Wind Importance Factor: 1.00
Dead Load Factor: 1.20	
Ice Dead Load Factor: 1.00	Ice Importance Factor: 1.25

Sect Seq	Wind Height (ft)	qz (psf)	Total Flat Area	Total Round Area	Ice Round Area	Sol Ratio	Cf	Df	Dr	Ice Thick (in)	Eff Area (sqft)	Linear Area	Linear Area	Total Weight (lb)	Weight Ice (lb)	Struct Force (lb)	Linear Force (lb)	Total Force (lb)	
			(sqft)	(sqft)	(sqft)							(sqft)	(sqft)						(sqft)
1	10.0	3.81	44.336	66.25	48.72	0.25	2.44	1.00	1.00	1.66	83.06	193.62	61.01	20,663.	10634.3	657.07	625.50	1,282.57	
2	30.0	3.81	40.911	68.72	51.20	0.27	2.39	1.00	1.00	1.86	81.41	194.52	74.29	21,516.	11731.5	629.81	662.57	1,292.39	
3	50.0	4.41	37.553	67.26	50.57	0.28	2.35	1.00	1.00	1.95	77.43	197.76	78.18	21,056.	12007.1	682.54	781.97	1,464.52	
4	70.0	4.86	29.932	65.60	48.91	0.28	2.35	1.00	1.00	2.02	68.86	199.99	80.86	20,064.	11557.6	666.62	874.07	1,540.69	
5	90.0	5.22	27.076	62.59	46.74	0.30	2.31	1.00	1.00	2.07	64.49	201.70	82.92	19,296.	11465.0	659.53	946.33	1,605.85	
6	110.0	5.52	26.395	66.53	52.35	0.35	2.17	1.00	1.00	2.11	67.36	203.10	84.60	18,173.	11749.0	687.47	995.33	1,682.80	
7	130.0	5.79	19.279	61.84	48.49	0.35	2.16	1.00	1.00	2.15	57.44	201.31	85.30	16,833.	10869.4	612.45	1036.58	1,649.03	
8	150.0	6.04	16.640	57.04	44.52	0.38	2.10	1.00	1.00	2.18	52.47	174.59	78.17	14,674.	9765.7	566.24	931.17	1,497.41	
9	170.0	6.26	14.129	52.26	40.58	0.42	2.02	1.00	1.00	2.21	47.90	151.28	64.43	12,696.	8518.8	514.92	762.57	1,277.50	
10	185.0	6.41	7.341	29.46	24.45	0.57	1.83	1.00	1.00	2.23	28.67	41.60	18.97	4,840.7	3298.4	285.40	156.70	442.10	
														169,814.9	101596.7				13,734.86

Load Case: 1.2D + 1.0Di + 1.0Wi 60° Wind	1.2D + 1.0Di + 1.0Wi 50 mph Wind at 60° From Face
Wind Load Factor: 1.00	Wind Importance Factor: 1.00
Dead Load Factor: 1.20	
Ice Dead Load Factor: 1.00	Ice Importance Factor: 1.25

Sect Seq	Wind Height (ft)	qz (psf)	Total Flat Area	Total Round Area	Ice Round Area	Sol Ratio	Cf	Df	Dr	Ice Thick (in)	Eff Area (sqft)	Linear Area	Linear Area	Total Weight (lb)	Weight Ice (lb)	Struct Force (lb)	Linear Force (lb)	Total Force (lb)	
			(sqft)	(sqft)	(sqft)							(sqft)	(sqft)						
1	10.0	3.81	44.336	66.25	48.72	0.25	2.44	0.80	1.00	1.66	74.19	193.62	61.01	20,663.	10634.3	586.92	625.50	1,212.42	
2	30.0	3.81	40.911	68.72	51.20	0.27	2.39	0.80	1.00	1.86	73.23	194.52	74.29	21,516.	11731.5	566.51	662.57	1,229.09	
3	50.0	4.41	37.553	67.26	50.57	0.28	2.35	0.80	1.00	1.95	69.92	197.76	78.18	21,056.	12007.1	616.34	781.97	1,398.31	
4	70.0	4.86	29.932	65.60	48.91	0.28	2.35	0.80	1.00	2.02	62.88	199.99	80.86	20,064.	11557.6	608.67	874.07	1,482.74	
5	90.0	5.22	27.076	62.59	46.74	0.30	2.31	0.80	1.00	2.07	59.07	201.70	82.92	19,296.	11465.0	604.14	946.33	1,550.47	
6	110.0	5.52	26.395	66.53	52.35	0.35	2.17	0.80	1.00	2.11	62.08	203.10	84.60	18,173.	11749.0	633.60	995.33	1,628.93	
7	130.0	5.79	19.279	61.84	48.49	0.35	2.16	0.80	1.00	2.15	53.59	201.31	85.30	16,833.	10869.4	571.34	1036.58	1,607.92	
8	150.0	6.04	16.640	57.04	44.52	0.38	2.10	0.80	1.00	2.18	49.14	174.59	78.17	14,674.	9765.7	530.32	931.17	1,461.49	
9	170.0	6.26	14.129	52.26	40.58	0.42	2.02	0.80	1.00	2.21	45.08	151.28	64.43	12,696.	8518.8	484.55	762.57	1,247.12	
10	185.0	6.41	7.341	29.46	24.45	0.57	1.83	0.80	1.00	2.23	27.21	41.60	18.97	4,840.7	3298.4	270.79	156.70	427.49	
														169,814.9	101596.7				13,245.98

Section Forces

Structure: MA12227-A-SBA	Code: TIA-222-G	10/26/2023
Site Name: Truro	Exposure: B	
Height: 190.00 (ft)	Crest Height: 0.00	
Base Elev: 0.000 (ft)	Site Class: D - Stiff Soil	
Gh: 0.85	Topography: 1	Struct Class: III

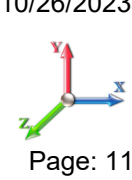

Page: 11

Load Case: 1.2D + 1.0Di + 1.0Wi 90° Wind	1.2D + 1.0Di + 1.0Wi 50 mph Wind at 90° From Face
Wind Load Factor: 1.00	Wind Importance Factor: 1.00
Dead Load Factor: 1.20	
Ice Dead Load Factor: 1.00	Ice Importance Factor: 1.25

Sect Seq	Wind Height (ft)	qz (psf)	Total		Ice Round Area (sqft)	Sol Ratio	Cf	Df	Dr	Ice Thick (in)	Eff Area (sqft)	Ice		Total Weight (lb)	Weight Ice (lb)	Struct Force (lb)	Linear Force (lb)	Total Force (lb)
			Flat Area (sqft)	Round Area (sqft)								Area (sqft)	Area (sqft)					
1	10.0	3.81	44.336	66.25	48.72	0.25	2.44	0.85	1.00	1.66	76.40	193.62	61.01	20,663.	10634.3	604.45	625.50	1,229.96
2	30.0	3.81	40.911	68.72	51.20	0.27	2.39	0.85	1.00	1.86	75.27	194.52	74.29	21,516.	11731.5	582.34	662.57	1,244.91
3	50.0	4.41	37.553	67.26	50.57	0.28	2.35	0.85	1.00	1.95	71.79	197.76	78.18	21,056.	12007.1	632.89	781.97	1,414.86
4	70.0	4.86	29.932	65.60	48.91	0.28	2.35	0.85	1.00	2.02	64.37	199.99	80.86	20,064.	11557.6	623.15	874.07	1,497.22
5	90.0	5.22	27.076	62.59	46.74	0.30	2.31	0.85	1.00	2.07	60.43	201.70	82.92	19,296.	11465.0	617.99	946.33	1,564.32
6	110.0	5.52	26.395	66.53	52.35	0.35	2.17	0.85	1.00	2.11	63.40	203.10	84.60	18,173.	11749.0	647.07	995.33	1,642.40
7	130.0	5.79	19.279	61.84	48.49	0.35	2.16	0.85	1.00	2.15	54.55	201.31	85.30	16,833.	10869.4	581.62	1036.58	1,618.20
8	150.0	6.04	16.640	57.04	44.52	0.38	2.10	0.85	1.00	2.18	49.97	174.59	78.17	14,674.	9765.7	539.30	931.17	1,470.47
9	170.0	6.26	14.129	52.26	40.58	0.42	2.02	0.85	1.00	2.21	45.78	151.28	64.43	12,696.	8518.8	492.14	762.57	1,254.72
10	185.0	6.41	7.341	29.46	24.45	0.57	1.83	0.85	1.00	2.23	27.57	41.60	18.97	4,840.7	3298.4	274.44	156.70	431.14
														169,814.9	101596.7			13,368.20

Load Case: 1.0D + 1.0W Normal Wind	1.0D + 1.0W 60 mph Wind at Normal To Face
Wind Load Factor: 1.00	Wind Importance Factor: 1.00
Dead Load Factor: 1.00	
Ice Dead Load Factor: 0.00	Ice Importance Factor: 1.25

Sect Seq	Wind Height (ft)	qz (psf)	Total		Ice Round Area (sqft)	Sol Ratio	Cf	Df	Dr	Ice Thick (in)	Eff Area (sqft)	Ice		Total Weight (lb)	Weight Ice (lb)	Struct Force (lb)	Linear Force (lb)	Total Force (lb)
			Flat Area (sqft)	Round Area (sqft)								Area (sqft)	Area (sqft)					
1	10.0	5.48	44.336	17.52	0.00	0.14	2.81	1.00	1.00	0.00	54.27	105.94	0.00	8,357.4	0.0	710.05	372.75	1,082.81
2	30.0	5.49	40.911	17.52	0.00	0.14	2.79	1.00	1.00	0.00	50.85	105.94	0.00	8,153.9	0.0	662.32	373.07	1,035.39
3	50.0	6.35	37.553	16.69	0.00	0.15	2.78	1.00	1.00	0.00	47.02	105.94	0.00	7,540.8	0.0	706.01	431.69	1,137.70
4	70.0	6.99	29.932	16.69	0.00	0.14	2.81	1.00	1.00	0.00	39.39	105.94	0.00	7,089.4	0.0	657.18	475.25	1,132.43
5	90.0	7.51	27.076	15.85	0.00	0.15	2.79	1.00	1.00	0.00	36.07	105.94	0.00	6,526.1	0.0	642.45	510.63	1,153.08
6	110.0	7.96	26.395	14.19	0.00	0.16	2.75	1.00	1.00	0.00	34.46	105.94	0.00	5,353.5	0.0	640.06	540.77	1,180.83
7	130.0	8.34	19.279	13.35	0.00	0.15	2.78	1.00	1.00	0.00	26.85	104.73	0.00	4,970.3	0.0	530.24	559.87	1,090.12
8	150.0	8.69	16.640	12.52	0.00	0.16	2.75	1.00	1.00	0.00	23.75	93.08	0.00	4,090.4	0.0	482.19	510.63	992.82
9	170.0	9.01	14.129	11.68	0.00	0.17	2.69	1.00	1.00	0.00	20.79	80.92	0.00	3,481.5	0.0	428.45	450.15	878.61
10	185.0	9.23	7.341	5.01	0.00	0.20	2.59	1.00	1.00	0.00	10.22	23.45	0.00	1,285.2	0.0	207.49	129.67	337.17
														56,848.4	0.0			10,020.94

Section Forces

Structure: MA12227-A-SBA

Code: TIA-222-G

10/26/2023

Site Name: Truro

Exposure: B

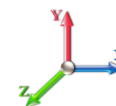

Height: 190.00 (ft)

Crest Height: 0.00

Base Elev: 0.000 (ft)

Site Class: D - Stiff Soil

Gh: 0.85

Topography: 1

Struct Class: III

Page: 12

Load Case: 1.0D + 1.0W 60° Wind

1.0D + 1.0W 60 mph Wind at 60° From Face

Wind Load Factor: 1.00

Wind Importance Factor: 1.00

Dead Load Factor: 1.00

Ice Dead Load Factor: 0.00

Ice Importance Factor: 1.25

Sect Seq	Wind Height (ft)	qz (psf)	Total Flat Area (sqft)	Total Round Area (sqft)	Ice Round Area (sqft)	Sol Ratio	Cf	Df	Dr	Ice Thick (in)	Eff Area (sqft)	Ice		Total Weight (lb)	Weight Ice (lb)	Struct Force (lb)	Linear Force (lb)	Total Force (lb)
												Linear Area (sqft)	Linear Area (sqft)					
1	10.0	5.48	44.336	17.52	0.00	0.14	2.81	0.80	1.00	0.00	45.40	105.94	0.00	8,357.4	0.0	594.03	372.75	966.78
2	30.0	5.49	40.911	17.52	0.00	0.14	2.79	0.80	1.00	0.00	42.66	105.94	0.00	8,153.9	0.0	555.74	373.07	928.81
3	50.0	6.35	37.553	16.69	0.00	0.15	2.78	0.80	1.00	0.00	39.51	105.94	0.00	7,540.8	0.0	593.24	431.69	1,024.93
4	70.0	6.99	29.932	16.69	0.00	0.14	2.81	0.80	1.00	0.00	33.40	105.94	0.00	7,089.4	0.0	557.30	475.25	1,032.55
5	90.0	7.51	27.076	15.85	0.00	0.15	2.79	0.80	1.00	0.00	30.65	105.94	0.00	6,526.1	0.0	545.99	510.63	1,056.62
6	110.0	7.96	26.395	14.19	0.00	0.16	2.75	0.80	1.00	0.00	29.18	105.94	0.00	5,353.5	0.0	542.00	540.77	1,082.76
7	130.0	8.34	19.279	13.35	0.00	0.15	2.78	0.80	1.00	0.00	23.00	104.73	0.00	4,970.3	0.0	454.10	559.87	1,013.98
8	150.0	8.69	16.640	12.52	0.00	0.16	2.75	0.80	1.00	0.00	20.42	93.08	0.00	4,090.4	0.0	414.63	510.63	925.26
9	170.0	9.01	14.129	11.68	0.00	0.17	2.69	0.80	1.00	0.00	17.96	80.92	0.00	3,481.5	0.0	370.22	450.15	820.37
10	185.0	9.23	7.341	5.01	0.00	0.20	2.59	0.80	1.00	0.00	8.75	23.45	0.00	1,285.2	0.0	177.68	129.67	307.36
													56,848.4	0.0	9,159.42			

Load Case: 1.0D + 1.0W 90° Wind

1.0D + 1.0W 60 mph Wind at 90° From Face

Wind Load Factor: 1.00

Wind Importance Factor: 1.00

Dead Load Factor: 1.00

Ice Dead Load Factor: 0.00

Ice Importance Factor: 1.25

Sect Seq	Wind Height (ft)	qz (psf)	Total Flat Area (sqft)	Total Round Area (sqft)	Ice Round Area (sqft)	Sol Ratio	Cf	Df	Dr	Ice Thick (in)	Eff Area (sqft)	Ice		Total Weight (lb)	Weight Ice (lb)	Struct Force (lb)	Linear Force (lb)	Total Force (lb)
												Linear Area (sqft)	Linear Area (sqft)					
1	10.0	5.48	44.336	17.52	0.00	0.14	2.81	0.85	1.00	0.00	47.62	105.94	0.00	8,357.4	0.0	623.03	372.75	995.79
2	30.0	5.49	40.911	17.52	0.00	0.14	2.79	0.85	1.00	0.00	44.71	105.94	0.00	8,153.9	0.0	582.39	373.07	955.46
3	50.0	6.35	37.553	16.69	0.00	0.15	2.78	0.85	1.00	0.00	41.39	105.94	0.00	7,540.8	0.0	621.43	431.69	1,053.12
4	70.0	6.99	29.932	16.69	0.00	0.14	2.81	0.85	1.00	0.00	34.90	105.94	0.00	7,089.4	0.0	582.27	475.25	1,057.52
5	90.0	7.51	27.076	15.85	0.00	0.15	2.79	0.85	1.00	0.00	32.01	105.94	0.00	6,526.1	0.0	570.10	510.63	1,080.74
6	110.0	7.96	26.395	14.19	0.00	0.16	2.75	0.85	1.00	0.00	30.50	105.94	0.00	5,353.5	0.0	566.51	540.77	1,107.28
7	130.0	8.34	19.279	13.35	0.00	0.15	2.78	0.85	1.00	0.00	23.96	104.73	0.00	4,970.3	0.0	473.14	559.87	1,033.01
8	150.0	8.69	16.640	12.52	0.00	0.16	2.75	0.85	1.00	0.00	21.26	93.08	0.00	4,090.4	0.0	431.52	510.63	942.15
9	170.0	9.01	14.129	11.68	0.00	0.17	2.69	0.85	1.00	0.00	18.67	80.92	0.00	3,481.5	0.0	384.77	450.15	834.93
10	185.0	9.23	7.341	5.01	0.00	0.20	2.59	0.85	1.00	0.00	9.12	23.45	0.00	1,285.2	0.0	185.14	129.67	314.81
													56,848.4	0.0	9,374.80			

Force/Stress Compression Summary

Structure: MA12227-A-SBA
Site Name: Truro
Height: 190.00 (ft)
Base Elev: 0.000 (ft)
Gh: 0.85

Topography: 1

Code: TIA-222-G
Exposure: B
Crest Height: 0.00
Site Class: D - Stiff Soil
Struct Class: III

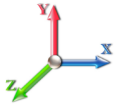
10/26/2023

 Page: 13



LEG MEMBERS

Sect	Top Elev	Member	Force (kips)	Load Case	Len (ft)	Bracing %			Fy (ksi)	Mem Cap (kips)	Leg Use %	Controls
						X	Y	Z				
1	20	SOL - 5 1/4" SOLID	-520.02	1.2D + 1.6W Normal Wind	6.68	100	100	100	61.03	50.00	741.89	70.1 Member X
2	40	SOL - 5 1/4" SOLID	-467.24	1.2D + 1.6W Normal Wind	6.68	100	100	100	61.03	50.00	741.89	63.0 Member X
3	60	SOL - 5" SOLID	-411.12	1.2D + 1.6W Normal Wind	6.68	100	100	100	64.09	50.00	654.37	62.8 Member X
4	80	SOL - 5" SOLID	-353.98	1.2D + 1.6W Normal Wind	6.68	100	100	100	64.09	50.00	654.38	54.1 Member X
5	100	SOL - 4 3/4" SOLID	-295.54	1.2D + 1.6W Normal Wind	6.68	100	100	100	67.46	50.00	571.73	51.7 Member X
6	120	SOL - 4 1/4" SOLID	-238.15	1.2D + 1.6W Normal Wind	5.01	100	100	100	56.55	50.00	505.28	47.1 Member X
7	140	SOL - 4" SOLID	-177.11	1.2D + 1.6W Normal Wind	5.01	100	100	100	60.08	50.00	434.30	40.8 Member X
8	160	SOL - 3 3/4" SOLID	-112.36	1.2D + 1.6W Normal Wind	5.01	100	100	100	64.09	50.00	368.10	30.5 Member X
9	180	SOL - 3 1/2" SOLID	-50.17	1.2D + 1.6W Normal Wind	5.01	100	100	100	68.66	50.00	306.70	16.4 Member X
10	190	SOL - 3" SOLID	-8.50	1.2D + 1.6W Normal Wind	3.34	100	100	100	53.40	50.00	258.23	3.3 Member X

Splices

Sect	Top Elev	Load Case	Top Splice				Load Case	Bottom Splice			
			Force (kips)	Cap (kips)	Use %	Bolt Type		Force (kips)	Cap (kips)	Use %	Bolt Type
1	20	1.2D + 1.6W Normal Wind	475.69	0.00	0.0		1.2D + 1.6W Normal Wind	529.26	0.00		
2	40	1.2D + 1.6W Normal Wind	420.17	0.00	0.0		1.2D + 1.6W Normal Wind	475.69	0.00	1/2 A325	6
3	60	1.2D + 1.6W Normal Wind	363.22	0.00	0.0		1.2D + 1.6W Normal Wind	420.17	0.00	1/2 A325	6
4	80	1.2D + 1.6W Normal Wind	305.14	0.00	0.0		1.2D + 1.6W Normal Wind	363.22	0.00	1/2 A325	6
5	100	1.2D + 1.6W Normal Wind	245.41	0.00	0.0		1.2D + 1.6W Normal Wind	305.14	0.00	1/2 A325	6
6	120	1.2D + 1.6W Normal Wind	184.54	0.00	0.0		1.2D + 1.6W Normal Wind	245.41	0.00	3/8 A325	6
7	140	1.2D + 1.6W Normal Wind	120.57	0.00	0.0		1.2D + 1.6W Normal Wind	184.54	0.00	3/8 A325	6
8	160	1.2D + 1.6W Normal Wind	57.74	0.00	0.0		1.2D + 1.6W Normal Wind	120.57	0.00	3/8 A325	6
9	180	1.2D + 1.6W Normal Wind	10.58	0.00	0.0		1.2D + 1.6W Normal Wind	57.74	0.00	3/8 A325	6
10	190	1.2D + 1.0Di + 1.0Wi 90° Wind	0.57	0.00	0.0		1.2D + 1.6W Normal Wind	10.58	0.00	3/8 A325	6

HORIZONTAL MEMBERS

Sect	Top Elev	Member	Force (kips)	Load Case	Len (ft)	Bracing %			Fy (ksi)	Mem Cap (kips)	Num Bolts	Num Holes	Shear Cap (kips)	Bear Cap (kips)	Use %	Controls
						X	Y	Z								
1	20								0.00	0	0					
2	40								0.00	0	0					
3	60								0.00	0	0					
4	80								0.00	0	0					
5	100								0.00	0	0					
6	120								0.00	0	0					
7	140								0.00	0	0					
8	160								0.00	0	0					
9	180								0.00	0	0					
10	190	SAE - 2X2X0.1875	-0.28	0.9D + 1.6W Normal Wind	5.41	100	100	100	164.65	36.00	5.92	1	1	12.43	9.79	5 Member Z

DIAGONAL MEMBERS

Sect	Top Elev	Member	Force (kips)	Load Case	Len (ft)	Bracing %			Fy (ksi)	Mem Cap (kips)	Num Bolts	Num Holes	Shear Cap (kips)	Bear Cap (kips)	Use %	Controls
						X	Y	Z								
1	20	SAE - 4X4X0.25	-14.9	1.2D + 1.6W 90° Wind	23.18	49	49	49	171.44	36.00	14.91	1	1	24.35	17.4	101 Member Z
2	40	SAE - 4X4X0.25	-15.2	1.2D + 1.6W 90° Wind	21.46	48	48	48	155.49	36.00	18.13	1	1	24.35	17.4	88 Bolt Bear
3	60	SAE - 4X4X0.25	-14.5	1.2D + 1.6W 90° Wind	19.76	48	48	48	143.17	36.00	21.38	1	1	24.35	17.4	84 Bolt Bear
4	80	SAE - 3.5X3.5X0.25	-13.6	1.2D + 1.6W 90° Wind	18.08	48	48	48	150.02	36.00	16.96	1	1	24.35	17.4	80 Member Z
5	100	SAE - 3.5X3.5X0.25	-12.8	1.2D + 1.6W 90° Wind	16.42	48	48	48	136.26	36.00	20.56	1	1	24.35	17.4	74 Bolt Bear
6	120	SAE - 3X3X0.1875	-11.3	1.2D + 1.6W 90° Wind	14.19	48	48	48	137.10	36.00	13.10	1	1	24.35	13.0	87 Bolt Bear

Force/Stress Compression Summary

Structure: MA12227-A-SBA	Code: TIA-222-G	10/26/2023
Site Name: Truro	Exposure: B	
Height: 190.00 (ft)	Crest Height: 0.00	
Base Elev: 0.000 (ft)	Site Class: D - Stiff Soil	
Gh: 0.85	Topography: 1	Struct Class: III



Page: 14

DIAGONAL MEMBERS

Sect	Top Elev	Member	Force (kips)	Load Case	Len (ft)	Bracing %			Fy (ksi)	Mem Cap (kips)	Num Bolts	Num Holes	Shear Cap		Bear Cap %	Use Controls	
						X	Y	Z					(kips)	(kips)			
7	140	SAE - 2.5X2.5X0.25	-10.6	1.2D + 1.6W 90° Wind	12.52	47	47	47	143.77	36.00	13.01	1	1	24.35	17.4	82	Member Z
8	160	SAE - 2.5X2.5X0.1875	-9.05	1.2D + 1.6W 90° Wind	10.89	48	48	48	126.74	36.00	12.55	1	1	24.35	13.0	72	Member Z
9	180	SAE - 2.5X2.5X0.1875	-7.68	1.2D + 1.6W 90° Wind	9.33	47	47	47	109.72	36.00	15.51	1	1	24.35	13.0	59	Bolt Bear
10	190	SAE - 2X2X0.1875	-2.43	0.9D + 1.6W 90° Wind	7.00	46	46	46	103.53	36.00	13.08	1	1	12.43	9.79	25	Bolt Bear

Force/Stress Tension Summary

Structure: MA12227-A-SBA	Code: TIA-222-G	10/26/2023
Site Name: Truro	Exposure: B	
Height: 190.00 (ft)	Crest Height: 0.00	
Base Elev: 0.000 (ft)	Site Class: D - Stiff Soil	
Gh: 0.85	Topography: 1	Struct Class: III
		Page: 15



LEG MEMBERS

Sect	Top Elev	Member	Force (kips)	Load Case	Fy (ksi)	Mem Cap (kips)	Leg Use %	Controls
1	20	SOL - 5 1/4" SOLID	446.93	0.9D + 1.6W 60° Wind	50	974.16	45.9	Member
2	40	SOL - 5 1/4" SOLID	402.36	0.9D + 1.6W 60° Wind	50	974.16	41.3	Member
3	60	SOL - 5" SOLID	355.79	0.9D + 1.6W 60° Wind	50	883.58	40.3	Member
4	80	SOL - 5" SOLID	307.53	0.9D + 1.6W 60° Wind	50	883.58	34.8	Member
5	100	SOL - 4 3/4" SOLID	257.42	0.9D + 1.6W 60° Wind	50	797.45	32.3	Member
6	120	SOL - 4 1/4" SOLID	207.55	0.9D + 1.6W 60° Wind	50	638.37	32.5	Member
7	140	SOL - 4" SOLID	152.90	0.9D + 1.6W 60° Wind	50	565.47	27.0	Member
8	160	SOL - 3 3/4" SOLID	95.30	0.9D + 1.6W 60° Wind	50	497.03	19.2	Member
9	180	SOL - 3 1/2" SOLID	38.96	0.9D + 1.6W 60° Wind	50	432.95	9.0	Member
10	190	SOL - 3" SOLID	5.42	0.9D + 1.6W 60° Wind	50	318.11	1.7	Member

Splices

Sect	Top Elev	Top Splice					Bottom Splice						
		Load Case	Force (kips)	Cap (kips)	Use %	Bolt Type	Num Bolts	Load Case	Force (kips)	Cap (kips)	Use %	Bolt Type	Num Bolts
1	20	0.9D + 1.6W 60° Wind	408.68	0.00	0.0		0	0.9D + 1.6W 60° Wind	455.3	0.00			
2	40	0.9D + 1.6W 60° Wind	362.28	0.00	0.0		0	0.9D + 1.6W 60° Wind	408.6	663.98	61.6	1 1/2 A325	6
3	60	0.9D + 1.6W 60° Wind	314.39	0.00	0.0		0	0.9D + 1.6W 60° Wind	362.2	663.98	54.6	1 1/2 A325	6
4	80	0.9D + 1.6W 60° Wind	264.77	0.00	0.0		0	0.9D + 1.6W 60° Wind	314.3	663.98	47.3	1 1/2 A325	6
5	100	0.9D + 1.6W 60° Wind	212.87	0.00	0.0		0	0.9D + 1.6W 60° Wind	264.7	663.98	39.9	1 1/2 A325	6
6	120	0.9D + 1.6W 60° Wind	159.08	0.00	0.0		0	0.9D + 1.6W 60° Wind	212.8	545.68	39.0	1 3/8 A325	6
7	140	0.9D + 1.6W 60° Wind	100.95	0.00	0.0		0	0.9D + 1.6W 60° Wind	159.0	545.68	29.2	1 3/8 A325	6
8	160	0.9D + 1.6W 60° Wind	45.57	0.00	0.0		0	0.9D + 1.6W 60° Wind	100.9	545.68	18.5	1 3/8 A325	6
9	180	0.9D + 1.6W 60° Wind	6.87	0.00	0.0		0	0.9D + 1.6W 60° Wind	45.57	545.68	8.4	1 3/8 A325	6
10	190		0.00	0.00	0.0		0	0.9D + 1.6W 60° Wind	6.87	545.68	1.3	1 3/8 A325	6

HORIZONTAL MEMBERS

Sect	Top Elev	Member	Force (kips)	Load Case	Fy (ksi)	Mem Cap (kips)	Num Bolts	Num Holes	Shear Cap (kips)	Bear Cap (kips)	B.S. Cap (kips)	Use %	Controls
1	20	-			36	0.00	0	0					
2	40	-			36	0.00	0	0					
3	60	-			36	0.00	0	0					
4	80	-			36	0.00	0	0					
5	100	-			36	0.00	0	0					
6	120	-			36	0.00	0	0					
7	140	-			36	0.00	0	0					
8	160	-			36	0.00	0	0					
9	180	-			36	0.00	0	0					
10	190	SAE - 2X2X0.1875	0.30	1.2D + 1.6W 60° Wind	36	18.58	1	1	12.43	9.79	7.50	4.0	Blck Shear

DIAGONAL MEMBERS

Sect	Top Elev	Member	Force (kips)	Load Case	Fy (ksi)	Mem Cap (kips)	Num Bolts	Num Holes	Shear Cap (kips)	Bear Cap (kips)	B.S. Cap (kips)	Use %	Controls
1	20	SAE - 4X4X0.25	15.40	0.9D + 1.6W 90° Wind	36	55.14	1	1	24.35	17.40	16.95	90.8	Blck Shear
2	40	SAE - 4X4X0.25	15.12	0.9D + 1.6W 90° Wind	36	55.14	1	1	24.35	17.40	16.95	89.2	Blck Shear
3	60	SAE - 4X4X0.25	14.37	1.2D + 1.6W 90° Wind	36	55.14	1	1	24.35	17.40	16.95	84.8	Blck Shear
4	80	SAE - 3.5X3.5X0.25	13.50	1.2D + 1.6W 90° Wind	36	46.98	1	1	24.35	17.40	16.95	79.7	Blck Shear
5	100	SAE - 3.5X3.5X0.25	12.70	1.2D + 1.6W 90° Wind	36	46.98	1	1	24.35	17.40	16.95	74.9	Blck Shear
6	120	SAE - 3X3X0.1875	11.18	1.2D + 1.6W 90° Wind	36	29.44	1	1	24.35	13.05	10.67	104.8	Blck Shear
7	140	SAE - 2.5X2.5X0.25	10.56	1.2D + 1.6W 90° Wind	36	30.67	1	1	24.35	17.40	12.87	82.0	Blck Shear

Force/Stress Tension Summary

Structure: MA12227-A-SBA	Code: TIA-222-G	10/26/2023
Site Name: Truro	Exposure: B	
Height: 190.00 (ft)	Crest Height: 0.00	
Base Elev: 0.000 (ft)	Site Class: D - Stiff Soil	
Gh: 0.85	Topography: 1	Struct Class: III



Page: 16

DIAGONAL MEMBERS

Sect	Top Elev	Member	Force		Fy (ksi)	Mem Cap (kips)	Num Bolts	Num Holes	Shear Cap (kips)	Bear Cap (kips)	B.S. Cap (kips)	Use %	Controls
			(kips)	Load Case									
8	160	SAE - 2.5X2.5X0.1875	8.98	1.2D + 1.6W 90° Wind	36	23.31	1	1	24.35	13.05	9.65	93.1	Blck Shear
9	180	SAE - 2.5X2.5X0.1875	7.60	1.2D + 1.6W 90° Wind	36	23.31	1	1	24.35	13.05	9.65	78.7	Blck Shear
10	190	SAE - 2X2X0.1875	2.47	1.2D + 1.6W 90° Wind	36	18.58	1	1	12.43	9.79	7.50	32.9	Blck Shear

Seismic Section Forces

Structure: MA12227-A-SBA	Code: TIA-222-G	10/26/2023
Site Name: Truro	Exposure: B	
Height: 190.00 (ft)	Crest Height: 0.00	
Base Elev: 0.000 (ft)	Site Class: D - Stiff Soil	
Gh: 0.85	Topography: 1	Struct Class: III

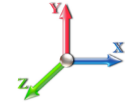

Page: 17

Load Case: 1.2D + 1.0E

Dead Load Factor	1.20	Sds 0.175	Ss 0.1640	Fa 1.6000	Ke 0.0000
Seismic Load Factor	1.00	Sd1 0.091	S1 0.0570	Fv 2.4000	Kg 0.0000
Seismic Importance Factor	1.50	SA 0.152	R 3.0000	Vs 6.4200	f1 1.6730

Sect #	Elev (ft)	Wz (lb)	Lateral			Fsz (lb)
			a	b	c	
1	10.00	8357.3	0.01	0.05	0.03	40.62
2	30.00	8153.8	0.05	0.07	0.04	85.04
3	50.00	7540.8	0.13	0.07	0.03	125.09
4	70.00	7089.3	0.26	0.05	0.02	175.44
5	90.00	6526.1	0.42	0.01	0.01	217.16
6	110.00	5353.4	0.63	-0.06	0.02	221.27
7	130.00	6963.3	0.88	-0.12	0.08	366.26
8	150.00	5778.8	1.18	-0.02	0.24	445.72
9	170.00	10223.	1.51	0.53	0.56	1312.33
10	185.00	4115.2	1.79	1.50	0.96	785.73

Load Case: 0.9D + 1.0E

Dead Load Factor	0.90	Sds 0.175	Ss 0.1640	Fa 1.6000	Ke 0.0000
Seismic Load Factor	1.00	Sd1 0.091	S1 0.0570	Fv 2.4000	Kg 0.0000
Seismic Importance Factor	1.50	SA 0.152	R 3.0000	Vs 6.4200	f1 1.6730

Sect #	Elev (ft)	Wz (lb)	Lateral			Fsz (lb)
			a	b	c	
1	10.00	8357.3	0.01	0.05	0.03	40.62
2	30.00	8153.8	0.05	0.07	0.04	85.04
3	50.00	7540.8	0.13	0.07	0.03	125.09
4	70.00	7089.3	0.26	0.05	0.02	175.44
5	90.00	6526.1	0.42	0.01	0.01	217.16
6	110.00	5353.4	0.63	-0.06	0.02	221.27
7	130.00	6963.3	0.88	-0.12	0.08	366.26
8	150.00	5778.8	1.18	-0.02	0.24	445.72
9	170.00	10223.	1.51	0.53	0.56	1312.33
10	185.00	4115.2	1.79	1.50	0.96	785.73

Support Forces Summary

Structure: MA12227-A-SBA
Site Name: Truro
Height: 190.00 (ft)
Base Elev: 0.000 (ft)
Gh: 0.85

Topography: 1

Code: TIA-222-G
Exposure: B
Crest Height: 0.00
Site Class: D - Stiff Soil
Struct Class: III

10/26/2023

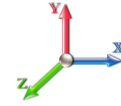

Page: 18

Load Case	Node	FX (kips)	FY (kips)	FZ (kips)	(-) = Uplift (+) = Down
1.2D + 1.6W Normal Wind	1	0.00	528.19	-51.05	
	1a	16.85	-222.03	-18.15	
	1b	-16.85	-222.03	-18.15	
1.2D + 1.6W 60° Wind	1	-6.35	265.25	-24.78	
	1a	-24.64	265.25	6.90	
	1b	-39.62	-446.38	-22.88	
1.2D + 1.6W 90° Wind	1	-7.69	28.04	-1.47	
	1a	-38.56	444.47	18.03	
	1b	-36.73	-388.39	-16.56	
0.9D + 1.6W Normal Wind	1	0.00	520.70	-50.67	
	1a	17.17	-228.80	-18.34	
	1b	-17.17	-228.80	-18.34	
0.9D + 1.6W 60° Wind	1	-6.36	258.01	-24.40	
	1a	-24.31	258.01	6.70	
	1b	-39.94	-452.93	-23.06	
0.9D + 1.6W 90° Wind	1	-7.70	21.03	-1.09	
	1a	-38.23	437.06	17.83	
	1b	-37.05	-395.00	-16.74	
1.2D + 1.0Di + 1.0Wi Normal Wind	1	0.00	168.29	-9.43	
	1a	3.95	20.03	-3.85	
	1b	-3.95	20.03	-3.85	
1.2D + 1.0Di + 1.0Wi 60° Wind	1	-1.30	117.82	-4.38	
	1a	-4.44	117.81	1.06	
	1b	-8.68	-27.29	-5.01	
1.2D + 1.0Di + 1.0Wi 90° Wind	1	-1.53	69.45	0.41	
	1a	-7.25	153.68	3.32	
	1b	-8.00	-14.79	-3.73	
1.2D + 1.0E	1	0.00	56.55	5.27	
	1a	7.42	13.79	-4.50	
	1b	-7.42	13.79	-4.50	
0.9D + 1.0E	1	0.00	49.51	5.66	
	1a	7.76	6.79	-4.70	
	1b	-7.76	6.79	-4.70	
1.0D + 1.0W Normal Wind	1	0.00	97.08	-8.67	
	1a	1.59	-13.49	-2.14	
	1b	-1.59	-13.49	-2.14	
1.0D + 1.0W 60° Wind	1	-0.97	58.32	-4.73	
	1a	-4.58	58.32	1.53	
	1b	-4.92	-46.54	-2.84	
1.0D + 1.0W 90° Wind	1	-1.15	23.37	-1.26	
	1a	-6.67	84.73	3.19	
	1b	-4.49	-38.00	-1.93	

Max Reactions

Leg

Overturing

Max Uplift: -452.93 (kips)

Max Down: 528.19 (kips)

Max Shear: 51.05 (kips)

Moment: 9745.70 (ft-kips)

Total Down: 84.12 (kips)

Total Shear: 87.35 (kips)

Analysis Summary

Structure: MA12227-A-SBA	Code: TIA-222-G	10/26/2023
Site Name: Truro	Exposure: B	
Height: 190.00 (ft)	Crest Height: 0.00	
Base Elev: 0.000 (ft)	Site Class: D - Stiff Soil	
Gh: 0.85	Topography: 1	Struct Class: III
		Page: 20



Max Reactions

	Leg	Overturning
Max Uplift:	-452.93 (kips)	Moment: 9745.70 (ft-kips)
Max Down:	528.19 (kips)	Total Down: 84.12 (kips)
Max Shear:	51.05 (kips)	Total Shear: 87.35 (kips)

Anchor Bolts

Bolt Size (in.): 2.00	Number Bolts: 8
Yield Strength (Ksi): 50.00	Tensile Strength (Ksi): 65.00
Detail Type: D	Length: 1.00

Interaction Ratio: 0.61

Max Usages

Max Leg: 70.1% (1.2D + 1.6W Normal Wind - Sect 1)
 Max Diag: 104.8% (1.2D + 1.6W 90° Wind - Sect 6)
 Max Horiz: 4.8% (0.9D + 1.6W Normal Wind - Sect 10)

Max Deflection, Twist and Sway

Load Case	Elevation (ft)	Deflection (ft)	Twist (deg)	Sway (deg)
0.9D + 1.0E - Normal To Face	140.00	0.0437	0.0016	0.0355
	155.00	0.0534	0.0018	0.0394
	165.00	0.0604	0.0018	0.0411
	175.00	0.0674	0.0018	0.0411
	186.67	0.0756	0.0018	0.0402
	190.00	0.0761	0.0000	0.0399
0.9D + 1.6W 115 mph Wind at 60° From Face	140.00	0.6489	-0.0217	0.4841
	155.00	0.7812	-0.0229	0.5191
	165.00	0.8728	-0.0234	0.5241
	175.00	0.9641	-0.0236	0.5258
	186.67	1.0697	-0.0230	0.5138
	190.00	1.0989	-0.0220	0.4947
0.9D + 1.6W 115 mph Wind at 90° From Face	140.00	0.6565	-0.0253	0.4894
	155.00	0.7903	-0.0267	0.5223
	165.00	0.8829	-0.0272	0.5286
	175.00	0.9750	-0.0275	0.5331
	186.67	1.0816	-0.0268	0.5188
	190.00	1.1109	-0.0255	0.4946
0.9D + 1.6W 115 mph Wind at Normal To Face	140.00	0.6795	0.0225	0.5032
	155.00	0.8172	0.0237	0.5392
	165.00	0.9122	0.0242	0.5440
	175.00	1.0071	0.0245	0.5460
	186.67	1.1168	0.0238	0.5336
	190.00	1.1470	0.0000	0.5287

1.0D + 1.0W 60 mph Wind at 60° From Face	140.00	0.0954	-0.0032	0.0709
	155.00	0.1149	-0.0034	0.0760
	165.00	0.1283	-0.0034	0.0770
	175.00	0.1417	-0.0035	0.0769
	186.67	0.1572	-0.0034	0.0754
	190.00	0.1615	-0.0032	0.0726

1.0D + 1.0W 60 mph Wind at 90° From Face	140.00	0.0966	-0.0037	0.0718
	155.00	0.1162	-0.0039	0.0767
	165.00	0.1298	-0.0040	0.0776
	175.00	0.1433	-0.0040	0.0782
	186.67	0.1590	-0.0039	0.0761
	190.00	0.1633	-0.0037	0.0725

1.0D + 1.0W 60 mph Wind at Normal To Face	140.00	0.1000	0.0033	0.0739
	155.00	0.1202	0.0035	0.0792
	165.00	0.1342	0.0036	0.0797
	175.00	0.1481	0.0036	0.0803
	186.67	0.1642	0.0035	0.0783
	190.00	0.1686	0.0000	0.0777

1.2D + 1.0Di + 1.0Wi 50 mph Wind at 60° From Face	140.00	0.1324	-0.0043	0.0966
	155.00	0.1586	-0.0046	0.1024
	165.00	0.1766	-0.0046	0.1040
	175.00	0.1946	-0.0047	0.1039
	186.67	0.2154	-0.0046	0.1018
	190.00	0.2204	-0.0044	0.0985

1.2D + 1.0Di + 1.0Wi 50 mph Wind at 90° From Face	140.00	0.1329	-0.0050	0.0970
	155.00	0.1592	-0.0053	0.1032
	165.00	0.1773	-0.0054	0.1043
	175.00	0.1953	-0.0054	0.1046
	186.67	0.2162	-0.0053	0.1021
	190.00	0.2216	-0.0051	0.0978

1.2D + 1.0Di + 1.0Wi 50 mph Wind at Normal From Face	140.00	0.1344	0.0044	0.0982
	155.00	0.1611	0.0046	0.1048
	165.00	0.1795	0.0047	0.1052
	175.00	0.1978	0.0047	0.1060
	186.67	0.2189	0.0046	0.1033
	190.00	0.2239	0.0000	0.1028

1.2D + 1.0E - Normal To Face	140.00	0.0437	0.0016	0.0356
	155.00	0.0535	0.0018	0.0395
	165.00	0.0604	0.0019	0.0412
	175.00	0.0675	0.0019	0.0412
	186.67	0.0757	0.0018	0.0403
	190.00	0.0762	0.0000	0.0399

1.2D + 1.6W 115 mph Wind at 60° From Face	140.00	0.6496	-0.0217	0.4847
	155.00	0.7822	-0.0229	0.5198
	165.00	0.8739	-0.0234	0.5249
	175.00	0.9653	-0.0236	0.5265
	186.67	1.0711	-0.0230	0.5146
	190.00	1.1004	-0.0220	0.4954

1.2D + 1.6W 115 mph Wind at 90° From Face	140.00	0.6572	-0.0253	0.4902
	155.00	0.7913	-0.0267	0.5231
	165.00	0.8840	-0.0273	0.5294
	175.00	0.9763	-0.0276	0.5339
	186.67	1.0830	-0.0268	0.5196
	190.00	1.1124	-0.0256	0.4954

1.2D + 1.6W 115 mph Wind at Normal To Face	140.00	0.6804	0.0226	0.5040
	155.00	0.8182	0.0237	0.5401
	165.00	0.9134	0.0242	0.5447
	175.00	1.0083	0.0245	0.5468
	186.67	1.1182	0.0238	0.5344
	190.00	1.1485	0.0000	0.5295



Mat Foundation Design for Self Supporting Tower

Date
10/26/2023

Customer Name:	SBA Communications Corp	TIA Standard:	TIA-222-G
Site Name:		Structure Height (Ft.):	190
Site Nmber:	MA12227-A-SBA	Engineer Name:	S. Shrestha
Engr. Number:	143003	Engineer Login ID:	

Foundation Info Obtained from:

Mapping Operation

Analysis or Design?

Analysis

Number of Tower Legs:

3 Legs

Base Reactions (Factored):

(1). Individual Leg:

Axial Load (Kips):	528.2	Uplift Force (Kips):	453.0
Shear Force (Kips):	51.1		

(2). Tower Base:

Total Vertical Load (Kips):	84.1	Total Shear Force (Kips):	87.4
Moment (Kips-ft):	9745.7		

Foundation Geometries:

Leg distance (Center-to-Center ft.):	22.5	Mods required -Yes/No ?:	No
Diameter of Pier (ft.):	Round 14.0	Pier Height A. G. (ft.):	0.00
Tower center to mat center (ft):	0	Depth of Base BG (ft.):	4.5
Length of Pad (ft.):	38	Width of Pad (ft.):	38
Thickness of Pad (ft):	4.50		

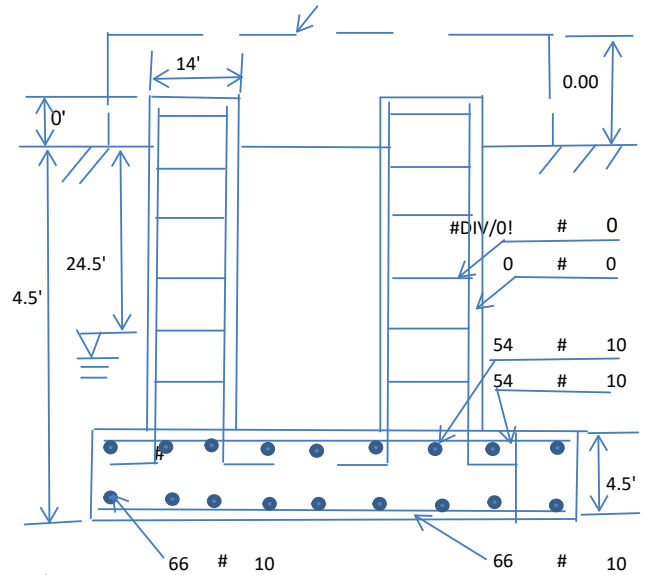

Material Properties and Rebar Info:

Concrete Strength (psi):	3000	Steel Elastic Modulus:	29000	ksi
Vertical bar yield (ksi):		Tie steel yield (ksi):		
Vertical Rebar Size #:		Tie / Stirrup Size #:		
Qty. of Vertical Rebars:		Tie Spacing (in):		
Pad Rebar Yield (Ksi):	60	Pad Steel Rebar Size (#):	10	
Concrete Cover (in.):	3	Unit Weight of Concrete:	150.0	pcf
Rebar at the bottom of the concrete pad:				
Qty. of Rebar in Pad (L):	66	Qty. of Rebar in Pad (W):	66	
Rebar at the top of the concrete pad:				
Qty. of Rebar in Pad (L):	54	Qty. of Rebar in Pad (W):	54	

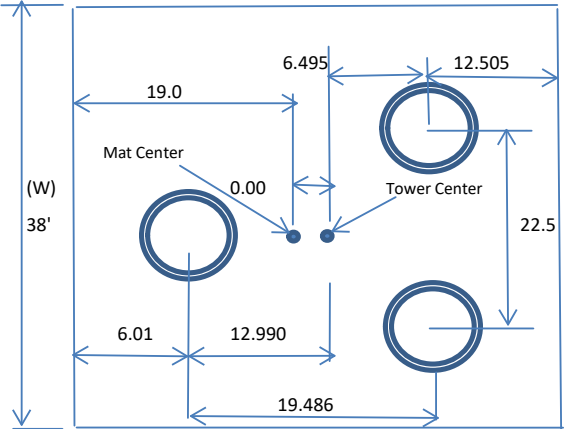

Soil Design Parameters:

Soil Unit Weight (pcf):	125.0	Soil Buoyant Weight:	50.0	Pcf
Water Table B.G.S. (ft):	24.5	Unit Weight of Water:	62.4	pcf
Ultimate Bearing Pressure (psf):	4000	Consider ties in concrete shear strength:	No	
Consider Soil Lateral Resistance ?	No			

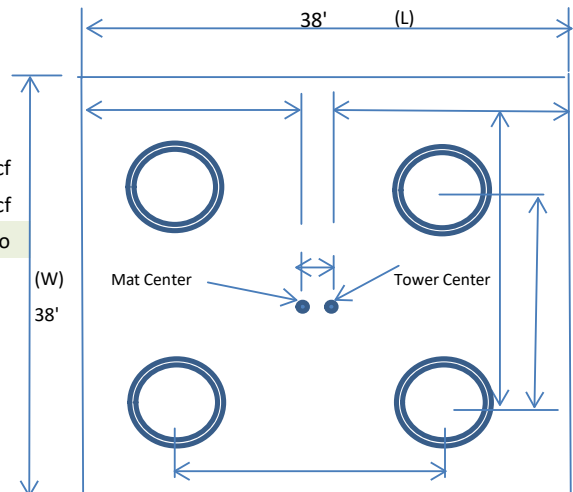

Angle from Top of Pad:	0	Angle from Bottm of Pad:	0
Final Length of pad (ft)	38.0	Final width of pad (ft):	38.0

Angle from Bottm of Pad: 0

Allowable overstress %: 5.00%
 Apply 1.35 for e/w per G/H: 1.35

TES Engr. Number: 143003

Page 2/2 Date: 10/26/2023

Foundation Analysis and Design:	Uplift Strength Reduction Factor:	0.75	Compression Strength Reduction Factor:	0.75
	Total Dry Soil Volume (cu. Ft.):	0.00	Total Dry Soil Weight (Kips):	0.00
	Total Buoyant Soil Volume (cu. Ft.):	0.00	Total Buoyant Soil Weight (Kips):	0.00
	Total Effective Soil Weight (Kips):	0.00	Weight from the Concrete Block at Top (K):	0.00
	Total Dry Concrete Volume (cu. Ft.):	6500.31	Total Dry Concrete Weight (Kips):	975.05
	Total Buoyant Concrete Volume (cu. Ft.):	0.00	Total Buoyant Concrete Weight (Kips):	0.00
	Total Effective Concrete Weight (Kips):	975.05	Total Vertical Load on Base (Kips):	1059.17

Check Soil Capacities:

Calculated Maxium Net Soil Pressure under the base (psf):	2041.78	<	Allowable Factored Soil Bearing (psf):	3000	0.68	OK!
Allowable Foundation Overturning Resistance (kips-ft.):	18271.6	>	Design Factored Momont (kips-ft):	10139	0.55	OK!
Factor of Safety Against Overturning (O. R. Moment/Design Moment):	1.80					OK!

Check the capacities of Reinforceing Concrete:

Strength reduction factor (Flexure and axial tension):	0.90	Strength reduction factor (Shear):	0.75
Strength reduction factor (Axial compression):	0.65	Wind Load Factor on Concrete Design:	1.00

(2).Concrete Pad:

One-Way Design Shear Capacity (L or W Direction, Kips):	1887.3	>	One-Way Factored Shear (L/W-Dir Kips)	275.9	0.15	OK!
One-Way Design Shear Capacity (Diagonal Dir., Kips):	947.5	>	One-Way Factored Shear (Dia. Dir, Kips)	235.8	0.25	OK!
Lower Steel Pad Reinforcement Ratio (L or W-Direct.):	0.0036		Lower Steel Reinf. Ratio (Dia. Dir.):	0.0040		
Lower Steel Pad Moment Capacity (L or W-Dir. Kips-ft):	18185.3	>	Moment at Bottom (L-Direct. K-Ft):	1451.9	0.08	OK!
Lower Steel Pad Moment Capacity (Dia. Direction,K-ft):	14992.1	>	Moment at Bottom (Dia. Dir. K-Ft):	1378.8	0.09	OK!
Upper Steel Pad Reinforcement Ratio (L or W -Direction):	0.0030		Upper Steel Reinf. Ratio (Dia. Dir.):	0.0033		
Upper Steel Pad Moment Capacity (L or W-Dir., Kips-ft):	15000.2	>	Moment at the top (L-Dir Kips-Ft):	754.4	0.05	OK!
Upper Steel Pad Moment Capacity (Dia. Direction, K-ft):	12376.1	>	Moment at the top (Dia. Dir., K-Ft):	500.4	0.04	OK!
Punching Failure Capacity (Kips):	4230.0	>	Punch. Failure Factored Shear (K):	528.2	0.12	OK!

Rebar Info Assl

Concrete Strength (Psi):	3000	Vertical bar yield (ksi)	60	Pad Rebar Yield (Ksi):	60
Vertical Rebar Size #:	0	Vertical Rebar Area (sq. in./each):	#N/A	Min. Qty. of Vertical Rebars:	#N/A
Pad Steel Rebar Size (#):	10	Vertical Rebar Area (sq. in./each):	1.27		
Min. Qty. of Rebars in L-Direction:	#DIV/0!	Min. Qty. of Rebars in W-Direction:	#DIV/0!		

Reinforce Concrete Pad by enlarging the size of pier (Yes/No): No



November 7, 2023

Catherine Ware
SBA Network Services, LLC.
101 Interchange Plaza, Suite 103
Cranbury, NJ 08512
(917) 868-8365

B+T Group
1717 S. Boulder, Suite 300
Tulsa, OK 74119
(918) 587-4630
btwo@btgrp.com

Subject: **Appurtenance Mount Analysis Report**

Carrier Designation: **Dish Wireless Co-Locate**

Site Number: BOBOS00593A
Site Name: N/A

SBA Network Services Designation: **Site Number:** MA12227-A
Site Name: Truro
Application Number: 163468, v1

Engineering Firm Designation: **B+T Group Project Number:** 149562.005.01.0001

Site Data: **5 Town Dump Road, Truro, MA, 02666, Barnstable County**
Latitude 41.98578°, Longitude -70.04133°
Self-Support Tower
(3) 8 ft. Sector Mount

Dear Catherine Ware,

B+T Group is pleased to submit this “**Appurtenance Mount Analysis Report**” to determine the structural integrity of the antenna mount on the above-mentioned structure.

The purpose of the analysis is to determine the acceptability of the mount’s stress level. Based on our analysis we have determined the stress level for the mount under the following load case to be:

Proposed Equipment	Sufficient Capacity
Note: See Table 1 for the final loading configuration	(Passing at 49.3%)

The analysis has been performed in accordance with the ANSI/TIA-222-G standard and 2015 IBC as amended by the Massachusetts State Building Code, Ninth Edition, based upon an ultimate 3-second gust wind speed of 149 mph converted to a nominal 3-second gust wind speed of 115 mph per section 1609.3.1 as required for use in the ANSI/TIA-222-G Standard per Exception #5 of Section 1609.1.1. Exposure Category B and Risk Category III were used in this analysis.

All the equipment proposed in this report shall be installed in accordance with the drawings for the determined available structural capacity to be effective.

We at B+T Group appreciate the opportunity of providing our continuing professional services to you and SBA Network Services, LLC. If you have any questions or need further assistance on this or any other projects, please give us a call.

Mount structural analysis prepared by: Joseph Variamparampil

Respectfully submitted by: B&T Engineering, Inc.

Peter D. Smith, P.E.

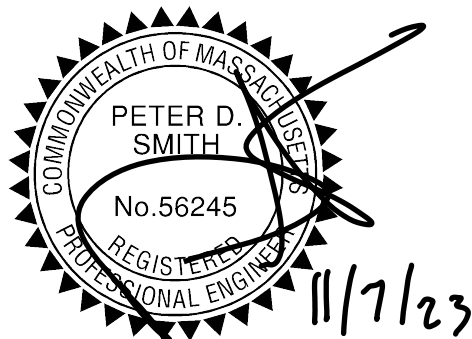

TABLE OF CONTENTS

1) INTRODUCTION

2) ANALYSIS CRITERIA

Table 1 - Proposed Equipment Information

Table 2 - Documents Provided

3) ANALYSIS PROCEDURE

3.1) Analysis Method

3.2) Assumptions

4) ANALYSIS RESULTS

Table 3 – Mount Component Stresses vs. Capacity

5) RECOMMENDATIONS

6) APPENDIX A

RISA-3D Output

7) APPENDIX B

Additional Calculations

1) INTRODUCTION

The appurtenance mount consists of Commscope sector mount Part# MTC3975083 at 155 ft., attached to self-support tower at 5 Town Dump Road, Truro, MA, 02666, Barnstable County. The proposed antenna loading information was obtained from SBA Network Services, LLC. All information provided to B+T Group was assumed accurate and complete.

2) ANALYSIS CRITERIA

The structural analysis was performed for this mount in accordance with the ANSI/TIA-222-G-2-2005 Structural Standard for Antenna Supporting Structures and Antennas – Addendum 2 using a 3-second gust wind speed of 115 mph with no ice and 50 mph with 0.75 inch escalated ice thickness Exposure category B & Topographic Category 1 and Risk Category III were used in the analysis. In addition, the sector mount has been analyzed for various live loading conditions consisting of a 250-lb man live load applied individually at the midpoint and cantilevered ends of horizontal members as well as a 500-pound man live load applied individually at mount pipe locations using a 3-second gust of 30mph. The mount was analyzed under 30° increments in the wind direction. The analyzed loading is detailed in Table 1.

Table 1 – Proposed Equipment Information

Loading	RAD Center Elev. (ft.)	Position	Qty.	Description	Note
Proposed	155	1	3	JMA Wireless MX08FRO665-21	1
			3	Fujitsu TA08025-B605	2
			3	Fujitsu TA08025-B604	
		-	1	Raycap RDIDC-9181-PF-48	3

Note:

- 1) Proposed Antenna to be installed on the Proposed Mount Pipe.
- 2) Proposed Equipment to be installed directly behind the Antenna
- 3) Proposed Equipment to be installed on Mount.

Table 2 - Documents Provided

Documents	Remarks	Reference	Source
SBA Application	Proposed Loading	Date: 06/28/2021	SBA Network Services, LLC.
RFDS		Date: 05/27/2021	
Mount Analysis	B+T Group	Date: 07/23/2021	On File

3) ANALYSIS PROCEDURE

3.1) Analysis Method

RISA-3D (Version 21.0.1), a commercially available analysis software package, was used to create a three-dimensional model of the mount and calculate member stresses and deflections for various loading cases. Selected output from the analysis is included in Appendix A.

Manufacturer's drawings were used to create the model.

3.2) Assumptions

1. The mount was built in accordance with the manufacturer's specifications.
2. The mount has been maintained in accordance with the manufacturer's specifications and is free of damage.
3. The configuration of antennas and other appurtenances are as specified in Table 1.
4. All mount components have been assumed to be in sufficient condition to carry their full design capacity for the analysis.

5. Mount areas and weights are determined from field measurements, standard material properties, and/or manufacturer product data.
6. Serviceability with respect to antenna twist, tilt, roll or lateral translation is not checked and is left to the carrier or tower owner to ensure conformance.
7. All prior structural modifications, if any are assumed to be correctly installed and fully effective.
8. All member connections are assumed to have been designed to meet or exceed the load carrying capacity of the connected member unless otherwise specified in this report.
9. The following material grades were assumed (Unless Noted Otherwise):
 - a) Connection Bolts : ASTM A325
 - b) Steel Pipe : ASTM A53 (GR. 35)
 - c) HSS (Round) : ASTM 500 (GR. B-42)
 - d) HSS (Rectangular) : ASTM 500 (GR. B-46)
 - e) Channel : ASTM A36 (GR. 36)
 - f) Steel Solid Rod : ASTM A36 (GR. 36)
 - g) Steel Plate : ASTM A36 (GR. 36)
 - h) Steel Angle : ASTM A36 (GR. 36)
 - i) UNISTRUT : ASTM A570 (GR. 33)

This analysis may be affected if any assumptions are not valid or have been made in error. B+T Group should be notified to determine the effect on the structural integrity of the antenna mounting system.

4) ANALYSIS RESULTS

Table 3 – Mount Component Stresses vs. Capacity

Notes	Component	Elevation (ft.)	% Capacity	Pass / Fail
-	Face Horizontals	155	26.1	Pass
-	Support Arms	155	30.7	Pass
-	Diagonals	155	49.3	Pass
-	Connection Plates	155	25.6	Pass
-	Verticals	155	47.7	Pass
-	Tiebacks	155	29.8	Pass
-	Mount Pipes	155	29.2	Pass

5) RECOMMENDATIONS

The Commscope sector mount Part# MTC3975083 has sufficient capacity to carry the proposed loads and is in compliance with the ANSI/TIA-222-G standard for the proposed loading. (Refer to the RISA output for the specific members).

APPENDIX A

(RISA-3D Output)

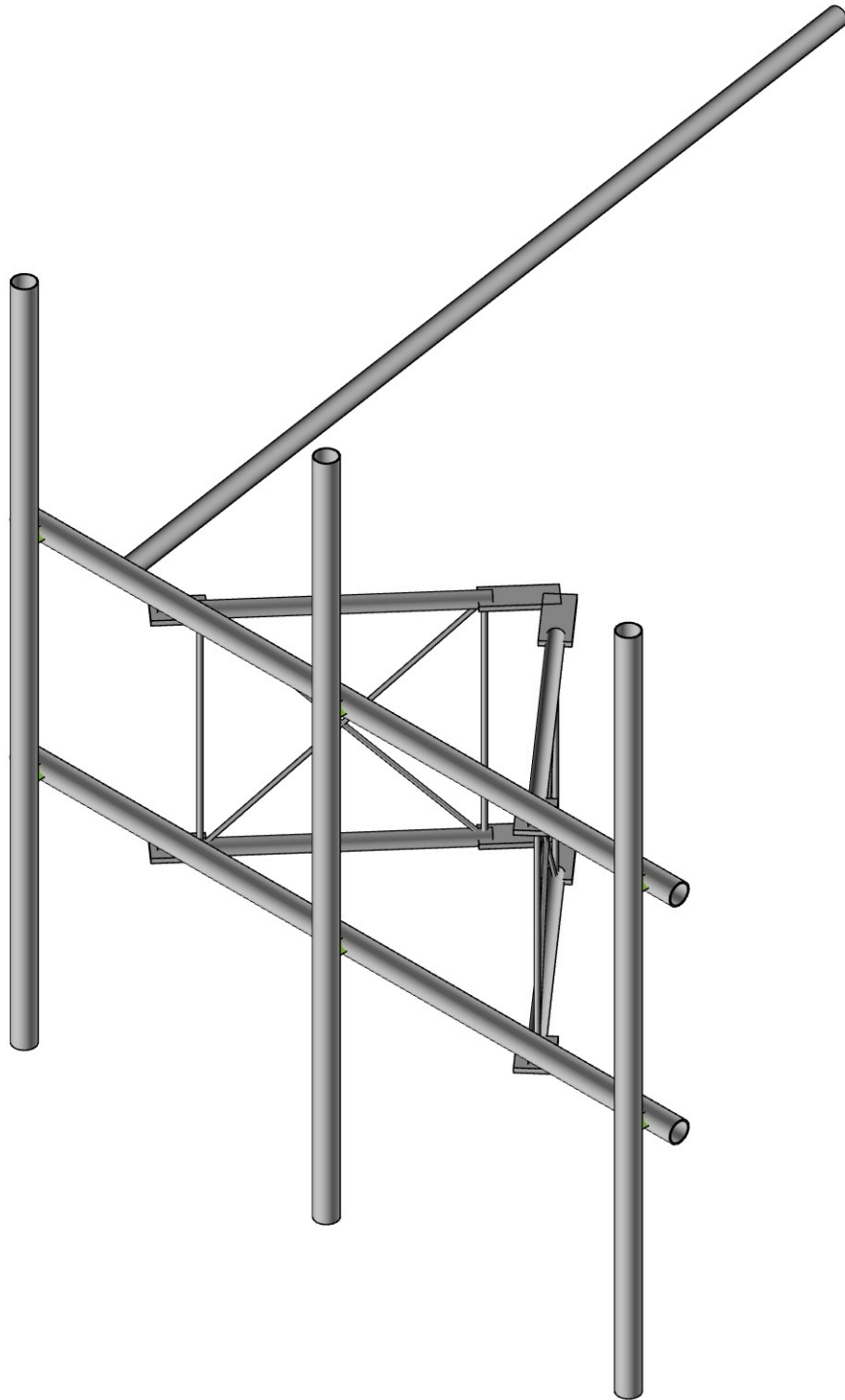
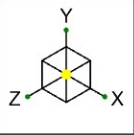

Envelope Only Solution



B+T Group

MSP

149562.005.01.0001

MA12227-A - Truro

SK-1

Oct 27, 2023 at 05:13 PM

149562_005_01_0001_Truro...

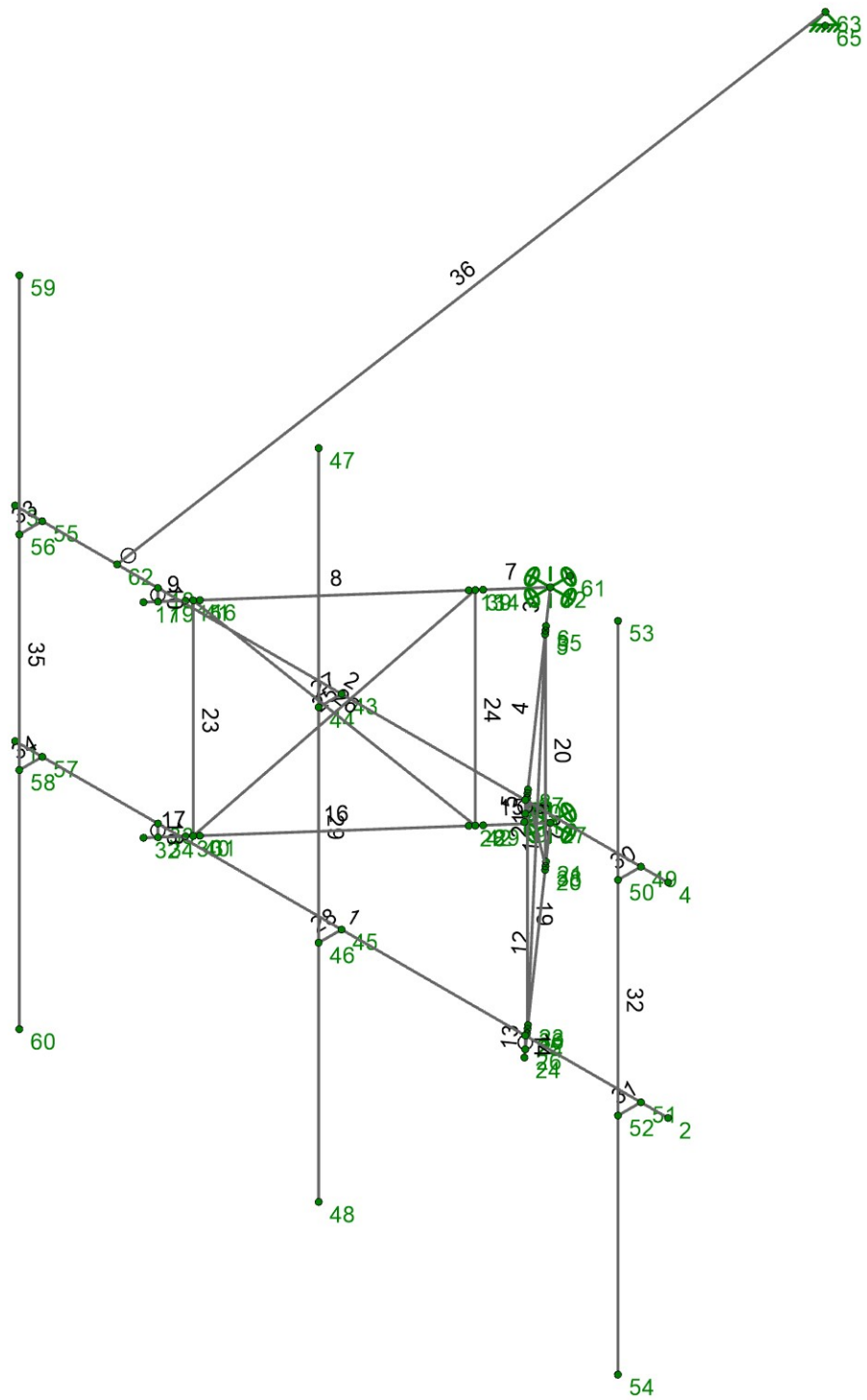
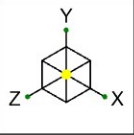

Envelope Only Solution



B+T Group

MSP

149562.005.01.0001

MA12227-A - Truro

SK-2

Oct 27, 2023 at 05:13 PM

149562_005_01_0001_Truro...

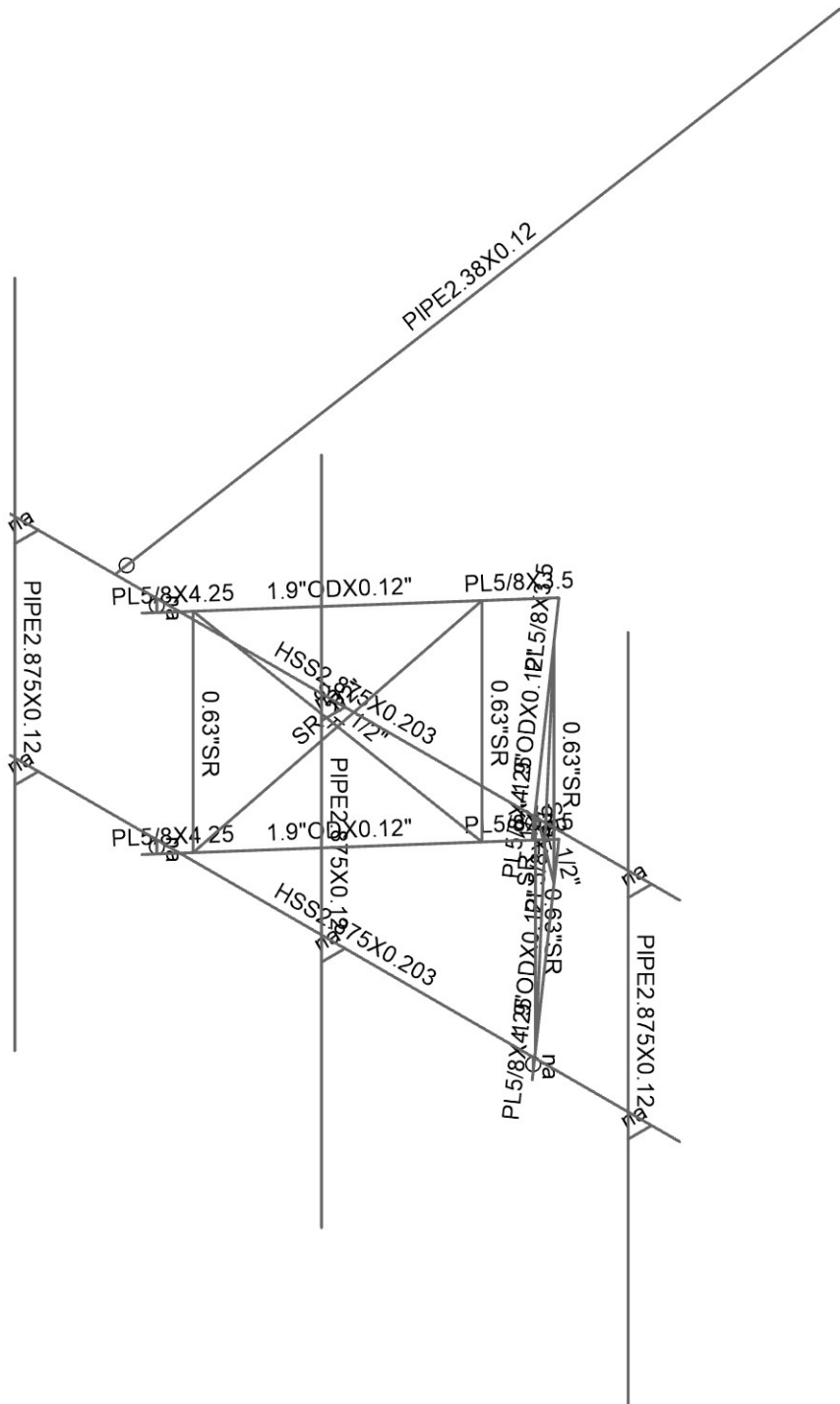
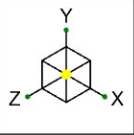

Envelope Only Solution



B+T Group

MSP

149562.005.01.0001

MA12227-A - Truro

SK-3

Oct 27, 2023 at 05:14 PM

149562_005_01_0001_Truro...

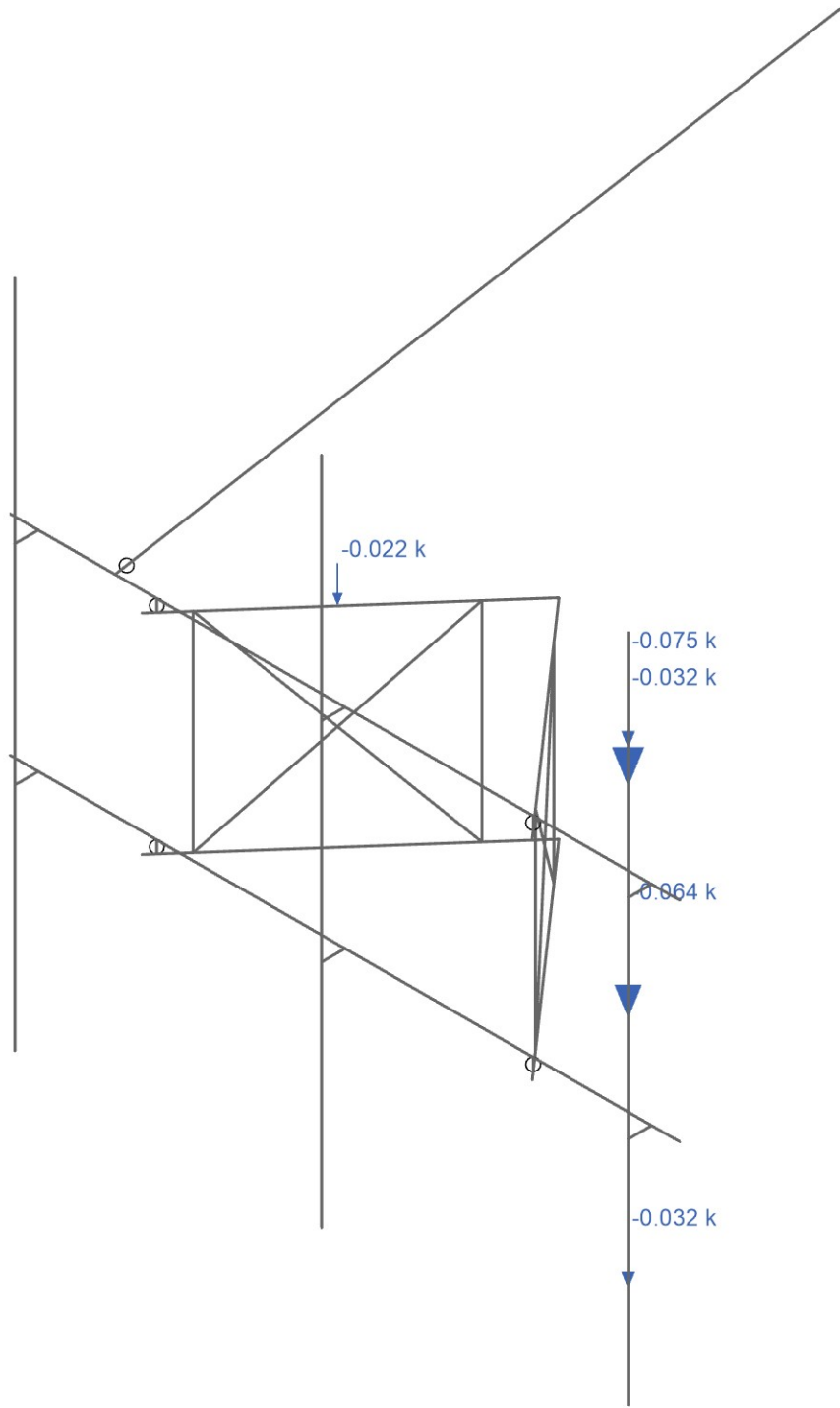
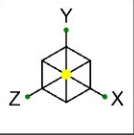

Loads: BLC 1, Dead
Envelope Only Solution

 IRISA A NEMETSCHKE COMPANY	B+T Group
	MSP
	149562.005.01.0001

MA12227-A - Truro
SK-4
Oct 27, 2023 at 05:14 PM
149562_005_01_0001_Truro...

SK-4
Oct 27, 2023 at 05:14 PM
149562_005_01_0001_Truro...

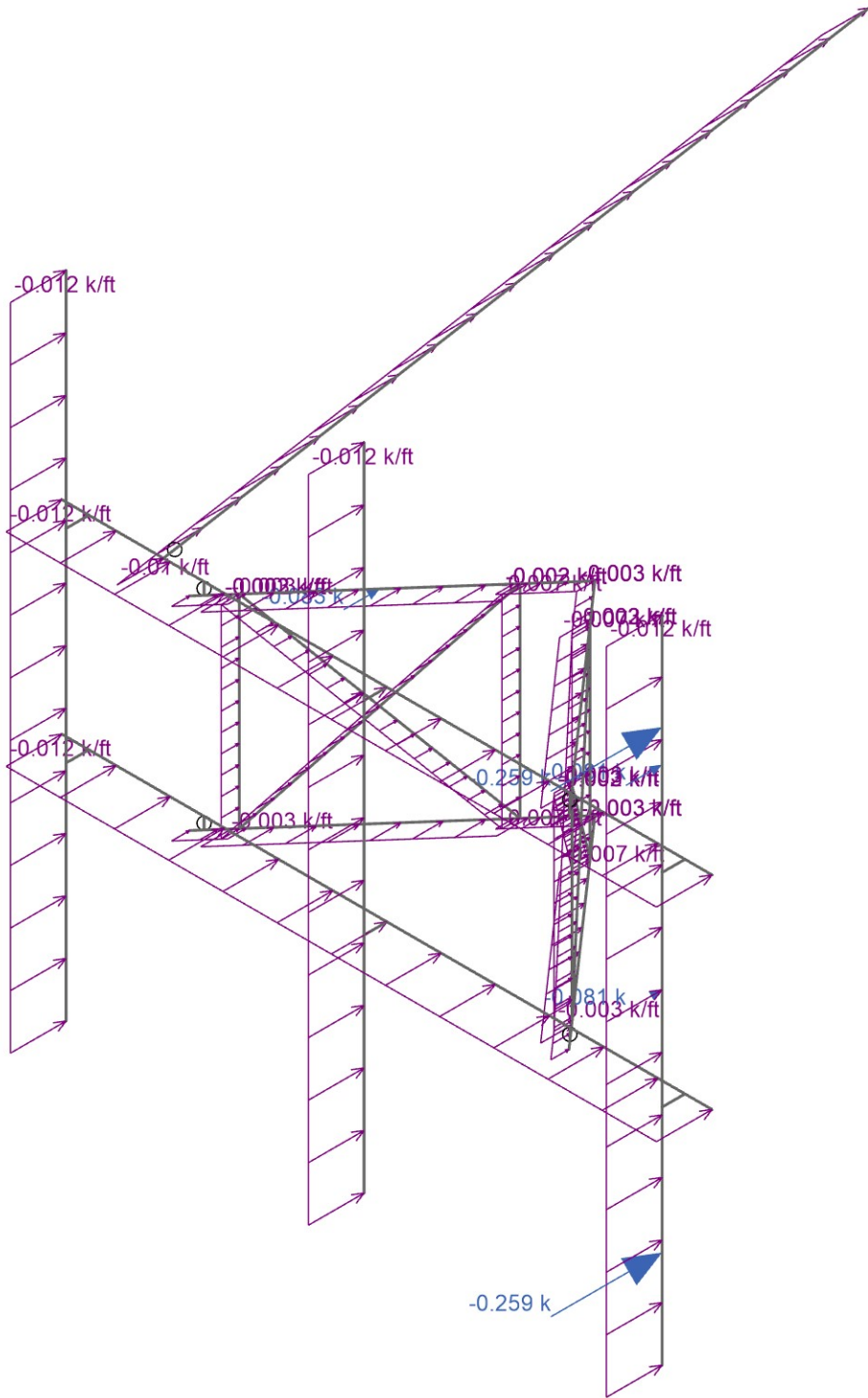
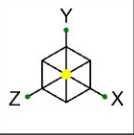

Loads: BLC 2, 0 Wind - No Ice
Envelope Only Solution



B+T Group

MSP

149562.005.01.0001

MA12227-A - Truro

SK-5

Oct 27, 2023 at 05:14 PM

149562_005_01_0001_Truro...

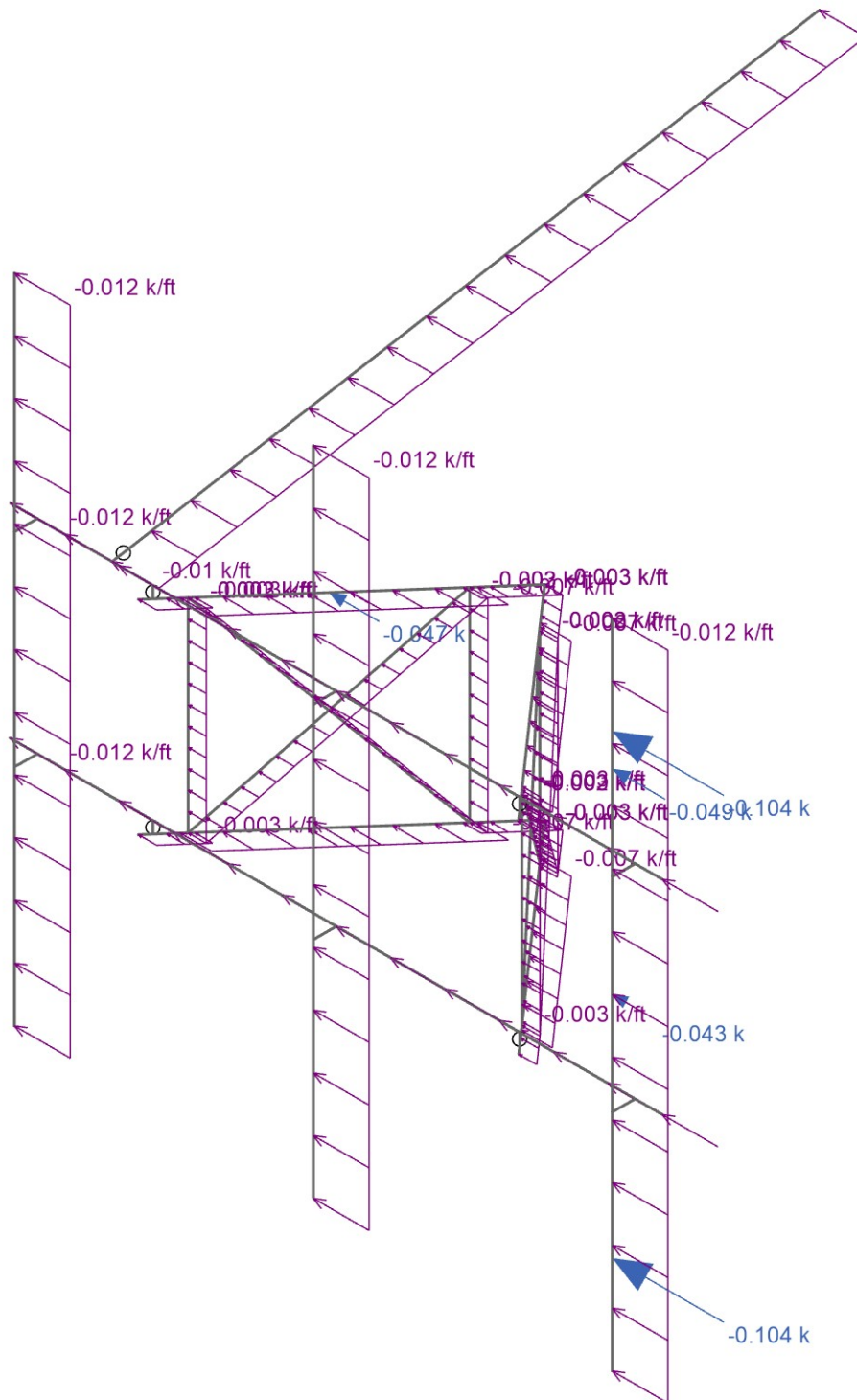
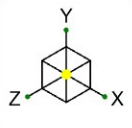

Loads: BLC 3, 90 Wind - No Ice
Envelope Only Solution

	B+T Group	MA12227-A - Truro	SK-6
	MSP		Oct 27, 2023 at 05:14 PM
	149562.005.01.0001		149562_005_01_0001_Truro...

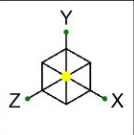

Code Check (Env)	
Black	No Calc
Red	> 1.0
Magenta	.90-1.0
Green	.75-.90
Cyan	.50-.75
Blue	0-.50

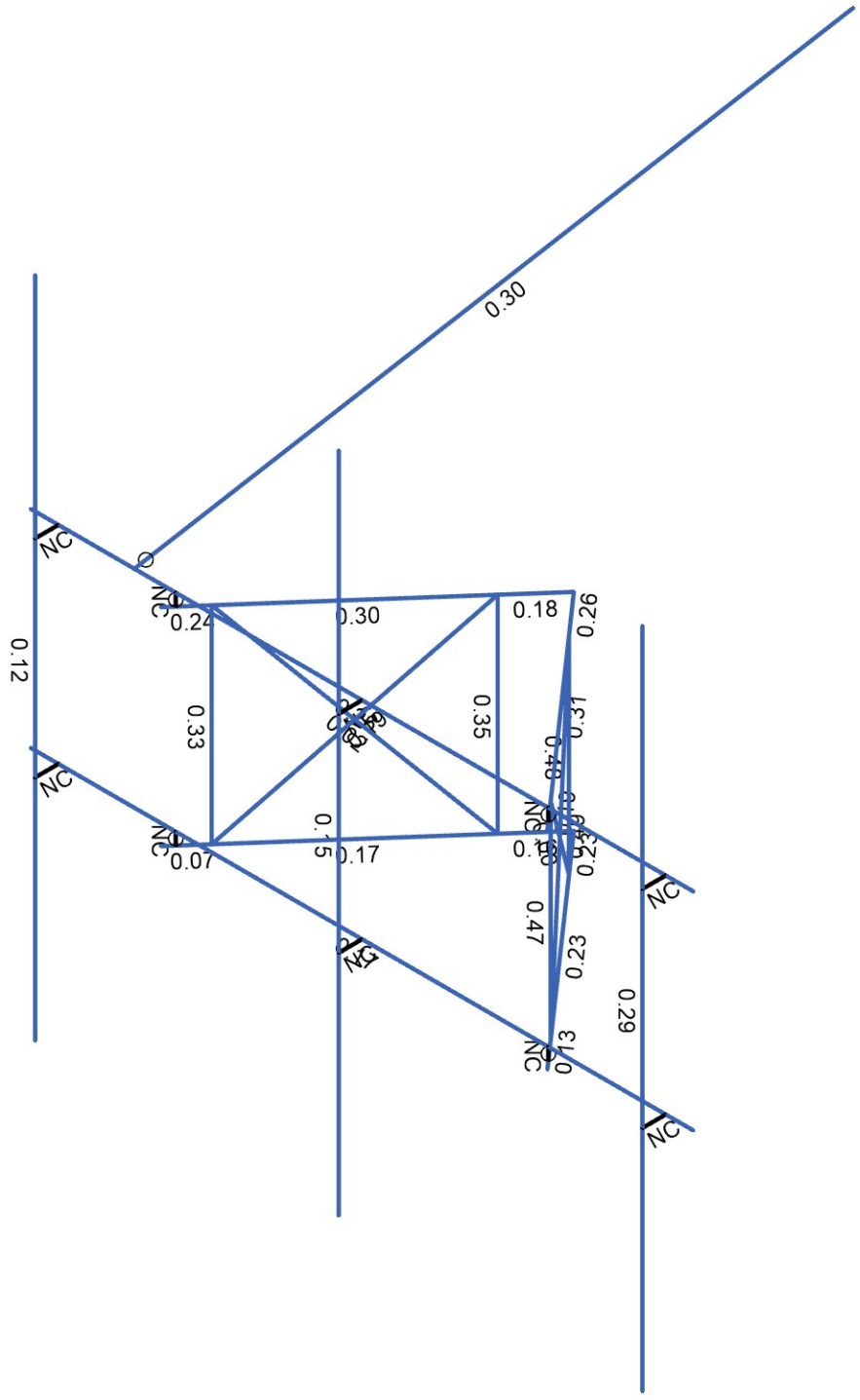

Member Code Checks Displayed (Enveloped)
Envelope Only Solution

	B+T Group
	MSP
	149562.005.01.0001

MA12227-A - Truro

SK-7
Oct 27, 2023 at 05:14 PM
149562_005_01_0001_Truro...



Shear Check (Env)

- No Calc
- > 1.0
- .90-1.0
- .75-.90
- .50-.75
- 0-.50

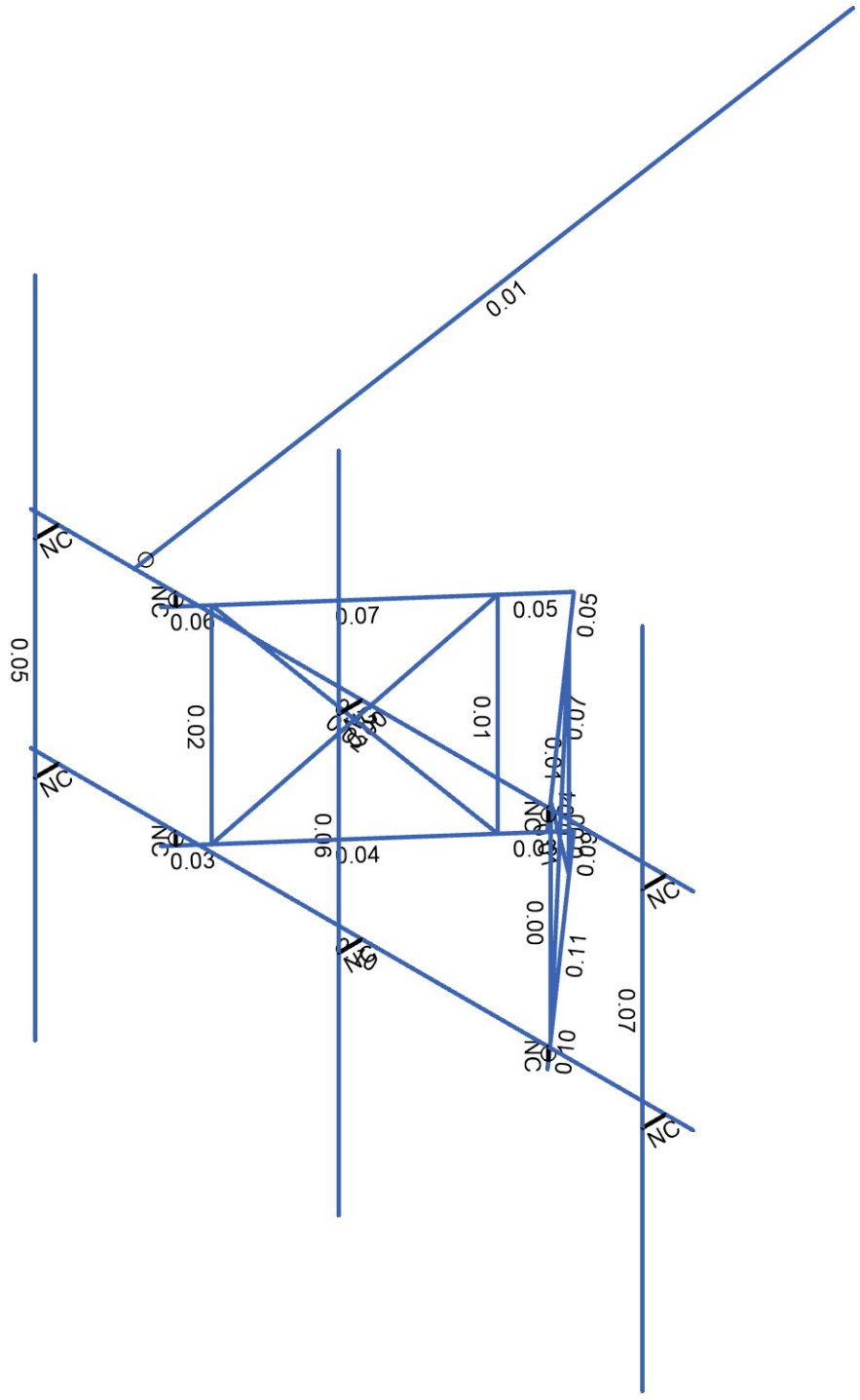

Member Shear Checks Displayed (Enveloped)
Envelope Only Solution

	B+T Group
	MSP
	149562.005.01.0001

MA12227-A - Truro

SK-8
Oct 27, 2023 at 05:14 PM
149562_005_01_0001_Truro...



Company : B+T Group
 Designer : MSP
 Job Number : 149562.005.01.0001
 Model Name : MA12227-A - Truro

10/27/2023
 5:15:23 PM
 Checked By : _____

Node Coordinates

	Label	X [ft]	Y [ft]	Z [ft]	Detach From Diaphragm
1	1	-4	-2.354167	2.796875	
2	2	4	-2.354167	2.796875	
3	3	-4	0.145833	2.796875	
4	4	4	0.145833	2.796875	
5	5	0.467947	0	0.771833	
6	6	0.385368	0	0.677994	
7	7	2.091999	0	2.61733	
8	8	2.00942	0	2.523491	
9	9	2.332579	0	2.890714	
10	10	2.25	0.145833	2.796875	
11	11	2.25	0	2.796875	
12	12	0	0	0.24008	
13	13	-0.467947	0	0.771833	
14	14	-0.385368	0	0.677994	
15	15	-2.091999	0	2.61733	
16	16	-2.00942	0	2.523491	
17	17	-2.332579	0	2.890714	
18	18	-2.25	0.145833	2.796875	
19	19	-2.25	0	2.796875	
20	20	0.467947	-2.5	0.771833	
21	21	0.385368	-2.5	0.677994	
22	22	2.091999	-2.5	2.61733	
23	23	2.00942	-2.5	2.523491	
24	24	2.332579	-2.5	2.890714	
25	25	2.25	-2.354167	2.796875	
26	26	2.25	-2.5	2.796875	
27	27	0	-2.5	0.24008	
28	28	-0.467947	-2.5	0.771833	
29	29	-0.385368	-2.5	0.677994	
30	30	-2.091999	-2.5	2.61733	
31	31	-2.00942	-2.5	2.523491	
32	32	-2.332579	-2.5	2.890714	
33	33	-2.25	-2.354167	2.796875	
34	34	-2.25	-2.5	2.796875	
35	35	0.430236	0	0.72898	
36	36	2.047131	-2.5	2.566344	
37	37	2.047131	0	2.566344	
38	38	0.430236	-2.5	0.72898	
39	39	-0.430236	0	0.72898	
40	40	-2.047131	-2.5	2.566344	
41	41	-2.047131	0	2.566344	
42	42	-0.430236	-2.5	0.72898	
43	43	0	0.145833	2.796875	
44	44	0	0.145833	3.078125	
45	45	0	-2.354167	2.796875	
46	46	0	-2.354167	3.078125	
47	47	0	2.895833	3.078125	
48	48	0	-5.104167	3.078125	
49	49	3.666667	0.145833	2.796875	
50	50	3.666667	0.145833	3.078125	
51	51	3.666667	-2.354167	2.796875	
52	52	3.666667	-2.354167	3.078125	
53	53	3.666667	2.895833	3.078125	
54	54	3.666667	-5.104167	3.078125	
55	55	-3.666667	0.145833	2.796875	

Node Coordinates (Continued)

	Label	X [ft]	Y [ft]	Z [ft]	Detach From Diaphragm
56	56	-3.666667	0.145833	3.078125	
57	57	-3.666667	-2.354167	2.796875	
58	58	-3.666667	-2.354167	3.078125	
59	59	-3.666667	2.895833	3.078125	
60	60	-3.666667	-5.104167	3.078125	
61	61	0	0	0	
62	62	-2.75	0.145833	2.796875	
63	63	-4.275	0.145833	-7.404517	
64	64	4.275	0	-7.404517	
65	65	-4.275	0	-7.404517	

Node Boundary Conditions

	Node Label	X [k/in]	Y [k/in]	Z [k/in]	X Rot [k-ft/rad]	Z Rot [k-ft/rad]
1	12	Reaction	Reaction	Reaction	Reaction	Reaction
2	27	Reaction	Reaction	Reaction	Reaction	Reaction
3	63	Reaction	Reaction	Reaction		

Hot Rolled Steel Properties

	Label	E [ksi]	G [ksi]	Nu	Therm. Coeff. [1e°F ⁻¹]	Density [k/ft ³]	Yield [ksi]	Ry	Fu [ksi]	Rt
1	A992	29000	11154	0.3	0.65	0.49	50	1.1	65	1.1
2	A36 Gr.36	29000	11154	0.3	0.65	0.49	36	1.5	58	1.2
3	A572 Gr.50	29000	11154	0.3	0.65	0.49	50	1.1	65	1.1
4	A500 Gr.B RND	29000	11154	0.3	0.65	0.527	42	1.4	58	1.3
5	A500 Gr.B Rect	29000	11154	0.3	0.65	0.527	46	1.4	58	1.3
6	A53 Gr.B	29000	11154	0.3	0.65	0.49	35	1.6	60	1.2
7	A1085	29000	11154	0.3	0.65	0.49	50	1.4	65	1.3
8	A529 Gr.50	29000	11154	0.3	0.65	0.49	50	1.1	65	1.1
9	A500 Gr.42	29000	11154	0.3	0.65	0.49	42	1.4	58	1.3
10	A500 Gr.46	29000	11154	0.3	0.65	0.49	46	1.4	58	1.3
11	A500 Gr.C	29000	11154	0.3	0.65	0.49	46	1.4	62	1.3

Hot Rolled Steel Section Sets

	Label	Shape	Type	Design List	Material	Design Rule	Area [in ²]	Iyy [in ⁴]	Izz [in ⁴]	J [in ⁴]
1	MF-H1	HSS2.875X0.203	Beam	HSS Pipe	A500 Gr.C	Typical	1.59	1.45	1.45	2.89
2	MF-SA1	1.9"ODX0.12"	Beam	Pipe	A500 Gr.B RND	Typical	0.671	0.267	0.267	0.534
3	MF-D1	SR 1/2"	VBrace	BAR	A529 Gr.50	Typical	0.196	0.003	0.003	0.006
4	MF-CP1	PL5/8X3.5	Beam	RECT	A572 Gr.50	Typical	2.205	0.073	2.251	0.259
5	MF-V1	0.63"SR	Column	BAR	A529 Gr.50	Typical	0.312	0.008	0.008	0.015
6	MF-CP2	PL5/8X4.25	Beam	RECT	A572 Gr.50	Typical	2.656	0.086	3.998	0.314
7	Tieback	PIPE2.38X0.12	Beam	Pipe	A500 Gr.C	Typical	0.852	0.545	0.545	1.091
8	MF-P1	PIPE2.875X0.12	Column	Pipe	A500 Gr.C	Typical	1.039	0.987	0.987	1.975

Member Primary Data

	Label	I Node	J Node	Rotate(deg)	Section/Shape	Type	Design List	Material	Design Rule
1	1	1	2		MF-H1	Beam	HSS Pipe	A500 Gr.C	Typical
2	2	3	4		MF-H1	Beam	HSS Pipe	A500 Gr.C	Typical
3	3	12	5	90	MF-CP1	Beam	RECT	A572 Gr.50	Typical
4	4	6	7		MF-SA1	Beam	Pipe	A500 Gr.B RND	Typical
5	5	8	9	90	MF-CP2	Beam	RECT	A572 Gr.50	Typical
6	6	10	11	90	RIGID	None	None	RIGID	Typical

Member Primary Data (Continued)

	Label	I Node	J Node	Rotate(deg)	Section/Shape	Type	Design List	Material	Design Rule
7	7	12	13	90	MF-CP1	Beam	RECT	A572 Gr.50	Typical
8	8	14	15		MF- SA1	Beam	Pipe	A500 Gr.B RND	Typical
9	9	16	17	90	MF-CP2	Beam	RECT	A572 Gr.50	Typical
10	10	18	19	90	RIGID	None	None	RIGID	Typical
11	11	27	20	90	MF-CP1	Beam	RECT	A572 Gr.50	Typical
12	12	21	22		MF- SA1	Beam	Pipe	A500 Gr.B RND	Typical
13	13	23	24	90	MF-CP2	Beam	RECT	A572 Gr.50	Typical
14	14	25	26	90	RIGID	None	None	RIGID	Typical
15	15	27	28	90	MF-CP1	Beam	RECT	A572 Gr.50	Typical
16	16	29	30		MF- SA1	Beam	Pipe	A500 Gr.B RND	Typical
17	17	31	32	90	MF-CP2	Beam	RECT	A572 Gr.50	Typical
18	18	33	34	90	RIGID	None	None	RIGID	Typical
19	19	37	36		MF-V1	Column	BAR	A529 Gr.50	Typical
20	20	35	38		MF-V1	Column	BAR	A529 Gr.50	Typical
21	21	35	36		MF-D1	VBrace	BAR	A529 Gr.50	Typical
22	22	37	38		MF-D1	VBrace	BAR	A529 Gr.50	Typical
23	23	41	40		MF-V1	Column	BAR	A529 Gr.50	Typical
24	24	39	42		MF-V1	Column	BAR	A529 Gr.50	Typical
25	25	39	40		MF-D1	VBrace	BAR	A529 Gr.50	Typical
26	26	41	42		MF-D1	VBrace	BAR	A529 Gr.50	Typical
27	27	43	44	90	RIGID	None	None	RIGID	Typical
28	28	45	46	90	RIGID	None	None	RIGID	Typical
29	29	47	48		MF-P1	Column	Pipe	A500 Gr.C	Typical
30	30	49	50	90	RIGID	None	None	RIGID	Typical
31	31	51	52	90	RIGID	None	None	RIGID	Typical
32	32	53	54		MF-P1	Column	Pipe	A500 Gr.C	Typical
33	33	55	56	90	RIGID	None	None	RIGID	Typical
34	34	57	58	90	RIGID	None	None	RIGID	Typical
35	35	59	60		MF-P1	Column	Pipe	A500 Gr.C	Typical
36	36	62	63		Tieback	Beam	Pipe	A500 Gr.C	Typical

Member Advanced Data

	Label	I Release	T/C Only	Physical	Deflection Ratio Options	Seismic DR
1	1			Yes	N/A	None
2	2			Yes	N/A	None
3	3			Yes	N/A	None
4	4			Yes	N/A	None
5	5			Yes	N/A	None
6	6	OOOOXO		Yes	** NA **	None
7	7			Yes	N/A	None
8	8			Yes	N/A	None
9	9			Yes	N/A	None
10	10	OOOOXO		Yes	** NA **	None
11	11			Yes	N/A	None
12	12			Yes	N/A	None
13	13			Yes	N/A	None
14	14	OOOOXO		Yes	** NA **	None
15	15			Yes	N/A	None
16	16			Yes	N/A	None
17	17			Yes	N/A	None
18	18	OOOOXO		Yes	** NA **	None
19	19			Yes	** NA **	None
20	20			Yes	** NA **	None
21	21			Yes	** NA **	None
22	22		Euler Buckling	Yes	** NA **	None

Member Advanced Data (Continued)

	Label	I Release	T/C Only	Physical	Deflection Ratio Options	Seismic DR
23	23			Yes	** NA **	None
24	24			Yes	** NA **	None
25	25			Yes	** NA **	None
26	26		Euler Buckling	Yes	** NA **	None
27	27			Yes	** NA **	None
28	28			Yes	** NA **	None
29	29			Yes	** NA **	None
30	30			Yes	** NA **	None
31	31			Yes	** NA **	None
32	32			Yes	** NA **	None
33	33			Yes	** NA **	None
34	34			Yes	** NA **	None
35	35			Yes	** NA **	None
36	36	BenPIN		Yes	Default	None

Hot Rolled Steel Design Parameters

	Label	Shape	Length [ft]	Lcomp top [ft]	Channel Conn.	a [ft]	Function
1	1	MF-H1	8	Lbyy	N/A	N/A	Lateral
2	2	MF-H1	8	Lbyy	N/A	N/A	Lateral
3	3	MF-CP1	0.708	Lbyy	N/A	N/A	Lateral
4	4	MF- SA1	2.583	Lbyy	N/A	N/A	Lateral
5	5	MF-CP2	0.489	Lbyy	N/A	N/A	Lateral
6	7	MF-CP1	0.708	Lbyy	N/A	N/A	Lateral
7	8	MF- SA1	2.583	Lbyy	N/A	N/A	Lateral
8	9	MF-CP2	0.489	Lbyy	N/A	N/A	Lateral
9	11	MF-CP1	0.708	Lbyy	N/A	N/A	Lateral
10	12	MF- SA1	2.583	Lbyy	N/A	N/A	Lateral
11	13	MF-CP2	0.489	Lbyy	N/A	N/A	Lateral
12	15	MF-CP1	0.708	Lbyy	N/A	N/A	Lateral
13	16	MF- SA1	2.583	Lbyy	N/A	N/A	Lateral
14	17	MF-CP2	0.489	Lbyy	N/A	N/A	Lateral
15	19	MF-V1	2.5	Lbyy	N/A	N/A	Lateral
16	20	MF-V1	2.5	Lbyy	N/A	N/A	Lateral
17	21	MF-D1	3.499	Lbyy	N/A	N/A	Lateral
18	22	MF-D1	3.499	Lbyy	N/A	N/A	Lateral
19	23	MF-V1	2.5	Lbyy	N/A	N/A	Lateral
20	24	MF-V1	2.5	Lbyy	N/A	N/A	Lateral
21	25	MF-D1	3.499	Lbyy	N/A	N/A	Lateral
22	26	MF-D1	3.499	Lbyy	N/A	N/A	Lateral
23	29	MF-P1	8	Lbyy	N/A	N/A	Lateral
24	32	MF-P1	8	Lbyy	N/A	N/A	Lateral
25	35	MF-P1	8	Lbyy	N/A	N/A	Lateral
26	36	Tieback	10.315	Lbyy	N/A	N/A	Lateral

Member Point Loads (BLC 1 : Dead)

	Member Label	Direction	Magnitude [k, k-ft]	Location [(ft, %)]
1	32	Y	-0.032	%15
2	32	Y	-0.032	%85
3	32	Y	-0.075	%20
4	32	Y	-0.064	%50
5	32	Y	0	0
6	8	Y	-0.022	%50
7	8	Y	0	0

Member Point Loads (BLC 1 : Dead) (Continued)

	Member Label	Direction	Magnitude [k, k-ft]	Location [(ft, %)]
8	8	Y	0	0
9	8	Y	0	0
10	8	Y	0	0

Member Point Loads (BLC 2 : 0 Wind - No Ice)

	Member Label	Direction	Magnitude [k, k-ft]	Location [(ft, %)]
1	32	Z	-0.259	%15
2	32	Z	-0.259	%85
3	32	Z	-0.081	%20
4	32	Z	-0.081	%50
5	32	Z	0	0
6	8	Z	-0.083	%50
7	8	Z	0	0
8	8	Z	0	0
9	8	Z	0	0
10	8	Z	0	0

Member Point Loads (BLC 3 : 90 Wind - No Ice)

	Member Label	Direction	Magnitude [k, k-ft]	Location [(ft, %)]
1	32	X	-0.103	%15
2	32	X	-0.103	%85
3	32	X	-0.049	%20
4	32	X	-0.043	%50
5	32	X	0	0
6	8	X	-0.047	%50
7	8	X	0	0
8	8	X	0	0
9	8	X	0	0
10	8	X	0	0

Member Point Loads (BLC 4 : 0 Wind - Ice)

	Member Label	Direction	Magnitude [k, k-ft]	Location [(ft, %)]
1	32	Z	-0.055	%15
2	32	Z	-0.055	%85
3	32	Z	-0.022	%20
4	32	Z	-0.022	%50
5	32	Z	0	0
6	8	Z	-0.022	%50
7	8	Z	0	0
8	8	Z	0	0
9	8	Z	0	0
10	8	Z	0	0

Member Point Loads (BLC 5 : 90 Wind - Ice)

	Member Label	Direction	Magnitude [k, k-ft]	Location [(ft, %)]
1	32	X	-0.028	%15
2	32	X	-0.028	%85
3	32	X	-0.015	%20
4	32	X	-0.014	%50
5	32	X	0	0

Member Point Loads (BLC 5 : 90 Wind - Ice) (Continued)

	Member Label	Direction	Magnitude [k, k-ft]	Location [(ft, %)]
6	8	X	-0.015	%50
7	8	X	0	0
8	8	X	0	0
9	8	X	0	0
10	8	X	0	0

Member Point Loads (BLC 6 : 0 Wind - Service)

	Member Label	Direction	Magnitude [k, k-ft]	Location [(ft, %)]
1	32	Z	-0.018	%15
2	32	Z	-0.018	%85
3	32	Z	-0.005	%20
4	32	Z	-0.005	%50
5	32	Z	0	0
6	8	Z	-0.006	%50
7	8	Z	0	0
8	8	Z	0	0
9	8	Z	0	0
10	8	Z	0	0

Member Point Loads (BLC 7 : 90 Wind - Service)

	Member Label	Direction	Magnitude [k, k-ft]	Location [(ft, %)]
1	32	X	-0.007	%15
2	32	X	-0.007	%85
3	32	X	-0.003	%20
4	32	X	-0.003	%50
5	32	X	0	0
6	8	X	-0.003	%50
7	8	X	0	0
8	8	X	0	0
9	8	X	0	0
10	8	X	0	0

Member Point Loads (BLC 8 : Ice)

	Member Label	Direction	Magnitude [k, k-ft]	Location [(ft, %)]
1	32	Y	-0.19	%15
2	32	Y	-0.19	%85
3	32	Y	-0.069	%20
4	32	Y	-0.067	%50
5	32	Y	0	0
6	8	Y	-0.07	%50
7	8	Y	0	0
8	8	Y	0	0
9	8	Y	0	0
10	8	Y	0	0

Member Point Loads (BLC 13 : Maint LL 1)

	Member Label	Direction	Magnitude [k, k-ft]	Location [(ft, %)]
1	8	Y	-0.25	%50



Member Point Loads (BLC 14 : Maint LL 2)

	Member Label	Direction	Magnitude [k, k-ft]	Location [(ft, %)]
1	16	Y	-0.25	%50

Member Point Loads (BLC 15 : Maint LL 3)

	Member Label	Direction	Magnitude [k, k-ft]	Location [(ft, %)]
1	4	Y	-0.25	%50

Member Point Loads (BLC 16 : Maint LL 4)

	Member Label	Direction	Magnitude [k, k-ft]	Location [(ft, %)]
1	12	Y	-0.25	%50

Member Point Loads (BLC 17 : Maint LL 5)

	Member Label	Direction	Magnitude [k, k-ft]	Location [(ft, %)]
1	2	Y	-0.25	%95

Member Point Loads (BLC 18 : Maint LL 6)

	Member Label	Direction	Magnitude [k, k-ft]	Location [(ft, %)]
1	1	Y	-0.25	%95

Member Distributed Loads (BLC 2 : 0 Wind - No Ice)

	Member Label	Direction	Start Magnitude [k/ft, F, ksf, k-ft/ft]	End Magnitude [k/ft, F, ksf, k-ft/ft]	Start Location [(ft, %)]	End Location [(ft, %)]
1	1	Z	-0.012	-0.012	0	%100
2	2	Z	-0.012	-0.012	0	%100
3	3	Z	-0.003	-0.003	0	%100
4	4	Z	-0.007	-0.007	0	%100
5	5	Z	-0.003	-0.003	0	%100
6	7	Z	-0.003	-0.003	0	%100
7	8	Z	-0.007	-0.007	0	%100
8	9	Z	-0.003	-0.003	0	%100
9	11	Z	-0.003	-0.003	0	%100
10	12	Z	-0.007	-0.007	0	%100
11	13	Z	-0.003	-0.003	0	%100
12	15	Z	-0.003	-0.003	0	%100
13	16	Z	-0.007	-0.007	0	%100
14	17	Z	-0.003	-0.003	0	%100
15	19	Z	-0.003	-0.003	0	%100
16	20	Z	-0.003	-0.003	0	%100
17	21	Z	-0.002	-0.002	0	%100
18	22	Z	-0.002	-0.002	0	%100
19	23	Z	-0.003	-0.003	0	%100
20	24	Z	-0.003	-0.003	0	%100
21	25	Z	-0.002	-0.002	0	%100
22	26	Z	-0.002	-0.002	0	%100
23	29	Z	-0.012	-0.012	0	%100
24	32	Z	-0.012	-0.012	0	%100
25	35	Z	-0.012	-0.012	0	%100
26	36	Z	-0.01	-0.01	0	%100



Company : B+T Group
 Designer : MSP
 Job Number : 149562.005.01.0001
 Model Name : MA12227-A - Truro

10/27/2023
 5:15:23 PM
 Checked By : _____

Member Distributed Loads (BLC 3 : 90 Wind - No Ice)

Member	Label	Direction	Start Magnitude [k/ft, F, ksf, k-ft/ft]	End Magnitude [k/ft, F, ksf, k-ft/ft]	Start Location [(ft, %)]	End Location [(ft, %)]
1	1	X	-0.012	-0.012	0	%100
2	2	X	-0.012	-0.012	0	%100
3	3	X	-0.003	-0.003	0	%100
4	4	X	-0.007	-0.007	0	%100
5	5	X	-0.003	-0.003	0	%100
6	7	X	-0.003	-0.003	0	%100
7	8	X	-0.007	-0.007	0	%100
8	9	X	-0.003	-0.003	0	%100
9	11	X	-0.003	-0.003	0	%100
10	12	X	-0.007	-0.007	0	%100
11	13	X	-0.003	-0.003	0	%100
12	15	X	-0.003	-0.003	0	%100
13	16	X	-0.007	-0.007	0	%100
14	17	X	-0.003	-0.003	0	%100
15	19	X	-0.003	-0.003	0	%100
16	20	X	-0.003	-0.003	0	%100
17	21	X	-0.002	-0.002	0	%100
18	22	X	-0.002	-0.002	0	%100
19	23	X	-0.003	-0.003	0	%100
20	24	X	-0.003	-0.003	0	%100
21	25	X	-0.002	-0.002	0	%100
22	26	X	-0.002	-0.002	0	%100
23	29	X	-0.012	-0.012	0	%100
24	32	X	-0.012	-0.012	0	%100
25	35	X	-0.012	-0.012	0	%100
26	36	X	-0.01	-0.01	0	%100

Member Distributed Loads (BLC 4 : 0 Wind - Ice)

Member	Label	Direction	Start Magnitude [k/ft, F, ksf, k-ft/ft]	End Magnitude [k/ft, F, ksf, k-ft/ft]	Start Location [(ft, %)]	End Location [(ft, %)]
1	1	Z	-0.003	-0.003	0	%100
2	2	Z	-0.003	-0.003	0	%100
3	3	Z	-0.007	-0.007	0	%100
4	4	Z	-0.002	-0.002	0	%100
5	5	Z	-0.007	-0.007	0	%100
6	7	Z	-0.007	-0.007	0	%100
7	8	Z	-0.002	-0.002	0	%100
8	9	Z	-0.007	-0.007	0	%100
9	11	Z	-0.007	-0.007	0	%100
10	12	Z	-0.002	-0.002	0	%100
11	13	Z	-0.007	-0.007	0	%100
12	15	Z	-0.007	-0.007	0	%100
13	16	Z	-0.002	-0.002	0	%100
14	17	Z	-0.007	-0.007	0	%100
15	19	Z	-0.003	-0.003	0	%100
16	20	Z	-0.003	-0.003	0	%100
17	21	Z	-0.001	-0.001	0	%100
18	22	Z	-0.001	-0.001	0	%100
19	23	Z	-0.003	-0.003	0	%100
20	24	Z	-0.003	-0.003	0	%100
21	25	Z	-0.001	-0.001	0	%100
22	26	Z	-0.001	-0.001	0	%100
23	29	Z	-0.003	-0.003	0	%100
24	32	Z	-0.003	-0.003	0	%100
25	35	Z	-0.003	-0.003	0	%100



Company : B+T Group
 Designer : MSP
 Job Number : 149562.005.01.0001
 Model Name : MA12227-A - Truro

10/27/2023
 5:15:23 PM
 Checked By : _____

Member Distributed Loads (BLC 4 : 0 Wind - Ice) (Continued)

Member	Label	Direction	Start Magnitude [k/ft, F, ksf, k-ft/ft]	End Magnitude [k/ft, F, ksf, k-ft/ft]	Start Location [(ft, %)]	End Location [(ft, %)]
26	36	Z	-0.002	-0.002	0	%100

Member Distributed Loads (BLC 5 : 90 Wind - Ice)

Member	Label	Direction	Start Magnitude [k/ft, F, ksf, k-ft/ft]	End Magnitude [k/ft, F, ksf, k-ft/ft]	Start Location [(ft, %)]	End Location [(ft, %)]
1	1	X	-0.003	-0.003	0	%100
2	2	X	-0.003	-0.003	0	%100
3	3	X	-0.007	-0.007	0	%100
4	4	X	-0.002	-0.002	0	%100
5	5	X	-0.007	-0.007	0	%100
6	7	X	-0.007	-0.007	0	%100
7	8	X	-0.002	-0.002	0	%100
8	9	X	-0.007	-0.007	0	%100
9	11	X	-0.007	-0.007	0	%100
10	12	X	-0.002	-0.002	0	%100
11	13	X	-0.007	-0.007	0	%100
12	15	X	-0.007	-0.007	0	%100
13	16	X	-0.002	-0.002	0	%100
14	17	X	-0.007	-0.007	0	%100
15	19	X	-0.003	-0.003	0	%100
16	20	X	-0.003	-0.003	0	%100
17	21	X	-0.001	-0.001	0	%100
18	22	X	-0.001	-0.001	0	%100
19	23	X	-0.003	-0.003	0	%100
20	24	X	-0.003	-0.003	0	%100
21	25	X	-0.001	-0.001	0	%100
22	26	X	-0.001	-0.001	0	%100
23	29	X	-0.003	-0.003	0	%100
24	32	X	-0.003	-0.003	0	%100
25	35	X	-0.003	-0.003	0	%100
26	36	X	-0.002	-0.002	0	%100

Member Distributed Loads (BLC 6 : 0 Wind - Service)

Member	Label	Direction	Start Magnitude [k/ft, F, ksf, k-ft/ft]	End Magnitude [k/ft, F, ksf, k-ft/ft]	Start Location [(ft, %)]	End Location [(ft, %)]
1	1	Z	-0.0004	-0.0004	0	%100
2	2	Z	-0.0004	-0.0004	0	%100
3	3	Z	-0.0002	-0.0002	0	%100
4	4	Z	-0.0003	-0.0003	0	%100
5	5	Z	-0.0002	-0.0002	0	%100
6	7	Z	-0.0002	-0.0002	0	%100
7	8	Z	-0.0003	-0.0003	0	%100
8	9	Z	-0.0002	-0.0002	0	%100
9	11	Z	-0.0002	-0.0002	0	%100
10	12	Z	-0.0003	-0.0003	0	%100
11	13	Z	-0.0002	-0.0002	0	%100
12	15	Z	-0.0002	-0.0002	0	%100
13	16	Z	-0.0003	-0.0003	0	%100
14	17	Z	-0.0002	-0.0002	0	%100
15	19	Z	-0.0001	-0.0001	0	%100
16	20	Z	-0.0001	-0.0001	0	%100
17	21	Z	-0.0001	-0.0001	0	%100
18	22	Z	-0.0001	-0.0001	0	%100
19	23	Z	-0.0001	-0.0001	0	%100
20	24	Z	-0.0001	-0.0001	0	%100

Member Distributed Loads (BLC 6 : 0 Wind - Service) (Continued)

Member	Label	Direction	Start Magnitude [k/ft, F, ksf, k-ft/ft]	End Magnitude [k/ft, F, ksf, k-ft/ft]	Start Location [(ft, %)]	End Location [(ft, %)]
21	25	Z	-0.0001	-0.0001	0	%100
22	26	Z	-0.0001	-0.0001	0	%100
23	29	Z	-0.0004	-0.0004	0	%100
24	32	Z	-0.0004	-0.0004	0	%100
25	35	Z	-0.0004	-0.0004	0	%100
26	36	Z	-0.0003	-0.0003	0	%100

Member Distributed Loads (BLC 7 : 90 Wind - Service)

Member	Label	Direction	Start Magnitude [k/ft, F, ksf, k-ft/ft]	End Magnitude [k/ft, F, ksf, k-ft/ft]	Start Location [(ft, %)]	End Location [(ft, %)]
1	1	X	-0.0004	-0.0004	0	%100
2	2	X	-0.0004	-0.0004	0	%100
3	3	X	-0.0002	-0.0002	0	%100
4	4	X	-0.0003	-0.0003	0	%100
5	5	X	-0.0002	-0.0002	0	%100
6	7	X	-0.0002	-0.0002	0	%100
7	8	X	-0.0003	-0.0003	0	%100
8	9	X	-0.0002	-0.0002	0	%100
9	11	X	-0.0002	-0.0002	0	%100
10	12	X	-0.0003	-0.0003	0	%100
11	13	X	-0.0002	-0.0002	0	%100
12	15	X	-0.0002	-0.0002	0	%100
13	16	X	-0.0003	-0.0003	0	%100
14	17	X	-0.0002	-0.0002	0	%100
15	19	X	-0.0001	-0.0001	0	%100
16	20	X	-0.0001	-0.0001	0	%100
17	21	X	-0.0001	-0.0001	0	%100
18	22	X	-0.0001	-0.0001	0	%100
19	23	X	-0.0001	-0.0001	0	%100
20	24	X	-0.0001	-0.0001	0	%100
21	25	X	-0.0001	-0.0001	0	%100
22	26	X	-0.0001	-0.0001	0	%100
23	29	X	-0.0004	-0.0004	0	%100
24	32	X	-0.0004	-0.0004	0	%100
25	35	X	-0.0004	-0.0004	0	%100
26	36	X	-0.0003	-0.0003	0	%100

Member Distributed Loads (BLC 8 : Ice)

Member	Label	Direction	Start Magnitude [k/ft, F, ksf, k-ft/ft]	End Magnitude [k/ft, F, ksf, k-ft/ft]	Start Location [(ft, %)]	End Location [(ft, %)]
1	1	Y	-0.014	-0.014	0	%100
2	2	Y	-0.014	-0.014	0	%100
3	3	Y	-0.015	-0.015	0	%100
4	4	Y	-0.011	-0.011	0	%100
5	5	Y	-0.017	-0.017	0	%100
6	7	Y	-0.015	-0.015	0	%100
7	8	Y	-0.011	-0.011	0	%100
8	9	Y	-0.017	-0.017	0	%100
9	11	Y	-0.015	-0.015	0	%100
10	12	Y	-0.011	-0.011	0	%100
11	13	Y	-0.017	-0.017	0	%100
12	15	Y	-0.015	-0.015	0	%100
13	16	Y	-0.011	-0.011	0	%100
14	17	Y	-0.017	-0.017	0	%100
15	19	Y	-0.008	-0.008	0	%100

Member Distributed Loads (BLC 8 : Ice) (Continued)

Member	Label	Direction	Start Magnitude [k/ft, F, ksf, k-ft/ft]	End Magnitude [k/ft, F, ksf, k-ft/ft]	Start Location [(ft, %)]	End Location [(ft, %)]
16	20	Y	-0.008	-0.008	0	%100
17	21	Y	-0.007	-0.007	0	%100
18	22	Y	-0.007	-0.007	0	%100
19	23	Y	-0.008	-0.008	0	%100
20	24	Y	-0.008	-0.008	0	%100
21	25	Y	-0.007	-0.007	0	%100
22	26	Y	-0.007	-0.007	0	%100
23	29	Y	-0.014	-0.014	0	%100
24	32	Y	-0.014	-0.014	0	%100
25	35	Y	-0.014	-0.014	0	%100
26	36	Y	-0.012	-0.012	0	%100

Member Area Loads

No Data to Print...						
---------------------	--	--	--	--	--	--

Node Loads and Enforced Displacements (BLC 9 : Live Load a)

Node	Label	L, D, M	Direction	Magnitude [(k, k-ft), (in, rad), (k*s ² /ft, k*s ² *ft)]
1	57	L	Y	-0.5

Node Loads and Enforced Displacements (BLC 10 : Live Load b)

Node	Label	L, D, M	Direction	Magnitude [(k, k-ft), (in, rad), (k*s ² /ft, k*s ² *ft)]
1	45	L	Y	-0.5

Node Loads and Enforced Displacements (BLC 11 : Live Load c)

Node	Label	L, D, M	Direction	Magnitude [(k, k-ft), (in, rad), (k*s ² /ft, k*s ² *ft)]
1	51	L	Y	-0.5

Basic Load Cases

	BLC Description	Category	Y Gravity	Nodal	Point	Distributed
1	Dead	DL	-1		10	
2	0 Wind - No Ice	WLZ			10	26
3	90 Wind - No Ice	WLX			10	26
4	0 Wind - Ice	WLZ			10	26
5	90 Wind - Ice	WLX			10	26
6	0 Wind - Service	WLZ			10	26
7	90 Wind - Service	WLX			10	26
8	Ice	OL1			10	26
9	Live Load a	LL		1		
10	Live Load b	LL		1		
11	Live Load c	LL		1		
12	Live Load d	LL				
13	Maint LL 1	LL			1	
14	Maint LL 2	LL			1	
15	Maint LL 3	LL			1	
16	Maint LL 4	LL			1	
17	Maint LL 5	LL			1	
18	Maint LL 6	LL			1	

Load Combinations

	Description	Solve	P-Delta	BLC	Factor	BLC	Factor	BLC	Factor	BLC	Factor
1	1.4 Dead	Yes	Y	1	1.4						
2	0.9 D + 1.6 - 0 W	Yes	Y	1	0.9	2	1.6				
3	0.9 D + 1.6 - 30 W	Yes	Y	1	0.9	2	1.386	3	0.8		
4	0.9 D + 1.6 - 60 W	Yes	Y	1	0.9	3	1.386	2	0.8		
5	0.9 D + 1.6 - 90 W	Yes	Y	1	0.9	3	1.6				
6	0.9 D + 1.6 - 120 W	Yes	Y	1	0.9	3	1.386	2	-0.8		
7	0.9 D + 1.6 - 150 W	Yes	Y	1	0.9	2	-1.386	3	0.8		
8	0.9 D + 1.6 - 180 W	Yes	Y	1	0.9	2	-1.6				
9	0.9 D + 1.6 - 210 W	Yes	Y	1	0.9	2	-1.386	3	-0.8		
10	0.9 D + 1.6 - 240 W	Yes	Y	1	0.9	3	-1.386	2	-0.8		
11	0.9 D + 1.6 - 270 W	Yes	Y	1	0.9	3	-1.6				
12	0.9 D + 1.6 - 300 W	Yes	Y	1	0.9	3	-1.386	2	0.8		
13	0.9 D + 1.6 - 330 W	Yes	Y	1	0.9	2	1.386	3	-0.8		
14	1.2 D + 1.6 - 0 W	Yes	Y	1	1.2	2	1.6				
15	1.2 D + 1.6 - 30 W	Yes	Y	1	1.2	2	1.386	3	0.8		
16	1.2 D + 1.6 - 60 W	Yes	Y	1	1.2	3	1.386	2	0.8		
17	1.2 D + 1.6 - 90 W	Yes	Y	1	1.2	3	1.6				
18	1.2 D + 1.6 - 120 W	Yes	Y	1	1.2	3	1.386	2	-0.8		
19	1.2 D + 1.6 - 150 W	Yes	Y	1	1.2	2	-1.386	3	0.8		
20	1.2 D + 1.6 - 180 W	Yes	Y	1	1.2	2	-1.6				
21	1.2 D + 1.6 - 210 W	Yes	Y	1	1.2	2	-1.386	3	-0.8		
22	1.2 D + 1.6 - 240 W	Yes	Y	1	1.2	3	-1.386	2	-0.8		
23	1.2 D + 1.6 - 270 W	Yes	Y	1	1.2	3	-1.6				
24	1.2 D + 1.6 - 300 W	Yes	Y	1	1.2	3	-1.386	2	0.8		
25	1.2 D + 1.6 - 330 W	Yes	Y	1	1.2	2	1.386	3	-0.8		
26	0.9 D + 1.6 - 0 W/Ice	Yes	Y	1	0.9	4	1.6			8	1
27	0.9 D + 1.6 - 30 W/Ice	Yes	Y	1	0.9	4	1.386	5	0.8	8	1
28	0.9 D + 1.6 - 60 W/Ice	Yes	Y	1	0.9	5	1.386	4	0.8	8	1
29	0.9 D + 1.6 - 90 W/Ice	Yes	Y	1	0.9	5	1.6			8	1
30	0.9 D + 1.6 - 120 W/Ice	Yes	Y	1	0.9	5	1.386	4	-0.8	8	1
31	0.9 D + 1.6 - 150 W/Ice	Yes	Y	1	0.9	4	-1.386	5	0.8	8	1
32	0.9 D + 1.6 - 180 W/Ice	Yes	Y	1	0.9	4	-1.6			8	1
33	0.9 D + 1.6 - 210 W/Ice	Yes	Y	1	0.9	4	-1.386	5	-0.8	8	1
34	0.9 D + 1.6 - 240 W/Ice	Yes	Y	1	0.9	5	-1.386	4	-0.8	8	1
35	0.9 D + 1.6 - 270 W/Ice	Yes	Y	1	0.9	5	-1.6			8	1
36	0.9 D + 1.6 - 300 W/Ice	Yes	Y	1	0.9	5	-1.386	4	0.8	8	1
37	0.9 D + 1.6 - 330 W/Ice	Yes	Y	1	0.9	4	1.386	5	-0.8	8	1
38	1.2 D + 1.0 - 0 W/Ice	Yes	Y	1	1.2	4	1			8	1
39	1.2 D + 1.0 - 30 W/Ice	Yes	Y	1	1.2	4	0.866	5	0.5	8	1
40	1.2 D + 1.0 - 60 W/Ice	Yes	Y	1	1.2	5	0.866	4	0.5	8	1
41	1.2 D + 1.0 - 90 W/Ice	Yes	Y	1	1.2	5	1			8	1
42	1.2 D + 1.0 - 120 W/Ice	Yes	Y	1	1.2	5	0.866	4	-0.5	8	1
43	1.2 D + 1.0 - 150 W/Ice	Yes	Y	1	1.2	4	-0.866	5	0.5	8	1
44	1.2 D + 1.0 - 180 W/Ice	Yes	Y	1	1.2	4	-1			8	1
45	1.2 D + 1.0 - 210 W/Ice	Yes	Y	1	1.2	4	-0.866	5	-0.5	8	1
46	1.2 D + 1.0 - 240 W/Ice	Yes	Y	1	1.2	5	-0.866	4	-0.5	8	1
47	1.2 D + 1.0 - 270 W/Ice	Yes	Y	1	1.2	5	-1			8	1
48	1.2 D + 1.0 - 300 W/Ice	Yes	Y	1	1.2	5	-0.866	4	0.5	8	1
49	1.2 D + 1.0 - 330 W/Ice	Yes	Y	1	1.2	4	0.866	5	-0.5	8	1
50	1.2 D + 1.5 LL a + Service - 0 W	Yes	Y	1	1.2	6	1			9	1.5
51	1.2 D + 1.5 LL a + Service - 30 W	Yes	Y	1	1.2	6	0.866	7	0.5	9	1.5
52	1.2 D + 1.5 LL a + Service - 60 W	Yes	Y	1	1.2	7	0.866	6	0.5	9	1.5
53	1.2 D + 1.5 LL a + Service - 90 W	Yes	Y	1	1.2	7	1			9	1.5
54	1.2 D + 1.5 LL a + Service - 120 W	Yes	Y	1	1.2	7	0.866	6	-0.5	9	1.5
55	1.2 D + 1.5 LL a + Service - 150 W	Yes	Y	1	1.2	6	-0.866	7	0.5	9	1.5

Load Combinations (Continued)

	Description	Solve	P-Delta	BLC	Factor	BLC	Factor	BLC	Factor	BLC	Factor
56	1.2 D + 1.5 LL a + Service - 180 W	Yes	Y	1	1.2	6	-1			9	1.5
57	1.2 D + 1.5 LL a + Service - 210 W	Yes	Y	1	1.2	6	-0.866	7	-0.5	9	1.5
58	1.2 D + 1.5 LL a + Service - 240 W	Yes	Y	1	1.2	7	-0.866	6	-0.5	9	1.5
59	1.2 D + 1.5 LL a + Service - 270 W	Yes	Y	1	1.2	7	-1			9	1.5
60	1.2 D + 1.5 LL a + Service - 300 W	Yes	Y	1	1.2	7	-0.866	6	0.5	9	1.5
61	1.2 D + 1.5 LL a + Service - 330 W	Yes	Y	1	1.2	6	0.866	7	-0.5	9	1.5
62	1.2 D + 1.5 LL b + Service - 0 W	Yes	Y	1	1.2	6	1			10	1.5
63	1.2 D + 1.5 LL b + Service - 30 W	Yes	Y	1	1.2	6	0.866	7	0.5	10	1.5
64	1.2 D + 1.5 LL b + Service - 60 W	Yes	Y	1	1.2	7	0.866	6	0.5	10	1.5
65	1.2 D + 1.5 LL b + Service - 90 W	Yes	Y	1	1.2	7	1			10	1.5
66	1.2 D + 1.5 LL b + Service - 120 W	Yes	Y	1	1.2	7	0.866	6	-0.5	10	1.5
67	1.2 D + 1.5 LL b + Service - 150 W	Yes	Y	1	1.2	6	-0.866	7	0.5	10	1.5
68	1.2 D + 1.5 LL b + Service - 180 W	Yes	Y	1	1.2	6	-1			10	1.5
69	1.2 D + 1.5 LL b + Service - 210 W	Yes	Y	1	1.2	6	-0.866	7	-0.5	10	1.5
70	1.2 D + 1.5 LL b + Service - 240 W	Yes	Y	1	1.2	7	-0.866	6	-0.5	10	1.5
71	1.2 D + 1.5 LL b + Service - 270 W	Yes	Y	1	1.2	7	-1			10	1.5
72	1.2 D + 1.5 LL b + Service - 300 W	Yes	Y	1	1.2	7	-0.866	6	0.5	10	1.5
73	1.2 D + 1.5 LL b + Service - 330 W	Yes	Y	1	1.2	6	0.866	7	-0.5	10	1.5
74	1.2 D + 1.5 LL c + Service - 0 W	Yes	Y	1	1.2	6	1			11	1.5
75	1.2 D + 1.5 LL c + Service - 30 W	Yes	Y	1	1.2	6	0.866	7	0.5	11	1.5
76	1.2 D + 1.5 LL c + Service - 60 W	Yes	Y	1	1.2	7	0.866	6	0.5	11	1.5
77	1.2 D + 1.5 LL c + Service - 90 W	Yes	Y	1	1.2	7	1			11	1.5
78	1.2 D + 1.5 LL c + Service - 120 W	Yes	Y	1	1.2	7	0.866	6	-0.5	11	1.5
79	1.2 D + 1.5 LL c + Service - 150 W	Yes	Y	1	1.2	6	-0.866	7	0.5	11	1.5
80	1.2 D + 1.5 LL c + Service - 180 W	Yes	Y	1	1.2	6	-1			11	1.5
81	1.2 D + 1.5 LL c + Service - 210 W	Yes	Y	1	1.2	6	-0.866	7	-0.5	11	1.5
82	1.2 D + 1.5 LL c + Service - 240 W	Yes	Y	1	1.2	7	-0.866	6	-0.5	11	1.5
83	1.2 D + 1.5 LL c + Service - 270 W	Yes	Y	1	1.2	7	-1			11	1.5
84	1.2 D + 1.5 LL c + Service - 300 W	Yes	Y	1	1.2	7	-0.866	6	0.5	11	1.5
85	1.2 D + 1.5 LL c + Service - 330 W	Yes	Y	1	1.2	6	0.866	7	-0.5	11	1.5
86	1.2 D + 1.5 LL d + Service - 0 W	Yes	Y	1	1.2	6	1			12	1.5
87	1.2 D + 1.5 LL d + Service - 30 W	Yes	Y	1	1.2	6	0.866	7	0.5	12	1.5
88	1.2 D + 1.5 LL d + Service - 60 W	Yes	Y	1	1.2	7	0.866	6	0.5	12	1.5
89	1.2 D + 1.5 LL d + Service - 90 W	Yes	Y	1	1.2	7	1			12	1.5
90	1.2 D + 1.5 LL d + Service - 120 W	Yes	Y	1	1.2	7	0.866	6	-0.5	12	1.5
91	1.2 D + 1.5 LL d + Service - 150 W	Yes	Y	1	1.2	6	-0.866	7	0.5	12	1.5
92	1.2 D + 1.5 LL d + Service - 180 W	Yes	Y	1	1.2	6	-1			12	1.5
93	1.2 D + 1.5 LL d + Service - 210 W	Yes	Y	1	1.2	6	-0.866	7	-0.5	12	1.5
94	1.2 D + 1.5 LL d + Service - 240 W	Yes	Y	1	1.2	7	-0.866	6	-0.5	12	1.5
95	1.2 D + 1.5 LL d + Service - 270 W	Yes	Y	1	1.2	7	-1			12	1.5
96	1.2 D + 1.5 LL d + Service - 300 W	Yes	Y	1	1.2	7	-0.866	6	0.5	12	1.5
97	1.2 D + 1.5 LL d + Service - 330 W	Yes	Y	1	1.2	6	0.866	7	-0.5	12	1.5
98	1.2 D + 1.5 LL Maint (1)	Yes	Y	1	1.2					13	1.5
99	1.2 D + 1.5 LL Maint (2)	Yes	Y	1	1.2					14	1.5
100	1.2 D + 1.5 LL Maint (3)	Yes	Y	1	1.2					15	1.5
101	1.2 D + 1.5 LL Maint (4)	Yes	Y	1	1.2					16	1.5
102	1.2 D + 1.5 LL Maint (5)	Yes	Y	1	1.2					17	1.5
103	1.2 D + 1.5 LL Maint (6)	Yes	Y	1	1.2					18	1.5

Envelope Node Reactions

Node Label	X [k]	LC	Y [k]	LC	Z [k]	LC	MX [k-ft]	LC	MY [k-ft]	LC	MZ [k-ft]	LC		
0	12	max	0.706	53	1.145	42	2.702	13	-0.002	7	0	103	0.218	78
1		min	-1.291	83	0.171	12	-3.602	19	-0.333	49	0	1	-0.128	61
2	27	max	1.279	77	1.05	48	1.966	38	0.026	8	0	103	0.191	79
3		min	-0.694	59	0.152	6	-0.287	8	-0.308	38	0	1	-0.117	61

Envelope Node Reactions (Continued)

Node Label		X [k]	LC	Y [k]	LC	Z [k]	LC	MX [k-ft]	LC	MY [k-ft]	LC	MZ [k-ft]	LC	
4	63	max	0.324	18	0.08	48	1.654	18	0	103	0	103	0	103
5		min	-0.325	24	0.013	7	-1.656	24	0	1	0	1	0	1
6	Totals:	max	1.701	17	2.251	48	2.369	2						
7		min	-1.701	11	0.46	6	-2.369	20						

Envelope AISC 13TH (360-05): LRFD Member Steel Code Checks

Member	Shape	Code	CheckLoc[ft]	LC	Shear	CheckLoc[ft]	Dir	Lcphi*Pnc [k]	phi*Pnt [k]	phi*Mn y-y [k-ft]	phi*Mn z-z [k-ft]	Cb	Eqn	
0	1	HSS2.875X0.203	0.172	6.25	20	0.096	6.25	20	33.355	65.826	4.727	4.727	1	H1-1b
1	2	HSS2.875X0.203	0.261	6.25	20	0.13	1.75	18	33.355	65.826	4.727	4.727	1	H1-1b
2	3	PL5/8X3.5	0.256	0	42	0.05	0.583	y 19	84.578	99.225	1.302	7.235	1.231	H1-1b
3	4	1.9"ODX0.12"	0.307	2.449	19	0.068	2.449	19	21.867	25.364	1.2	1.2	1	H1-1b
4	5	PL5/8X4.25	0.185	0.362	14	0.044	0.362	y 19	110.629	119.531	1.556	10.583	1.423	H1-1b
5	7	PL5/8X3.5	0.176	0	61	0.051	0.583	y 25	84.578	99.225	1.302	7.235	1.16	H1-1b
6	8	1.9"ODX0.12"	0.303	2.449	13	0.07	2.449	25	21.867	25.364	1.2	1.2	1	H1-1b
7	9	PL5/8X4.25	0.24	0.362	25	0.06	0.362	y 25	110.629	119.531	1.556	10.583	1.432	H1-1b
8	11	PL5/8X3.5	0.228	0	41	0.092	0.583	y 20	84.578	99.225	1.302	7.235	2.353	H1-1b
9	12	1.9"ODX0.12"	0.226	2.449	20	0.107	2.449	20	21.867	25.364	1.2	1.2	1	H1-1b
10	13	PL5/8X4.25	0.131	0.127	20	0.099	0.362	y 20	110.629	119.531	1.556	10.583	1.44	H1-1b
11	15	PL5/8X3.5	0.161	0	61	0.03	0	y 58	84.578	99.225	1.302	7.235	1.254	H1-1b
12	16	1.9"ODX0.12"	0.171	1.292	99	0.043	2.449	99	21.867	25.364	1.2	1.2	1	H1-1b
13	17	PL5/8X4.25	0.075	0.127	19	0.031	0.362	y 56	110.629	119.531	1.556	10.583	1.445	H1-1b
14	19	0.63"SR	0.466	2.5	41	0.004	2.5	18	1.941	14.028	0.147	0.147	1	H1-1a
15	20	0.63"SR	0.477	2.5	42	0.011	2.5	19	1.941	14.028	0.147	0.147	1	H1-1a
16	21	SR 1/2"	0.493	3.499	13	0.004	0	10	0.393	8.836	0.074	0.074	1	H1-1a
17	22	SR 1/2"	0	3.499	103	0.007	0	13	0.393	8.836	0.074	0.074	1	H1-1a
18	23	0.63"SR	0.329	0	25	0.017	0	18	1.941	14.028	0.147	0.147	1	H1-1a
19	24	0.63"SR	0.346	2.5	61	0.011	2.5	19	1.941	14.028	0.147	0.147	1	H1-1a
20	25	SR 1/2"	0.192	0	61	0.005	3.499	36	0.393	8.836	0.074	0.074	1	H1-1b*
21	26	SR 1/2"	0.024	3.499	6	0.017	0	19	0.393	8.836	0.074	0.074	1	H1-1b*
22	29	PIPE2.875X0.12	0.154	2.75	19	0.059	2.75	19	22.398	42.998	3.144	3.144	1	H1-1b
23	32	PIPE2.875X0.12	0.292	2.75	14	0.067	2.75	2	22.398	42.998	3.144	3.144	1	H1-1b
24	35	PIPE2.875X0.12	0.122	5.25	55	0.049	2.75	18	22.398	42.998	3.144	3.144	1	H1-1b
25	36	PIPE2.38X0.12	0.298	5.05	18	0.008	10.315	23	8.036	35.273	2.115	2.115	1	H1-1a

APPENDIX B

(Additional Calculations)



ASCE 7 Hazards Report

Address:
No Address at This Location

Standard: ASCE/SEI 7-10
Risk Category: III
Soil Class: D - Stiff Soil

Latitude: 41.985783
Longitude: -70.041333
Elevation: 29.375566586343556 ft (NAVD 88)

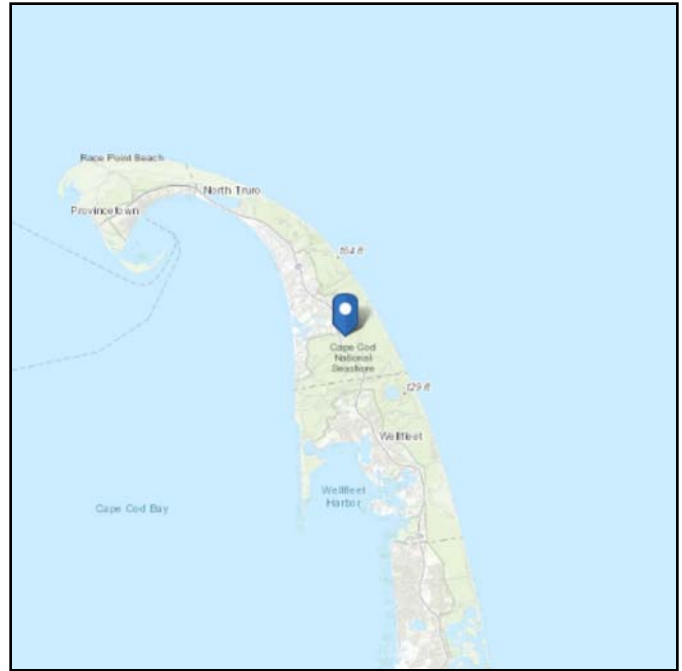
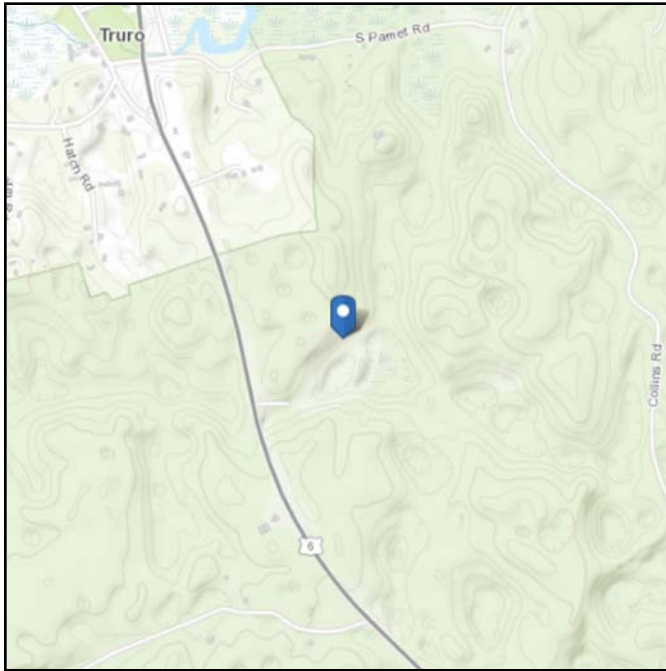

Site Soil Class:

Results:

S_s :	0.163	S_{D1} :	0.091
S_1 :	0.057	T_L :	6
F_a :	1.6	PGA :	0.084
F_v :	2.4	PGA _M :	0.134
S_{MS} :	0.26	F_{PGA} :	1.6
S_{M1} :	0.137	I_e :	1.25
S_{DS} :	0.173		

Seismic Design Category: B

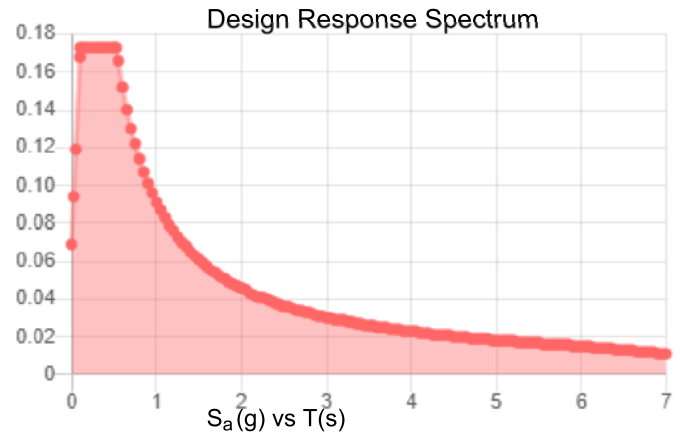
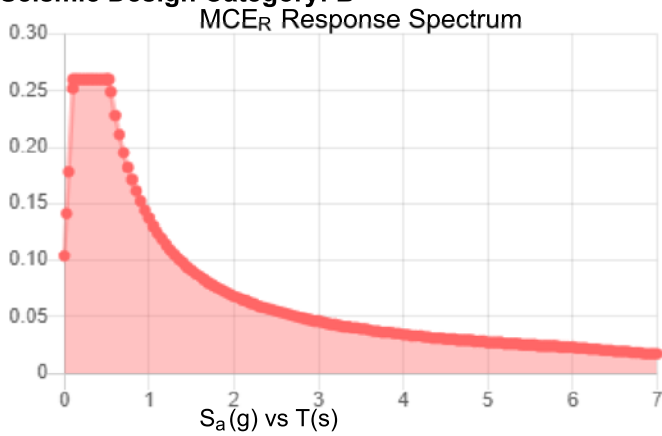

Data Accessed: Fri Oct 27 2023

Date Source:

USGS Seismic Design Maps based on ASCE/SEI 7-10, incorporating Supplement 1 and errata of March 31, 2013, and ASCE/SEI 7-10 Table 1.5-2. Additional data for site-specific ground motion procedures in accordance with ASCE/SEI 7-10 Ch. 21 are available from USGS.

Ice

Results:

Ice Thickness: 0.75 in.

Concurrent Temperature: 15 F

Gust Speed 50 mph

Data Source: Standard ASCE/SEI 7-10, Figs. 10-2 through 10-8

Date Accessed: Fri Oct 27 2023

Ice thicknesses on structures in exposed locations at elevations higher than the surrounding terrain and in valleys and gorges may exceed the mapped values.

Values provided are equivalent radial ice thicknesses due to freezing rain with concurrent 3-second gust speeds, for a 50-year mean recurrence interval, and temperatures concurrent with ice thicknesses due to freezing rain. Thicknesses for ice accretions caused by other sources shall be obtained from local meteorological studies. Ice thicknesses in exposed locations at elevations higher than the surrounding terrain and in valleys and gorges may exceed the mapped values.

The ASCE 7 Hazard Tool is provided for your convenience, for informational purposes only, and is provided “as is” and without warranties of any kind. The location data included herein has been obtained from information developed, produced, and maintained by third party providers; or has been extrapolated from maps incorporated in the ASCE 7 standard. While ASCE has made every effort to use data obtained from reliable sources or methodologies, ASCE does not make any representations or warranties as to the accuracy, completeness, reliability, currency, or quality of any data provided herein. Any third-party links provided by this Tool should not be construed as an endorsement, affiliation, relationship, or sponsorship of such third-party content by or from ASCE.

ASCE does not intend, nor should anyone interpret, the results provided by this Tool to replace the sound judgment of a competent professional, having knowledge and experience in the appropriate field(s) of practice, nor to substitute for the standard of care required of such professionals in interpreting and applying the contents of this Tool or the ASCE 7 standard.

In using this Tool, you expressly assume all risks associated with your use. Under no circumstances shall ASCE or its officers, directors, employees, members, affiliates, or agents be liable to you or any other person for any direct, indirect, special, incidental, or consequential damages arising from or related to your use of, or reliance on, the Tool or any information obtained therein. To the fullest extent permitted by law, you agree to release and hold harmless ASCE from any and all liability of any nature arising out of or resulting from any use of data provided by the ASCE 7 Hazard Tool.



DISH Wireless L.L.C. SITE ID:

BOBOS00593A

DISH Wireless L.L.C. SITE ADDRESS:

**5 TOWN DUMP ROAD
TRURO, MA 02666**

SCOPE OF WORK	
THIS IS NOT AN ALL INCLUSIVE LIST. CONTRACTOR SHALL UTILIZE SPECIFIED EQUIPMENT PART OR ENGINEER APPROVED EQUIVALENT. CONTRACTOR SHALL VERIFY ALL NEEDED EQUIPMENT TO PROVIDE A FUNCTIONAL SITE. THE PROJECT GENERALLY CONSISTS OF THE FOLLOWING:	
TOWER SCOPE OF WORK:	
<ul style="list-style-type: none"> • INSTALL (3) PROPOSED PANEL ANTENNAS (1 PER SECTOR) • INSTALL (3) PROPOSED ANTENNA MOUNTS (1 PER SECTOR) • INSTALL PROPOSED JUMPERS • INSTALL (6) PROPOSED RRUs (2 PER SECTOR) • INSTALL (1) PROPOSED OVER VOLTAGE PROTECTION DEVICE (OVP) • INSTALL (1) PROPOSED HYBRID CABLE 	
GROUND SCOPE OF WORK:	
<ul style="list-style-type: none"> • INSTALL (1) PROPOSED CONCRETE PAD • INSTALL (1) PROPOSED ICE BRIDGE • INSTALL (1) PROPOSED PPC CABINET • INSTALL (1) PROPOSED EQUIPMENT CABINET • INSTALL (1) PROPOSED POWER CONDUIT • INSTALL (1) PROPOSED TELCO CONDUIT • INSTALL (1) PROPOSED TELCO-FIBER BOX • INSTALL (1) PROPOSED GPS UNIT • INSTALL (1) PROPOSED FIBER NID (IF REQUIRED) 	

SITE INFORMATION	PROJECT DIRECTORY
PROPERTY OWNER: S B A TOWERS II LLC ADDRESS: TAX DEPT MA122227-A 8051 CONGRESS AVE BOCA RATON, FL 33487 SELF-SUPPORT TOWER	APPLICANT: DISH Wireless L.L.C. 5701 SOUTH SANTA FE DRIVE LITTLETON, CO 80120
TOWER TYPE:	TOWER OWNER: SBA COMMUNICATAIONS CORP. 8051 CONGRESS AVENUE BOCA RATON, FL 33487 (800) 487-7483
TOWER CO SITE ID: MA12227-A	SITE DESIGNER: B+T GROUP 1717 S. BOULDER AVE, SUITE 300 TULSA, OK 74119 (918) 587-4630
TOWER APP NUMBER: 163468	SITE ACQUISITION: DAVID CAMPBELL DAVID.CAMPBELL@DISH.COM
COUNTY: BARNSTABLE	CONSTRUCTION MANAGER: AARON CHANDLER AARON.CHANDLER@DISH.COM
LATITUDE (NAD 83): 41° 59' 8.82" N 41.985783 N	RF ENGINEER: ARVIN SEBASTIAN ARVIN.SEBASTIAN@DISH.COM
LONGITUDE (NAD 83): 70° 2' 28.8" W 70.041332 W	
ZONING JURISDICTION: TOWN OF TRURO	
ZONING DISTRICT: SFO	
PARCEL NUMBER: 55-2-A	
OCCUPANCY GROUP: U	
CONSTRUCTION TYPE: II-B	
POWER COMPANY: WME	
TELEPHONE COMPANY: COMCAST	



5701 SOUTH SANTA FE DRIVE
LITTLETON, CO 80120



8051 CONGRESS AVENUE
BOCA RATON, FL 33487



1717 S. BOULDER
SUITE 300
TULSA, OK 74119
PH: (918) 587-4630
www.btgrp.com



B&T ENGINEERING, INC.

IT IS A VIOLATION OF LAW FOR ANY PERSON, UNLESS THEY ARE ACTING UNDER THE DIRECTION OF A LICENSED PROFESSIONAL ENGINEER, TO ALTER THIS DOCUMENT.

DRAWN BY: RMC	CHECKED BY: BLJ	APPROVED BY: MDW
---------------	-----------------	------------------

RFDS REV #: 0

PRELIMINARY DOCUMENTS

SUBMITTALS		
REV	DATE	DESCRIPTION
A	7/28/21	ISSUED FOR REVIEW
0	8/10/21	ISSUED FOR CONSTRUCTION

A&E PROJECT NUMBER
149562.001.01

DISH Wireless L.L.C.
PROJECT INFORMATION
BOBOS00593A
5 TOWN DUMP ROAD
TRURO, MA 02666

SHEET TITLE
TITLE SHEET

SHEET NUMBER
T-1

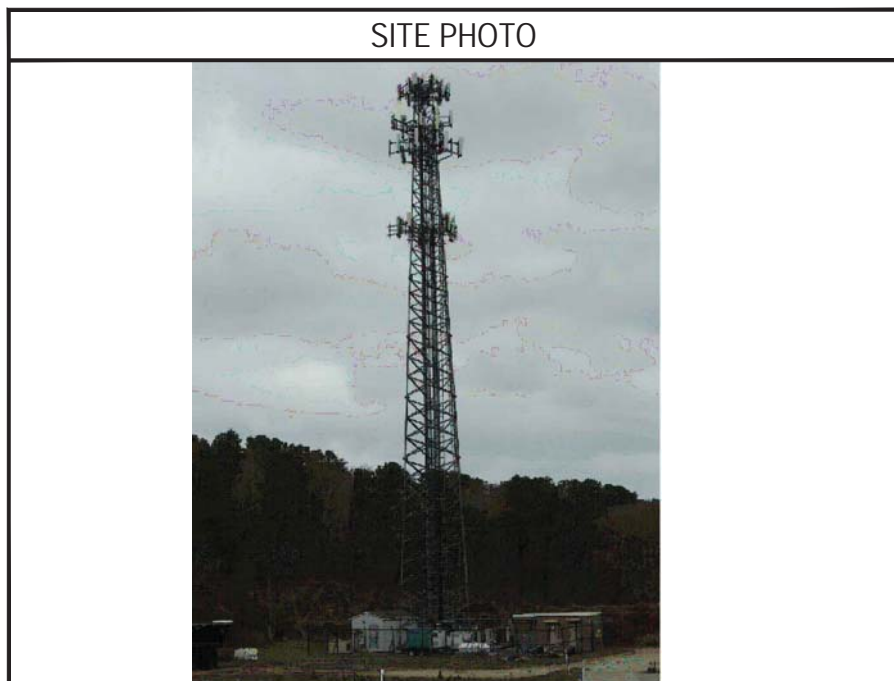

UNDERGROUND SERVICE ALERT - 811 DIG SAFE
UTILITY NOTIFICATION CENTER OF MASSACHUSETTS
(888) 344-7233
WWW.DIGSAFE.COM

CALL 3 WORKING DAYS UTILITY NOTIFICATION PRIOR TO CONSTRUCTION

GENERAL NOTES

THE FACILITY IS UNMANNED AND NOT FOR HUMAN HABITATION. A TECHNICIAN WILL VISIT THE SITE AS REQUIRED FOR ROUTINE MAINTENANCE. THE PROJECT WILL NOT RESULT IN ANY SIGNIFICANT DISTURBANCE OR EFFECT ON DRAINAGE, NO SANITARY SEWER SERVICE, POTABLE WATER, OR TRASH DISPOSAL IS REQUIRED AND NO COMMERCIAL SIGNAGE IS PROPOSED.

11"x17" PLOT WILL BE HALF SCALE UNLESS OTHERWISE NOTED

CONTRACTOR SHALL VERIFY ALL PLANS, EXISTING DIMENSIONS, AND CONDITIONS ON THE JOB SITE, AND SHALL IMMEDIATELY NOTIFY THE ENGINEER IN WRITING OF ANY DISCREPANCIES BEFORE PROCEEDING WITH THE WORK.

DIRECTIONS

DIRECTIONS FROM PROVINCETOWN MUNICIPAL AIRPORT:
HEAD EAST TOWARD PROVINCE LANDS BIKE TRAIL. TURN RIGHT ONTO RACE POINT RD. TURN LEFT ONTO US-6 W. TURN LEFT ONTO ACCESS RD AND ARRIVE AT BOBOS00593A.

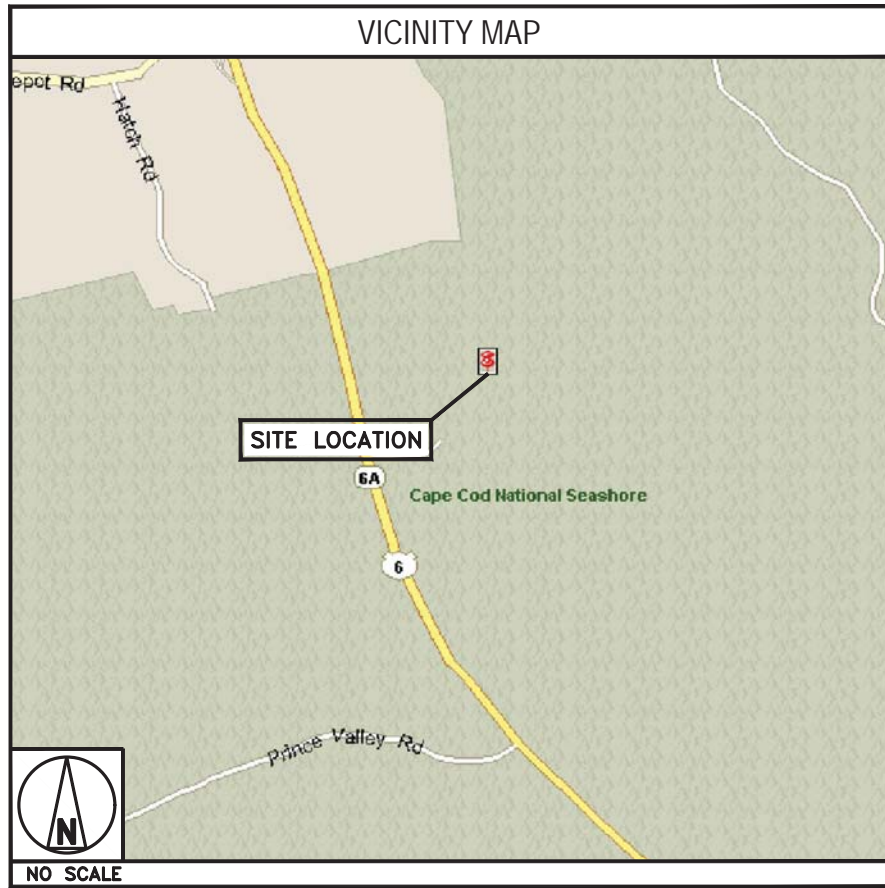

MASSACHUSETTS CODE COMPLIANCE

ALL WORK SHALL BE PERFORMED AND MATERIALS INSTALLED IN ACCORDANCE WITH THE CURRENT EDITIONS OF THE FOLLOWING CODES AS ADOPTED BY THE LOCAL GOVERNING AUTHORITIES. NOTHING IN THESE PLANS IS TO BE CONSTRUED TO PERMIT WORK NOT CONFORMING TO THESE CODES:

CODE TYPE	CODE
BUILDING	MA STATE BUILDING CODE, 9TH EDITION (780 CMR)/2015 IBC W/ AMENDMENTS
MECHANICAL	MA STATE BUILDING CODE, 9TH EDITION (780 CMR)/2015 IMC W/ AMENDMENTS
ELECTRICAL	MA ELECTRICAL CODE/2020 NEC W/ AMENDMENTS

SHEET INDEX	
SHEET NO.	SHEET TITLE
T-1	TITLE SHEET
LS1	SITE SURVEY
A-1	OVERALL AND ENLARGED SITE PLAN
A-2	ELEVATION, ANTENNA LAYOUT AND SCHEDULE
A-3	EQUIPMENT PAD AND H-FRAME DETAILS
A-4	EQUIPMENT DETAILS
A-5	EQUIPMENT DETAILS
A-6	EQUIPMENT DETAILS
E-1	ELECTRICAL/FIBER ROUTE PLAN AND NOTES
E-2	ELECTRICAL DETAILS
E-3	ELECTRICAL ONE-LINE, FAULT CALCS & PANEL SCHEDULE
G-1	GROUNDING PLANS AND NOTES
G-2	GROUNDING DETAILS
G-3	GROUNDING DETAILS
RF-1	RF CABLE COLOR CODE
GN-1	LEGEND AND ABBREVIATIONS
GN-2	GENERAL NOTES
GN-3	GENERAL NOTES
GN-4	GENERAL NOTES

GEOGRAPHIC COORDINATES OF TOWER
 41°-39'-08.82" N
 70°-02'-28.80" E
 ELEVATION AT BASE OF TOWER
 29 FEET NGVD 1929
 HEIGHT OF TOWER
 127' AGL

PLOTTABLE TITLE EXCEPTIONS			
EXCEPTION	INSTRUMENT	COMMENT	
8	PB164-P23	PER PLAN	
9	1900-61	NOT PLOTTED	

REFERENCE PLANS:

1. TOWN OF TRURO ASSESSOR'S MAPS.
2. "PLAN OF LAND IN TRURO FOR EMILY CONANT HOEFFEL AND GERALD NORTON HOEFFEL, JULY 1961, BY W.G. SLAGE SURVEYORS, RECORDED IN THE BARNSTABLE COUNTY REGISTRY OF DEED AS PB164-P23.

NOTES:

1. THERE IS A SURVEY PLAN ON RECORD FOR THE ENCUMBERED PARCEL. THE DIMENSIONS THEREON DO NOT CLOSE WELL MATHEMATICALLY. SEE REFERENCE PLAN 2.
2. CONFORMANCE WITH ALTA/ACSM LAND TITLE SURVEY STANDARDS WAS SPECIFICALLY NOT REQUESTED FOR THIS SURVEY. CERTIFICATION TO SUCH CONFORMANCE IS NOT MADE NOR IMPLIED.
3. THE SITE IS LOCATED IN FLOOD HAZARD ZONE C (AREA OF MINIMAL FLOODING) AS SHOWN ON FLOOD INSURANCE RATE MAP FOR THE TOWN OF TRURO COMMUNITY MAP PANEL 255222 0008C EFFECTIVE DATE 5/1/1992.
4. THE EXISTING ACCESS AND UTILITY EASEMENT TO THE LEASED AREA IS FLOATING AND MAY BE RELOCATED AT THE DISCRETION OF THE OWNERS OF THE ENCUMBERED PARCEL WITH RESTRICTIONS.
5. NO UNDERGROUND UTILITIES WERE LOCATED. ANY DEPICTION OF SUCH (IF ANY) ON THIS PLAN WERE DETERMINED FROM PLANS AND DOCUMENTS OF RECORD.

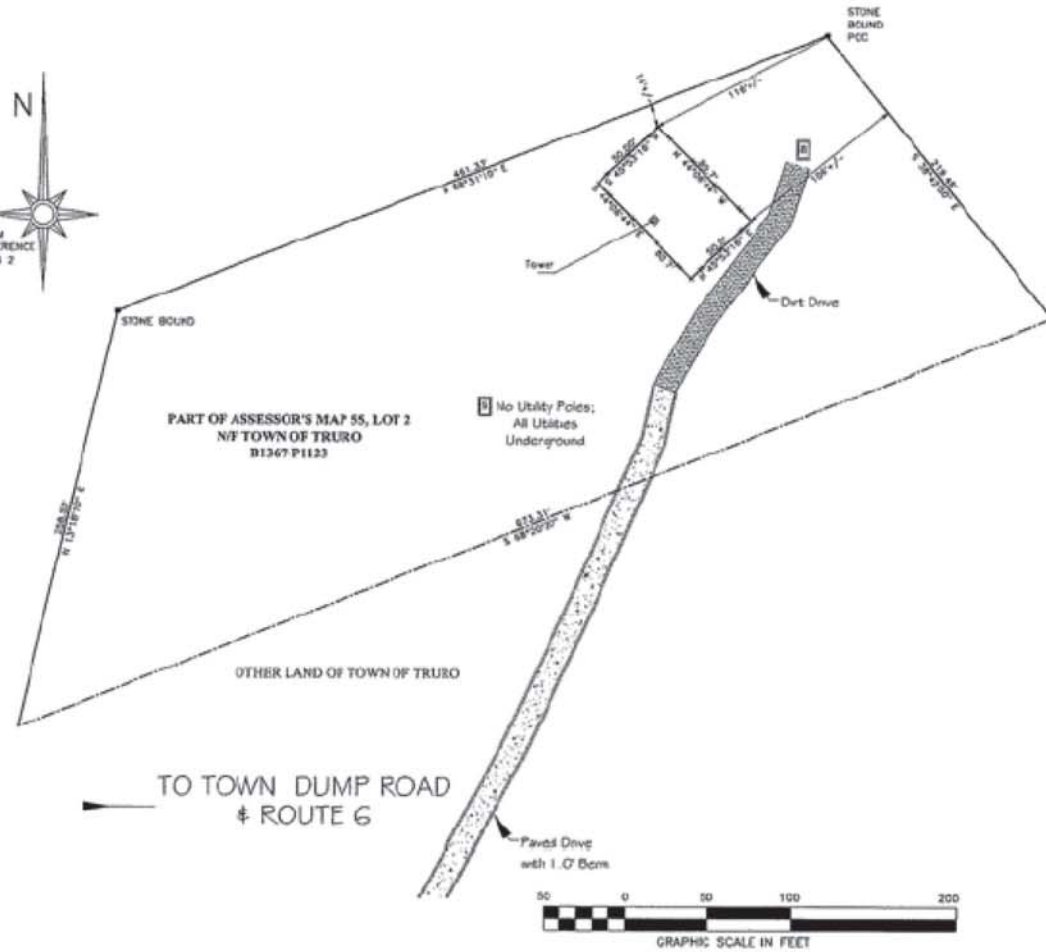
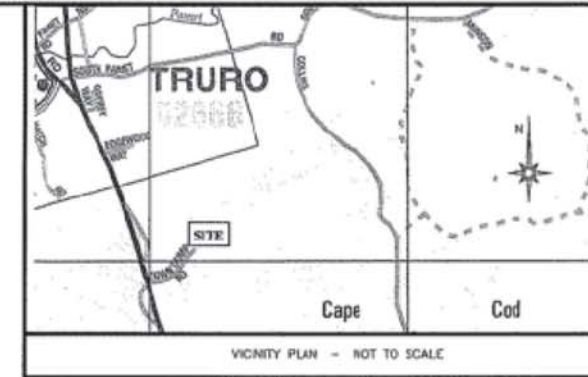

PROPOSED LEGAL DESCRIPTION OF LEASE PARCEL (SEE NOTES)

A CERTAIN PARCEL OF LAND IN THE TOWN OF TRURO, BARNSTABLE COUNTY, MASSACHUSETTS BEING A PORTION OF LAND DESCRIBED IN A DEED FROM GERALD NORTON HOEFFEL & EMILY CONANT HOEFFEL TO THE TOWN OF TRURO, RECORDED IN THE BARNSTABLE REGISTRY OF DEEDS AS BOOK 1367 PAGE 1123 AND FURTHER DESCRIBED AS FOLLOWS:

COMMENCING AT A STONE BOUND AT THE NORTHEASTERLY CORNER OF THE LESSOR'S PROPERTY AND PROCEEDING SOUTHWESTERLY ABOUT 116 FEET TO THE NORTHERLY CORNER OF THE FENCE AND THE POINT OF BEGINNING;

THENCE S 45°-53'-16" W BY THE FENCE 50.0 FEET TO THE FENCE CORNER;

THENCE S 44°-06'-44" E BY THE FENCE 80.7 FEET TO THE FENCE CORNER;

THENCE N 45°-53'-16" E BY THE FENCE 50.0 FEET TO THE FENCE CORNER;

THENCE N 44°-06'-44" W BY THE FENCE 80.7 FEET TO THE POINT OF BEGINNING.

ALONG WITH THE RIGHT TO PASS AND REPASS ON FOOT AND WITH VEHICLES, AND TO MAINTAIN UTILITIES OVER, ACROSS OR UNDER THE LESSOR'S PROPERTY AS CURRENTLY LOCATED FROM THE END OF TOWN DUMP ROAD EASTERLY TO THE LEASE SITE. SUBJECT TO THE RIGHT OF THE LESSOR TO RELOCATE SAID ACCESS AS FURTHER DESCRIBED IN THE LEASE

I HEREBY CERTIFY TO SBA TOWERS II LLC, A FLORIDA LIMITED LIABILITY COMPANY AND FIRST AMERICAN TITLE INSURANCE COMPANY THE FOLLOWING:

I HAVE RECEIVED AND REVIEWED THAT CERTAIN TITLE COMMITMENT NO. 59012531-R10 ISSUED BY FIRST AMERICAN TITLE INSURANCE COMPANY WITH AN EFFECTIVE DATE OF NOVEMBER 11, 2009, WHICH PROPOSES TO INSURE THE LANDS DESCRIBED UNDER ITS SCHEDULE A.

TO THE BEST OF MY KNOWLEDGE AND BELIEF THE LANDS DESCRIBED UNDER SAID SCHEDULE A OF THE TITLE COMMITMENT CONTAIN OR INCLUDE THE LANDS DESCRIBED IN AND DEPICTED ON THIS SURVEY.

TO THE BEST OF MY KNOWLEDGE AND BELIEF THE VISIBLE EASEMENTS OF RECORD AND IDENTIFIED UNDER SCHEDULE B-2 OF SAID COMMITMENT ENCLUMBER THE LANDS DESCRIBED ON THIS SURVEY, BUT SAID EASEMENTS WILL NOT INTERFERE WITH THE LOCATION OF THE PROPOSED INSURED LANDS, INCLUDING THE LEASED AREA AND ANY AND ALL ACCESS, UTILITY AND GUY WIRE EASEMENT PARCELS.

Timothy J. Winings
 TIMOTHY J. WININGS, MAPLS #45097

EXISTING CONDITIONS PLAN
 OF
 ASSESSOR'S MAP 55, LOTS 2 & 3
 & LEASEHOLD IMPROVEMENTS
 5 TOWN DUMP ROAD
 TRURO, MA
 DRAWN FOR
 SBA TOWERS II, LLC
 OWNER OF RECORD
 TOWN OF TRURO

DATE: 22 DECEMBER 2009
 SCALE: 1 INCH = 50 FEET

TJW SURVEY
 TIMOTHY J. WININGS, P.L.S., P.E.
 13 KEENE DRIVE
 LONGMEADOW, MA 01103-4408
 401-432-6150

#	Date	Description	By

LEGEND

	BOUNDARY		BOUND
	GRAVEL WAY		UTILITY POLE
	CHAIN LINK FENCE		TITLE EXCEPTION
	OVERHEAD UTILITIES		



5701 SOUTH SANTA FE DRIVE
 LITTLETON, CO 80120



8051 CONGRESS AVENUE
 BOCA RATON, FL 33487

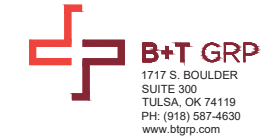

B&T ENGINEERING, INC.

IT IS A VIOLATION OF LAW FOR ANY PERSON, UNLESS THEY ARE ACTING UNDER THE DIRECTION OF A LICENSED PROFESSIONAL ENGINEER, TO ALTER THIS DOCUMENT.

DRAWN BY:	CHECKED BY:	APPROVED BY:
RMC	BLJ	MDW

RFDS REV #: 0

PRELIMINARY DOCUMENTS

SUBMITTALS		
REV	DATE	DESCRIPTION
A	7/28/21	ISSUED FOR REVIEW
0	8/10/21	ISSUED FOR CONSTRUCTION

A&E PROJECT NUMBER
 149562.001.01

DISH Wireless L.L.C.
 PROJECT INFORMATION
 BOBOS00593A
 5 TOWN DUMP ROAD
 TRURO, MA 02666

SHEET TITLE
 SURVEY SHEET

SHEET NUMBER
LS-1

NOTES

1. CONTRACTOR SHALL FIELD VERIFY ALL DIMENSIONS.
2. ANTENNAS AND MOUNTS OMITTED FOR CLARITY.

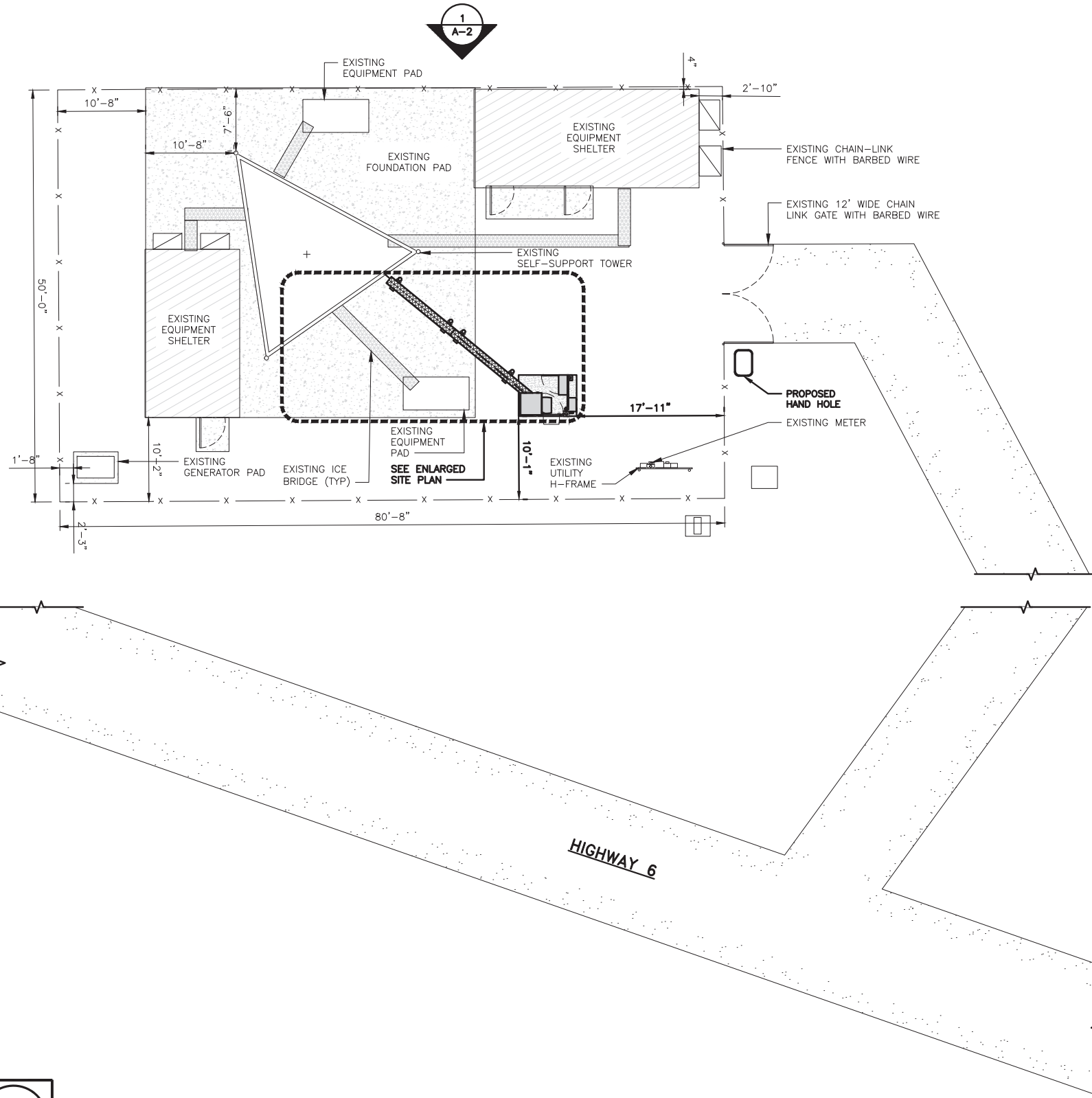

OVERALL SITE PLAN

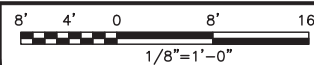

1

NOTES

1. CONTRACTOR SHALL FIELD VERIFY ALL DIMENSIONS.
2. CONTRACTOR SHALL MAINTAIN A 10'-0" MINIMUM SEPARATION BETWEEN THE PROPOSED GPS UNIT, TRANSMITTING ANTENNAS AND EXISTING GPS UNITS.
3. ANTENNAS AND MOUNTS OMITTED FOR CLARITY.

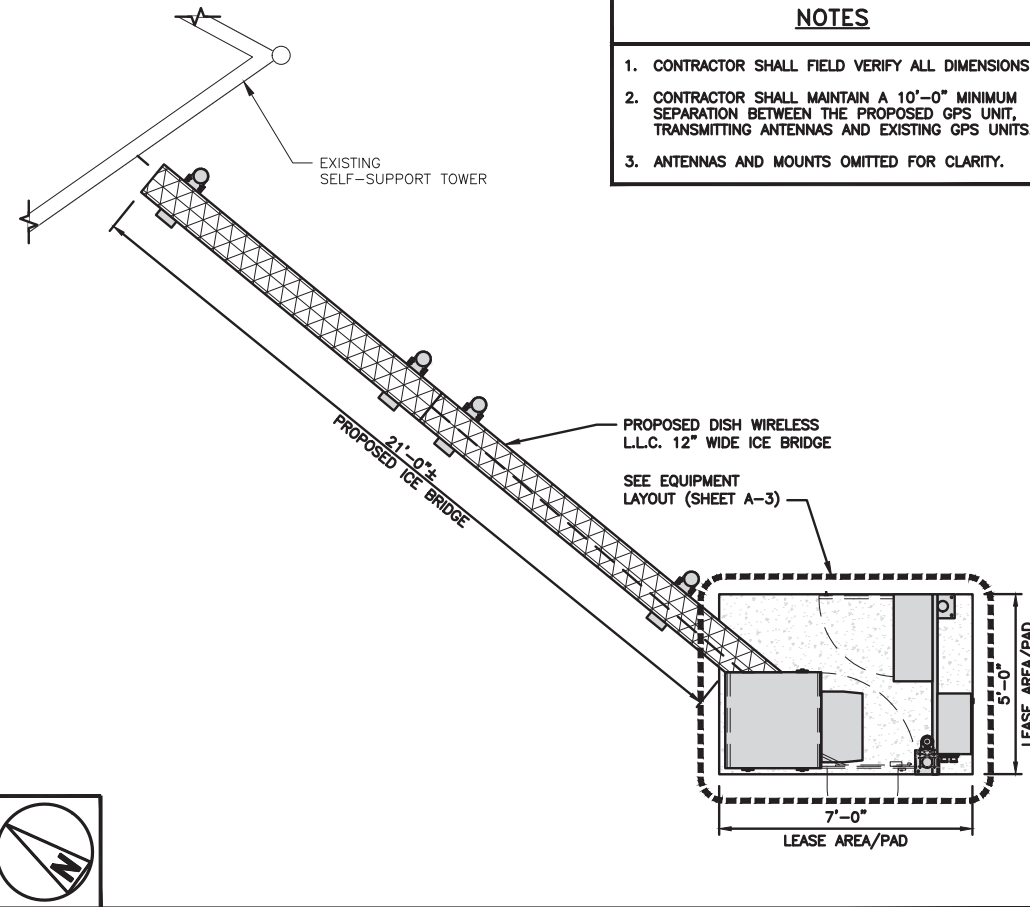

ENLARGED SITE PLAN



2

NOT USED

3



5701 SOUTH SANTA FE DRIVE
LITTLETON, CO 80120



8051 CONGRESS AVENUE
BOCA RATON, FL 33487



B&T ENGINEERING, INC.

IT IS A VIOLATION OF LAW FOR ANY PERSON, UNLESS THEY ARE ACTING UNDER THE DIRECTION OF A LICENSED PROFESSIONAL ENGINEER, TO ALTER THIS DOCUMENT.

DRAWN BY: RMC CHECKED BY: BLJ APPROVED BY: MDW

RFDS REV #: 0

PRELIMINARY DOCUMENTS

SUBMITTALS		
REV	DATE	DESCRIPTION
A	7/28/21	ISSUED FOR REVIEW
0	8/10/21	ISSUED FOR CONSTRUCTION

A&E PROJECT NUMBER
149562.001.01

DISH Wireless L.L.C.
PROJECT INFORMATION

BOBOS00593A
5 TOWN DUMP ROAD
TRURO, MA 02666

SHEET TITLE
OVERALL AND ENLARGED SITE PLAN

SHEET NUMBER

A-1

NOTES

1. CONTRACTOR SHALL FIELD VERIFY ALL DIMENSIONS.
2. ANTENNA AND MW DISH SPECIFICATIONS REFER TO ANTENNA SCHEDULE AND TO FINAL CONSTRUCTION RFDS FOR ALL RF DETAILS
3. EXISTING EQUIPMENT AND FENCE OMITTED FOR CLARITY.

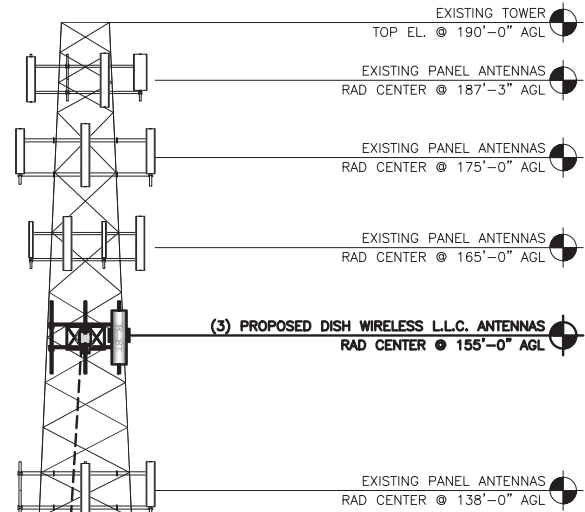

(1) PROPOSED DISH WIRELESS L.L.C. HYBRID CABLE ON EXISTING WAVEGUIDE LADDER

PROPOSED DISH WIRELESS L.L.C. ICE BRIDGE
 PROPOSED DISH WIRELESS L.L.C. EQUIPMENT ON PROPOSED CONCRETE PAD
 PROPOSED DISH WIRELESS L.L.C. GPS UNIT

PROPOSED NORTHEAST ELEVATION

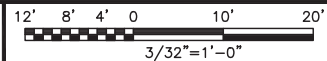

1

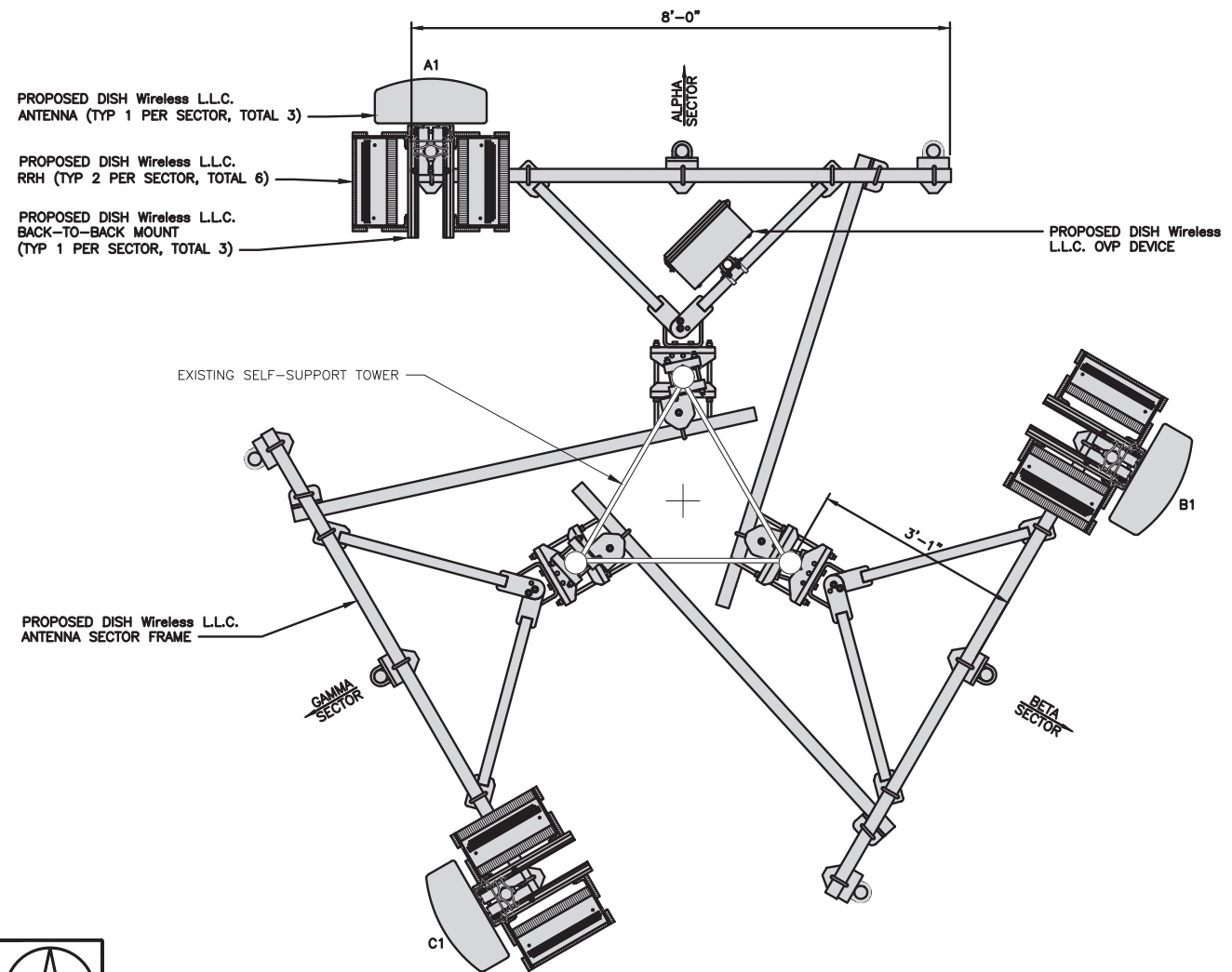

ANTENNA LAYOUT

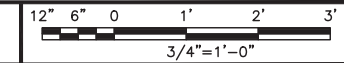

2

SECTOR	POSITION	ANTENNA					TRANSMISSION CABLE	
		EXISTING OR PROPOSED	MANUFACTURER - MODEL NUMBER	TECHNOLOGY	SIZE (HxW)	AZIMUTH	RAD CENTER	FEED LINE TYPE AND LENGTH
ALPHA	A1	PROPOSED	JMA WIRELESS-MX08FRO665-21	5G	72.0" x 20.0"	0°	155'-0"	(1) HIGH-CAPACITY HYBRID CABLE (200' LONG)
BETA	B1	PROPOSED	JMA WIRELESS-MX08FRO665-21	5G	72.0" x 20.0"	120°	155'-0"	
GAMMA	C1	PROPOSED	JMA WIRELESS-MX08FRO665-21	5G	72.0" x 20.0"	240°	155'-0"	

SECTOR	POSITION	RRH		NOTES
		MANUFACTURER - MODEL NUMBER	TECHNOLOGY	
ALPHA	A1	FUJITSU - TA08025-B605	5G	1. CONTRACTOR TO REFER TO FINAL CONSTRUCTION RFDS FOR ALL RF DETAILS. 2. ANTENNA AND RRH MODELS MAY CHANGE DUE TO EQUIPMENT AVAILABILITY. ALL EQUIPMENT CHANGES MUST BE APPROVED AND REMAIN IN COMPLIANCE WITH THE PROPOSED DESIGN AND STRUCTURAL ANALYSES.
	A1	FUJITSU - TA08025-B604	5G	
BETA	B1	FUJITSU - TA08025-B605	5G	
	B1	FUJITSU - TA08025-B604	5G	
GAMMA	C1	FUJITSU - TA08025-B605	5G	
	C1	FUJITSU - TA08025-B604	5G	

ANTENNA SCHEDULE

NO SCALE

3



5701 SOUTH SANTA FE DRIVE
LITTLETON, CO 80120



8051 CONGRESS AVENUE
BOCA RATON, FL 33487

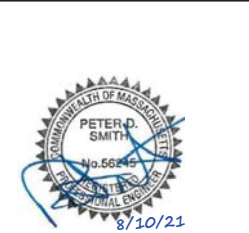

B&T ENGINEERING, INC.

IT IS A VIOLATION OF LAW FOR ANY PERSON, UNLESS THEY ARE ACTING UNDER THE DIRECTION OF A LICENSED PROFESSIONAL ENGINEER, TO ALTER THIS DOCUMENT.

DRAWN BY: CHECKED BY: APPROVED BY:

RMC BLJ MDW

RFDS REV #: 0

PRELIMINARY DOCUMENTS

SUBMITTALS		
REV	DATE	DESCRIPTION
A	7/28/21	ISSUED FOR REVIEW
0	8/10/21	ISSUED FOR CONSTRUCTION

A&E PROJECT NUMBER
149562.001.01

DISH Wireless L.L.C. PROJECT INFORMATION
 BOBOS00593A
 5 TOWN DUMP ROAD
 TRURO, MA 02666

SHEET TITLE
ELEVATION, ANTENNA LAYOUT AND SCHEDULE

SHEET NUMBER
A-2



5701 SOUTH SANTA FE DRIVE
LITTLETON, CO 80120



8051 CONGRESS AVENUE
BOCA RATON, FL 33487



1717 S. BOULDER
SUITE 300
TULSA, OK 74119
PH: (918) 587-4630
www.blgrp.com



B&T ENGINEERING, INC.

IT IS A VIOLATION OF LAW FOR ANY PERSON, UNLESS THEY ARE ACTING UNDER THE DIRECTION OF A LICENSED PROFESSIONAL ENGINEER, TO ALTER THIS DOCUMENT.

DRAWN BY: CHECKED BY: APPROVED BY:

RMC BLJ MDW

RFDS REV #: 0

PRELIMINARY DOCUMENTS

SUBMITTALS		
REV	DATE	DESCRIPTION
A	7/28/21	ISSUED FOR REVIEW
0	8/10/21	ISSUED FOR CONSTRUCTION

A&E PROJECT NUMBER

149562.001.01

DISH Wireless L.L.C.
PROJECT INFORMATION

BOBOS00593A
5 TOWN DUMP ROAD
TRURO, MA 02666

SHEET TITLE
EQUIPMENT PAD AND
H-FRAME DETAILS

SHEET NUMBER

A-3

NOTES

- CONTRACTOR TO BURY PLATFORM FEET WITH A MINIMUM OF 2" OF FILL PER EXISTING SITE SURFACE
- WEED BARRIER FABRIC TO BE ADDED AT DISCRETION OF DISH Wireless L.L.C. CONSTRUCTION MANAGER AT TIME OF CONSTRUCTION. ONE SHEET 8'x8' INSTALLED UNDER ALL FOUR FEET OF THE PLATFORM (4 MIL BLACK PLASTIC)
- EQUIPMENT CABINET OMITTED FOR CLARITY

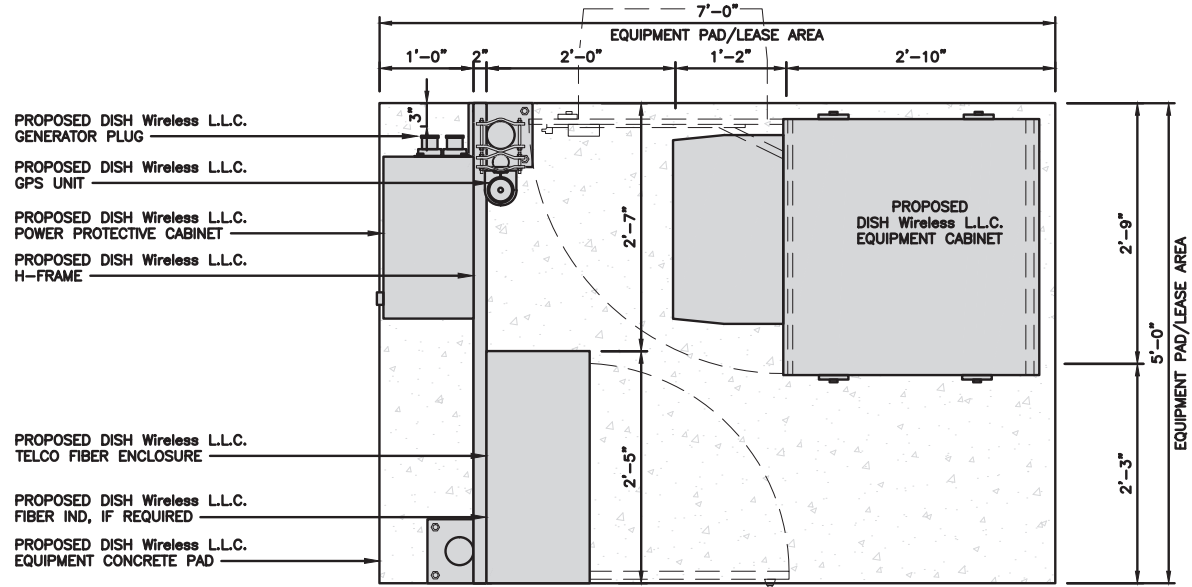

EQUIPMENT PLAN

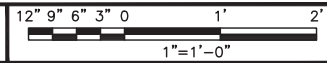

1

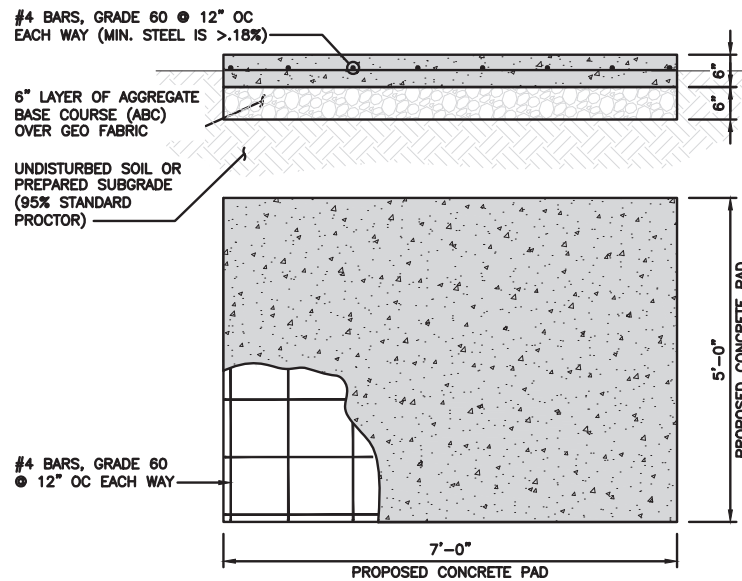

TYPICAL CONCRETE PAD DETAIL

2A

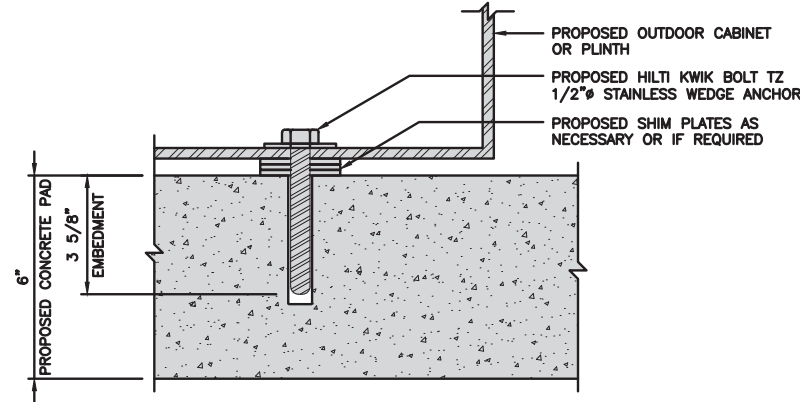

TYPICAL OUTDOOR EQUIPMENT TO CONCRETE SLAB ANCHORAGE

NO SCALE

2B

COMMSCOPE MTC4045HFLD H-FRAME	
UNISTRUT/SUPPORT RAILS QTY	5
WEIGHT	59.74 lbs

NOTE: OR DISH Wireless L.L.C. APPROVED EQUIVALENT

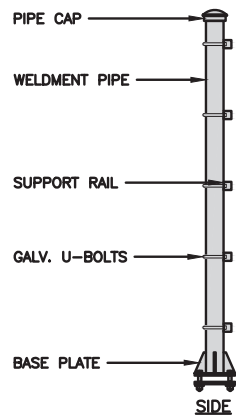

H-FRAME DETAIL

NO SCALE

3

CHARLES INDUSTRY LT-97-002422 PLINTH KIT	
DIMENSIONS (HxWxD):	6"x 32"x 32"
NOTE: GASKET AND MOUNTING HARDWARE INCLUDED	

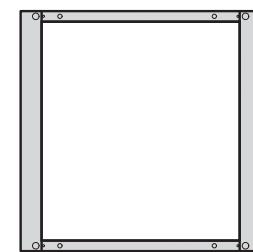

PLAN

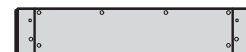

FRONT/BACK



SIDE

PLINTH DETAIL

NO SCALE

4

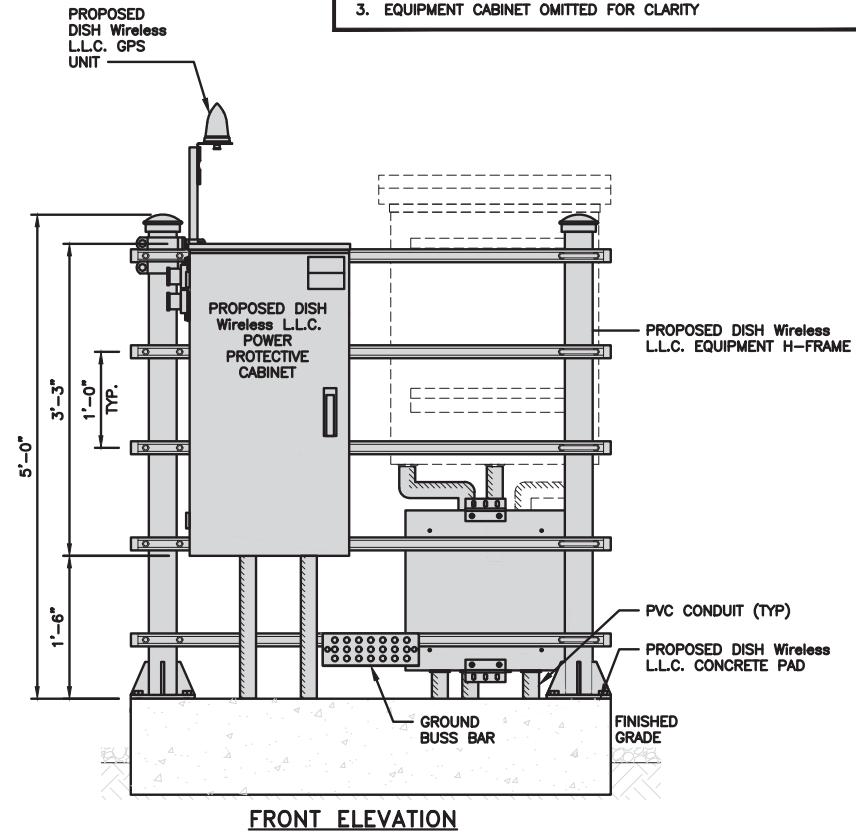

FRONT ELEVATION

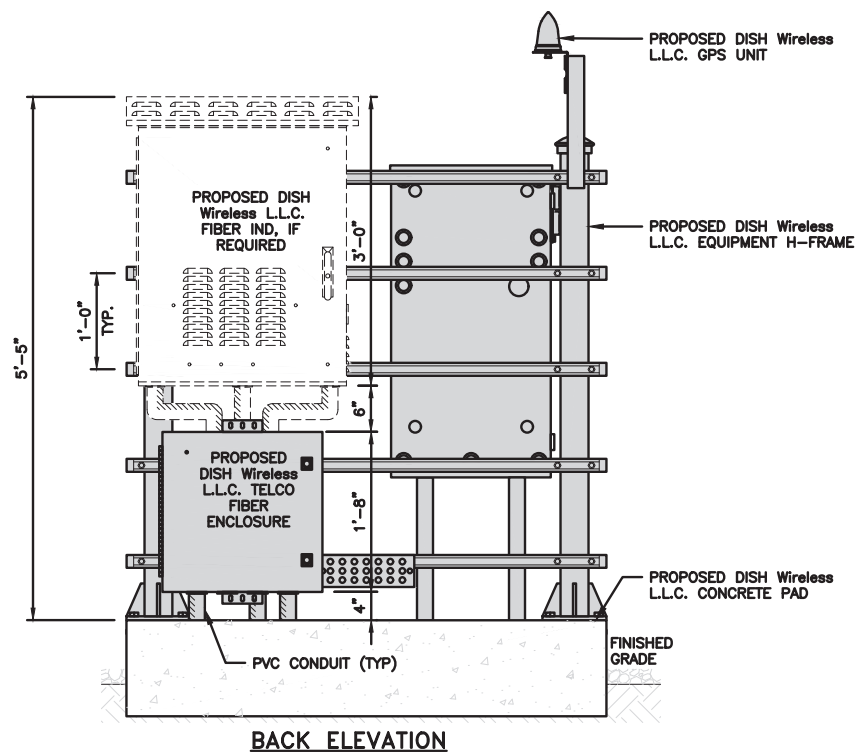

BACK ELEVATION

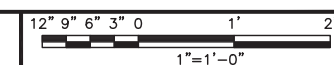

5

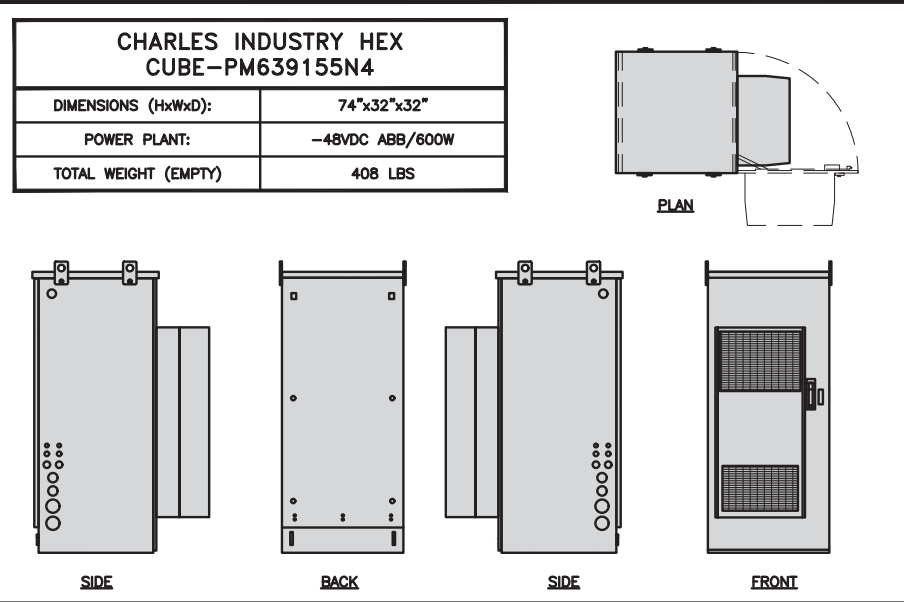

CABINET DETAIL NO SCALE 1

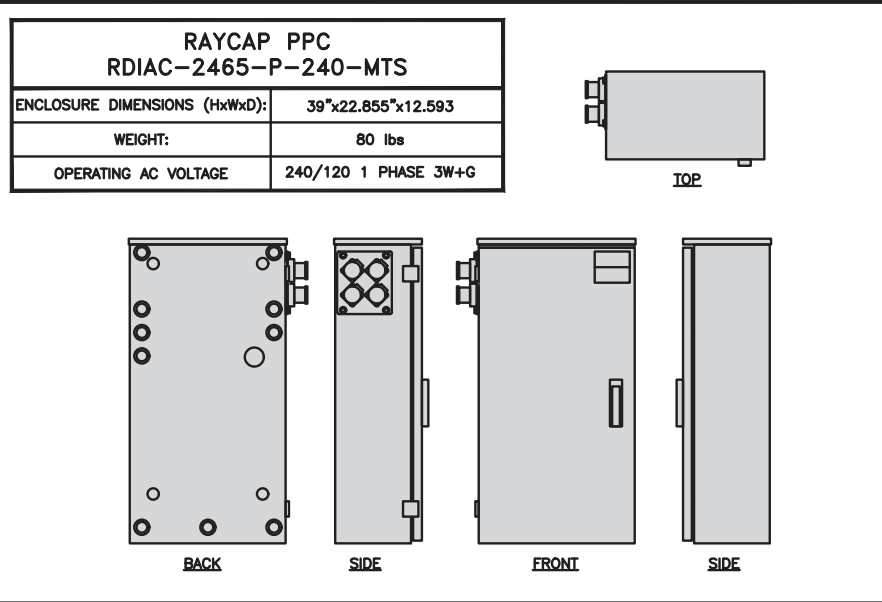

POWER PROTECTION CABINET (PPC) DETAIL NO SCALE 2

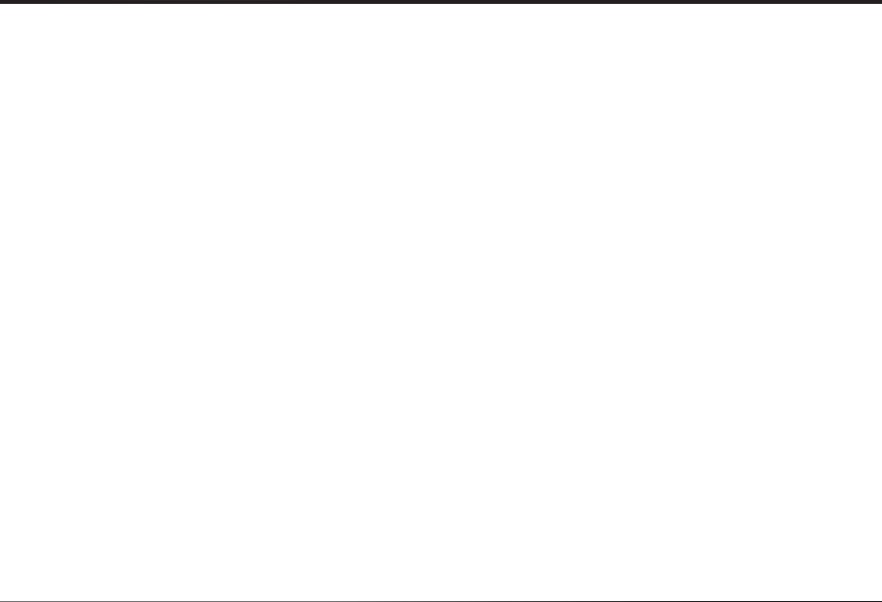

NOT USED NO SCALE 3



NOT USED NO SCALE 4

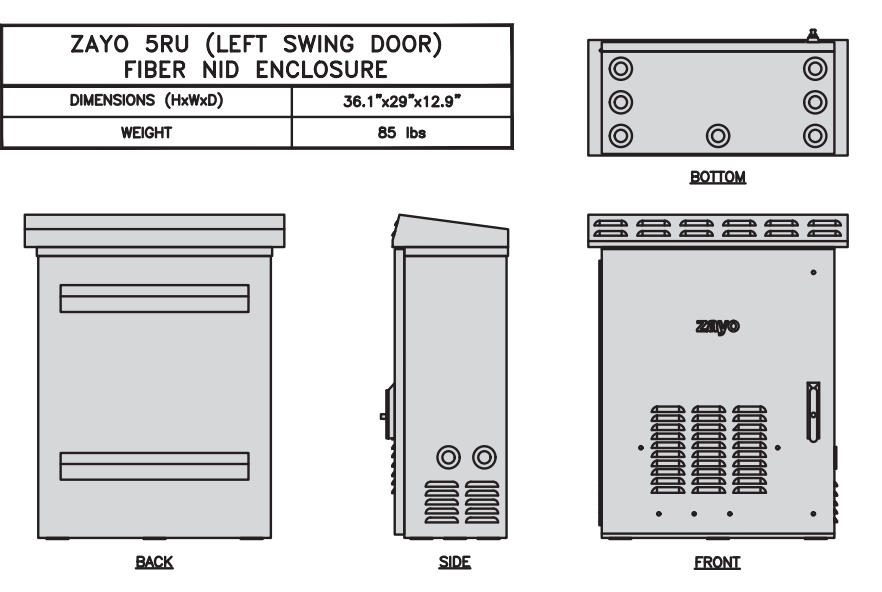

FIBER NID ENCLOSURE DETAIL NO SCALE 5

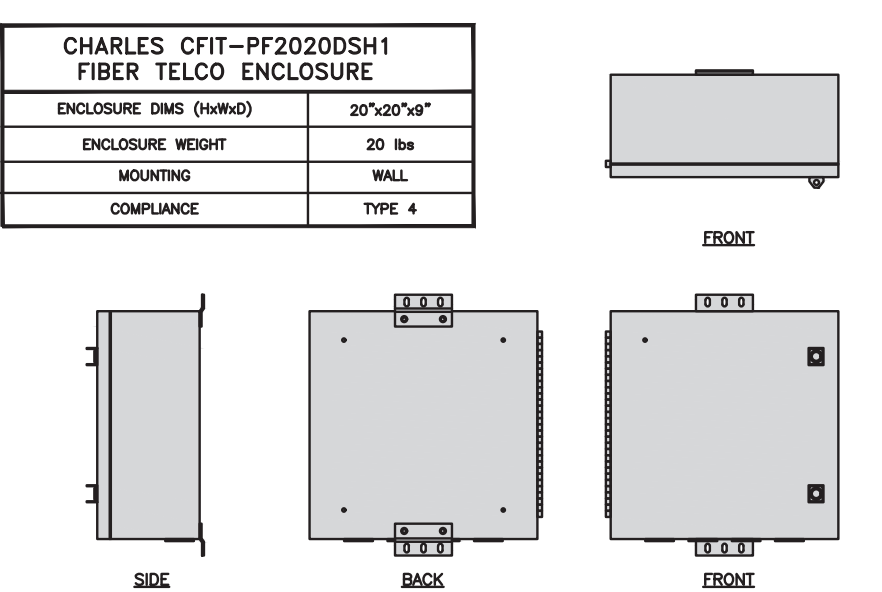

FIBER TELCO ENCLOSURE DETAIL NO SCALE 6

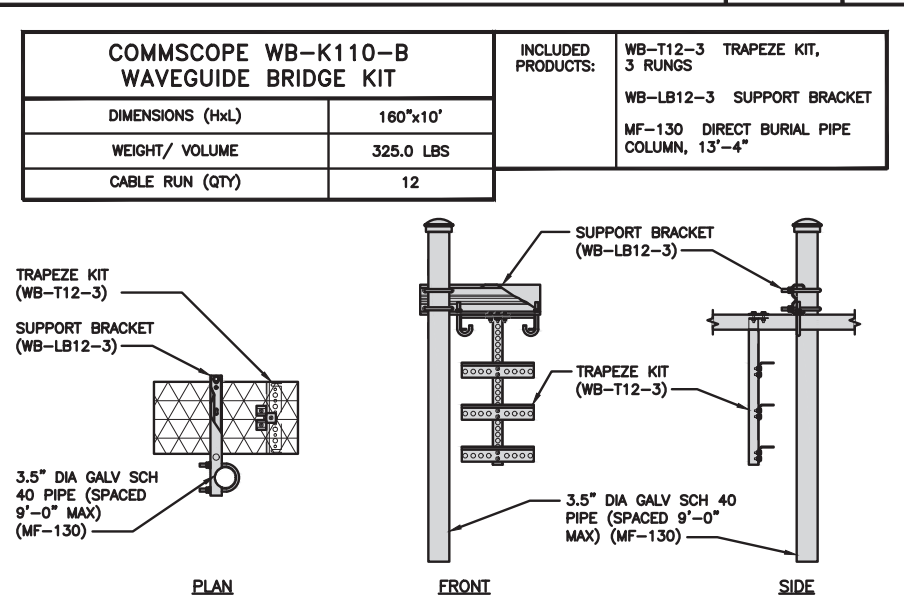

ICE BRIDGE DETAIL NO SCALE 7

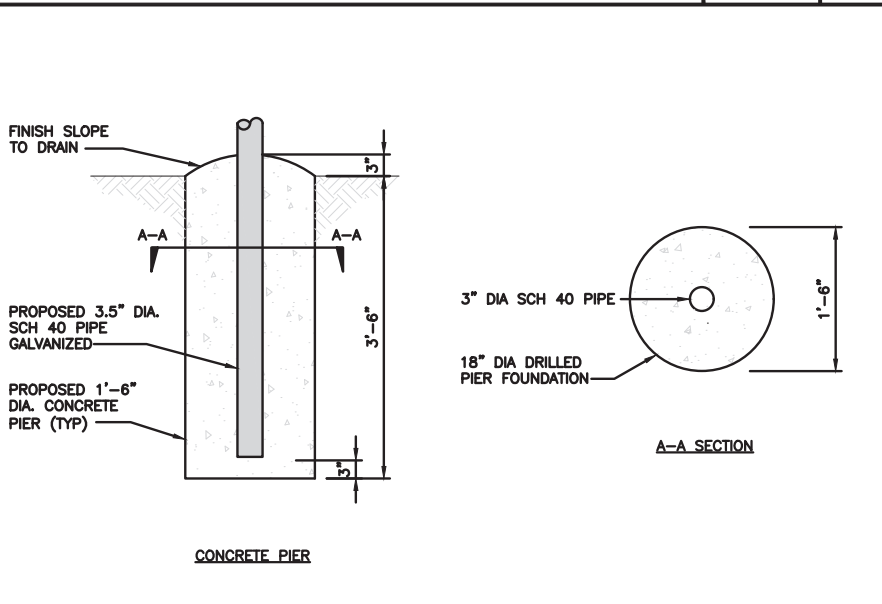

TYPICAL ICE BRIDGE CONCRETE PIER DETAIL NO SCALE 8

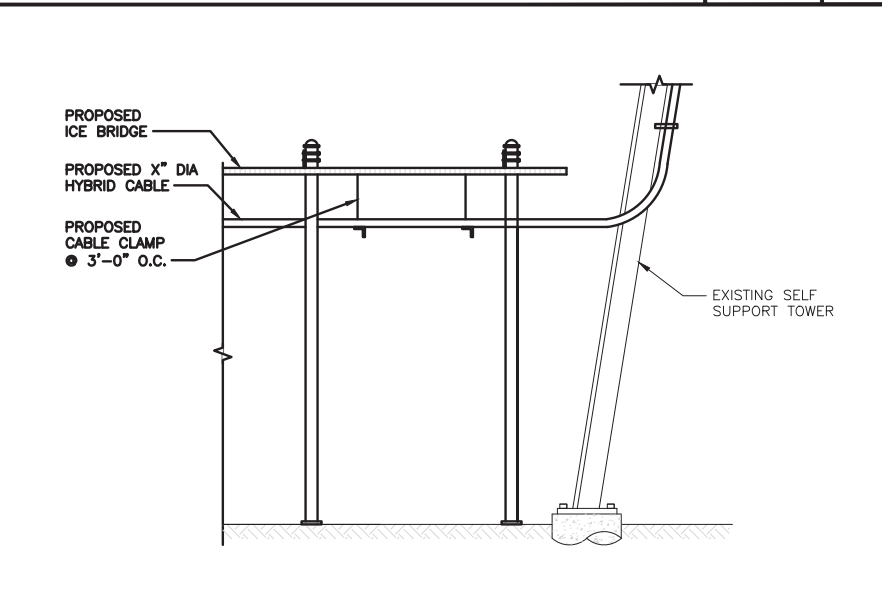

HYBRID CABLE RUN NO SCALE 9

5701 SOUTH SANTA FE DRIVE
LITTLETON, CO 80120

8051 CONGRESS AVENUE
BOCA RATON, FL 33487

1717 S. BOULDER
SUITE 300
TULSA, OK 74119
PH: (918) 587-4630
www.blgrp.com

B&T ENGINEERING, INC.

IT IS A VIOLATION OF LAW FOR ANY PERSON, UNLESS THEY ARE ACTING UNDER THE DIRECTION OF A LICENSED PROFESSIONAL ENGINEER, TO ALTER THIS DOCUMENT.

DRAWN BY:	CHECKED BY:	APPROVED BY:
RMC	BLJ	MDW
RFDS REV #:		0

PRELIMINARY DOCUMENTS

SUBMITTALS		
REV	DATE	DESCRIPTION
A	7/28/21	ISSUED FOR REVIEW
0	8/10/21	ISSUED FOR CONSTRUCTION

A&E PROJECT NUMBER
149562.001.01

DISH Wireless L.L.C.
PROJECT INFORMATION
BOBOS00593A
5 TOWN DUMP ROAD
TRURO, MA 02666

SHEET TITLE
EQUIPMENT DETAILS

SHEET NUMBER
A-4

PCTEL GPSGL-TMG-SPI-40NCB	
DIMENSIONS (DIAxH) MM/INCH	81x184mm 3.2"x7.25"
WEIGHT W/ACCESSORIES	075 lbs
CONNECTOR	N-FEMALE
FREQUENCY RANGE	1590 ± 30MHz



TOP

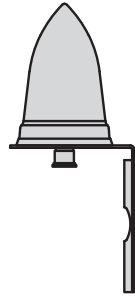

BACK

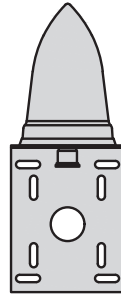

SIDE

GPS DETAIL

NO SCALE

1

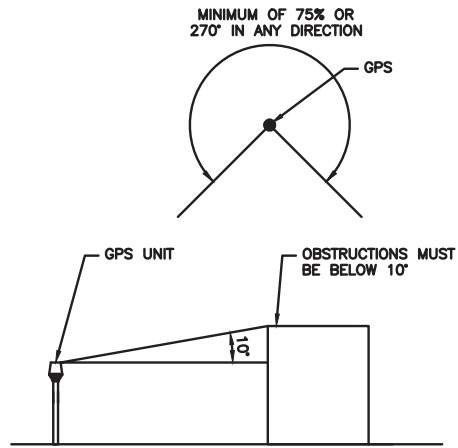

GPS MINIMUM SKY VIEW REQUIREMENTS

NO SCALE

2

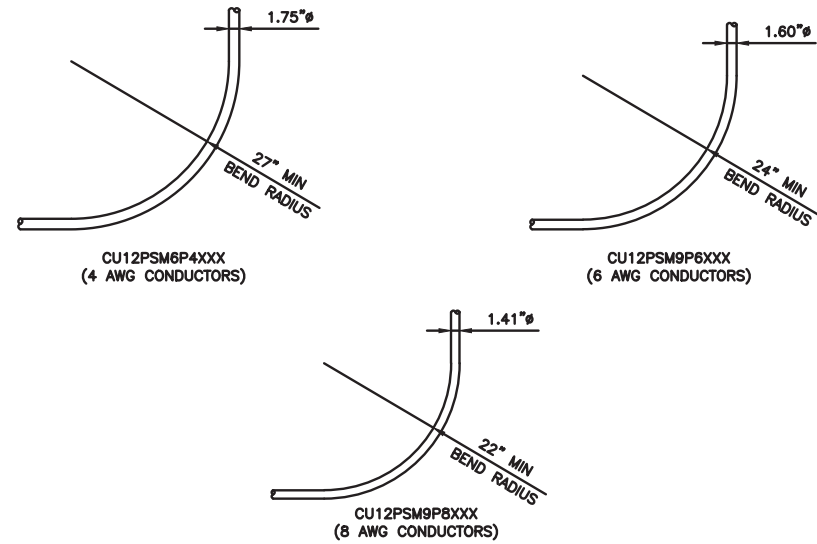

CABLES UNLIMITED HYBRID CABLE
MINIMUM BEND RADIUS

NO SCALE

3

NOT USED

NO SCALE

4

NOT USED

NO SCALE

5

NOT USED

NO SCALE

6

NOT USED

NO SCALE

7

NOT USED

NO SCALE

8

NOT USED

NO SCALE

9



5701 SOUTH SANTA FE DRIVE
LITTLETON, CO 80120



8051 CONGRESS AVENUE
BOCA RATON, FL 33487



1717 S. BOULDER
SUITE 300
TULSA, OK 74119
PH: (918) 587-4630
www.blgrp.com



B&T ENGINEERING, INC.

IT IS A VIOLATION OF LAW FOR ANY PERSON, UNLESS THEY ARE ACTING UNDER THE DIRECTION OF A LICENSED PROFESSIONAL ENGINEER, TO ALTER THIS DOCUMENT.

DRAWN BY: CHECKED BY: APPROVED BY:

RMC BLJ MDW

RFDS REV #: 0

PRELIMINARY DOCUMENTS

SUBMITTALS		
REV	DATE	DESCRIPTION
A	7/28/21	ISSUED FOR REVIEW
0	8/10/21	ISSUED FOR CONSTRUCTION

A&E PROJECT NUMBER
149562.001.01

DISH Wireless L.L.C.
PROJECT INFORMATION
BOBOS00593A
5 TOWN DUMP ROAD
TRURO, MA 02666

SHEET TITLE
EQUIPMENT DETAILS

SHEET NUMBER
A-5

FUJITSU TRIPLE BAND TA08025-B605	
DIMENSIONS (HxWxD)	14.9"x15.7"x9"
WEIGHT	74.95 lbs
CONNECTOR TYPE	4.3-10 RF CONNECTOR
POWER SUPPLY	DC -58~-36V

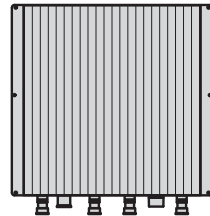
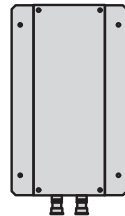
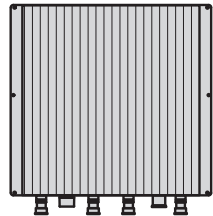
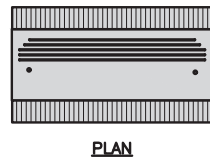

BACK

SIDE

FRONT

FUJITSU DUAL BAND TA08025-B604	
DIMENSIONS (HxWxD)	14.9"x15.7"x7.8"
WEIGHT	63.9 lbs
CONNECTOR TYPE	4.3-10 RF CONNECTOR
POWER SUPPLY	DC -58~-36V

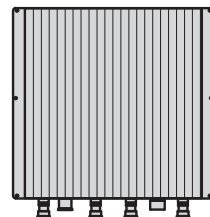
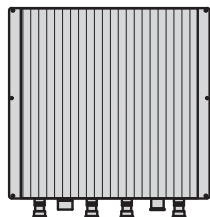
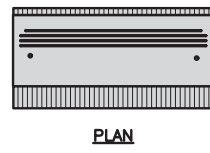

BACK

SIDE

FRONT

COMMSCOPE RR-FA2 LARGE STABILIZER	
DIMENSIONS (HxWxD)	16.4"x8.5"x18"
WEIGHT	39.2 lbs

DESIGN NOTES:
MOUNT WILL FIT LEGS UP TO:
- 5.6" ROUND
- 6.0" 60° ANGLE
- 4.5" 90° ANGLE

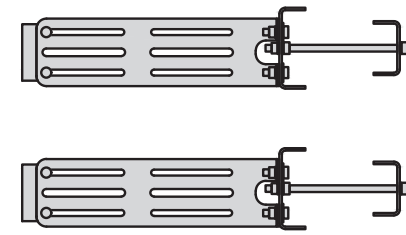

PLAN

SIDE

NOTE:
OR DISH Wireless L.L.C.
APPROVED EQUIVALENT

RRH DETAIL

NO SCALE

1

RRH DETAIL

NO SCALE

2

RRH MOUNT DETAIL

NO SCALE

3

RAYCAP RDIDC-9181-PF-48 DC SURGE PROTECTION (OVP)	
DIMENSIONS (HxWxD)	18.98"x14.39"x8.15"
WEIGHT	21.82 LBS

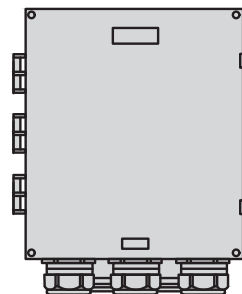
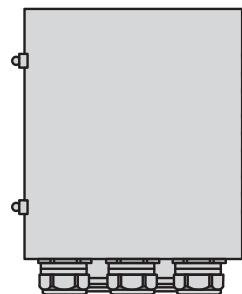
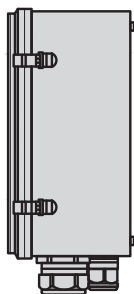

SIDE

BACK

FRONT

JMA MX08FRO665-21	
DIMENSIONS (HxWxD)	72"x20.0"x8.0"
RF PORTS, CONNECTOR TYPE	8 x 4.3-10 FEMALE
WEIGHT	64.5 lbs
WEIGHT WITH BRACKETS	82.5 lbs

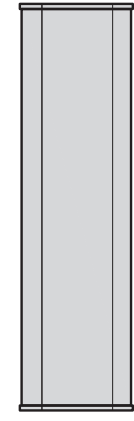
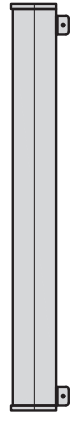

SIDE

FRONT

SURGE SUPPRESSION DETAIL (OVP)

NO SCALE

4

ANTENNA DETAIL

NO SCALE

5

NOT USED

NO SCALE

6

JMA ANTENNA MOUNT BRACKET #91900318	
TOTAL WEIGHT (WITH BRACKETS)	18 lbs (8.18 Kg)
POLE DIAMETER RANGE	2.5" TO 4.5"

NOTE:
KIT #91900318: TOP AND BOTTOM BRACKETS
FOR 4-, 6-, AND 8-FOOT ANTENNAS
ANTENNA BRACKET NOT PART OF KIT

NOTE:
OR DISH Wireless L.L.C.
APPROVED EQUIVALENT

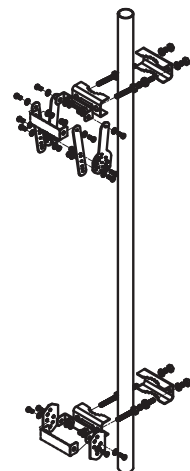

COMMSCOPE V-FRAME MTC3975083	
FACE SIZE	8'-0"
WEIGHT	352.136 lbs

NOTE:
OR DISH Wireless L.L.C.
APPROVED EQUIVALENT

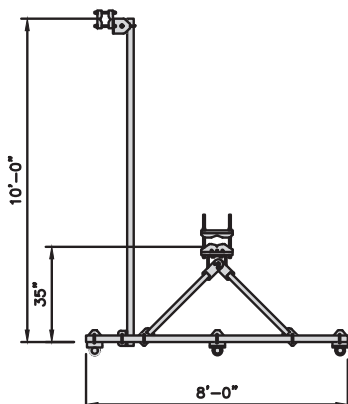

PLAN

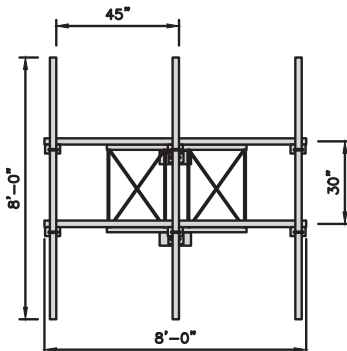

FRONT

ANTENNA BRACKET DETAIL

NO SCALE

7

ANTENNA FRAME DETAIL

NO SCALE

8

NOT USED

NO SCALE

9



5701 SOUTH SANTA FE DRIVE
LITTLETON, CO 80120



8051 CONGRESS AVENUE
BOCA RATON, FL 33487



1717 S. BOULDER
SUITE 300
TULSA, OK 74119
PH: (918) 587-4630
www.blgrp.com



B&T ENGINEERING, INC.

IT IS A VIOLATION OF LAW FOR ANY PERSON,
UNLESS THEY ARE ACTING UNDER THE DIRECTION
OF A LICENSED PROFESSIONAL ENGINEER,
TO ALTER THIS DOCUMENT.

DRAWN BY: CHECKED BY: APPROVED BY:

RMC BLJ MDW

RFDS REV #: 0

PRELIMINARY
DOCUMENTS

SUBMITTALS		
REV	DATE	DESCRIPTION
A	7/28/21	ISSUED FOR REVIEW
0	8/10/21	ISSUED FOR CONSTRUCTION

A&E PROJECT NUMBER
149562.001.01

DISH Wireless L.L.C.
PROJECT INFORMATION

BOBOS00593A
5 TOWN DUMP ROAD
TRURO, MA 02666

SHEET TITLE
EQUIPMENT DETAILS

SHEET NUMBER

A-6

FINAL POWER OR FIBER DESIGN
NOT AVAILABLE AT TIME OF ISSUE

NOTES

1. CONTRACTOR SHALL FIELD VERIFY ALL PROPOSED UNDERGROUND UTILITY CONDUIT ROUTE.
2. ANTENNAS AND MOUNTS OMITTED FOR CLARITY.

DC POWER WIRING SHALL BE COLOR CODED AT EACH END FOR IDENTIFYING +24V AND -48V CONDUCTORS. RED MARKINGS SHALL IDENTIFY +24V AND BLUE MARKINGS SHALL IDENTIFY -48V.

1. CONTRACTOR SHALL INSPECT THE EXISTING CONDITIONS PRIOR TO SUBMITTING A BID. ANY QUESTIONS ARISING DURING THE BID PERIOD IN REGARDS TO THE CONTRACTOR'S FUNCTIONS, THE SCOPE OF WORK, OR ANY OTHER ISSUE RELATED TO THIS PROJECT SHALL BE BROUGHT UP DURING THE BID PERIOD WITH THE PROJECT MANAGER FOR CLARIFICATION, NOT AFTER THE CONTRACT HAS BEEN AWARDED.
2. ALL ELECTRICAL WORK SHALL BE DONE IN ACCORDANCE WITH CURRENT NATIONAL ELECTRICAL CODES AND ALL STATE AND LOCAL CODES, LAWS, AND ORDINANCES. PROVIDE ALL COMPONENTS AND WIRING SIZES AS REQUIRED TO MEET NEC STANDARDS.
3. LOCATION OF EQUIPMENT, CONDUIT AND DEVICES SHOWN ON THE DRAWINGS ARE APPROXIMATE AND SHALL BE COORDINATED WITH FIELD CONDITIONS PRIOR TO CONSTRUCTION.
4. CONDUIT ROUGH-IN SHALL BE COORDINATED WITH THE MECHANICAL EQUIPMENT TO AVOID LOCATION CONFLICTS. VERIFY WITH THE MECHANICAL EQUIPMENT CONTRACTOR AND COMPLY AS REQUIRED.
5. CONTRACTOR SHALL PROVIDE ALL BREAKERS, CONDUITS AND CIRCUITS AS REQUIRED FOR A COMPLETE SYSTEM.
6. CONTRACTOR SHALL PROVIDE PULL BOXES AND JUNCTION BOXES AS REQUIRED BY THE NEC ARTICLE 314.
7. CONTRACTOR SHALL PROVIDE ALL STRAIN RELIEF AND CABLE SUPPORTS FOR ALL CABLE ASSEMBLIES. INSTALLATION SHALL BE IN ACCORDANCE WITH MANUFACTURER'S SPECIFICATIONS AND RECOMMENDATIONS.
8. ALL DISCONNECTS AND CONTROLLING DEVICES SHALL BE PROVIDED WITH ENGRAVED PHENOLIC NAMEPLATES INDICATING EQUIPMENT CONTROLLED, BRANCH CIRCUITS INSTALLED ON, AND PANEL FIELD LOCATIONS FED FROM.
9. INSTALL AN EQUIPMENT GROUNDING CONDUCTOR IN ALL CONDUITS PER THE SPECIFICATIONS AND NEC 250. THE EQUIPMENT GROUNDING CONDUCTORS SHALL BE BONDED AT ALL JUNCTION BOXES, PULL BOXES, AND ALL DISCONNECT SWITCHES, AND EQUIPMENT CABINETS.
10. ALL NEW MATERIAL SHALL HAVE A U.L. LABEL.
11. PANEL SCHEDULE LOADING AND CIRCUIT ARRANGEMENTS REFLECT POST-CONSTRUCTION EQUIPMENT.
12. CONTRACTOR SHALL BE RESPONSIBLE FOR AS-BUILT PANEL SCHEDULE AND SITE DRAWINGS.
13. ALL TRENCHES IN COMPOUND TO BE HAND DUG

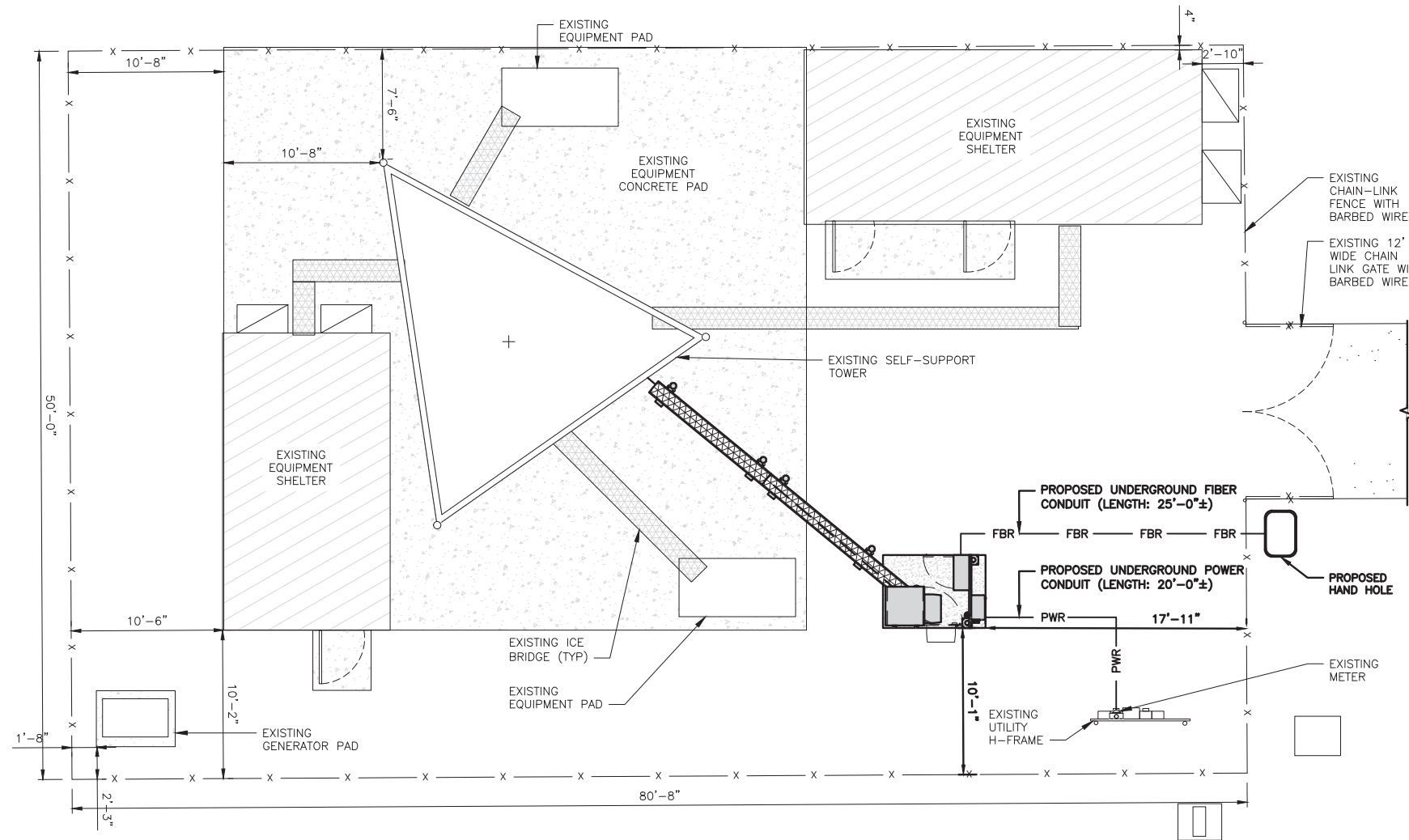

UTILITY ROUTE PLAN

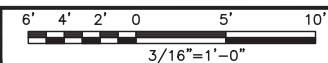

1

ELECTRICAL NOTES

NO SCALE

2



5701 SOUTH SANTA FE DRIVE
LITTLETON, CO 80120



8051 CONGRESS AVENUE
BOCA RATON, FL 33487



1717 S. BOULDER
SUITE 300
TULSA, OK 74119
PH: (918) 587-4630
www.blgrp.com



B&T ENGINEERING, INC.

IT IS A VIOLATION OF LAW FOR ANY PERSON,
UNLESS THEY ARE ACTING UNDER THE DIRECTION
OF A LICENSED PROFESSIONAL ENGINEER,
TO ALTER THIS DOCUMENT.

DRAWN BY:	CHECKED BY:	APPROVED BY:
RMC	BLJ	MDW

RFDS REV #: 0

PRELIMINARY DOCUMENTS

SUBMITTALS		
REV	DATE	DESCRIPTION
A	7/28/21	ISSUED FOR REVIEW
0	8/10/21	ISSUED FOR CONSTRUCTION

A&E PROJECT NUMBER
149562.001.01

DISH Wireless L.L.C.
PROJECT INFORMATION
BOBOS00593A
5 TOWN DUMP ROAD
TRURO, MA 02666

SHEET TITLE
**ELECTRICAL/FIBER ROUTE
PLAN AND NOTES**

SHEET NUMBER
E-1

CARLON EXPANSION FITTINGS				
COUPLING END PART#	MALE TERMINAL ADAPTER END PART#	SIZE	STD CTN QTY.	TRAVEL LENGTH
E945D	E945DX	1/2"	20	4"
E945E	E945EX	3/4"	15	4"
E945F	E945FX	1"	10	4"
E945G	E945GX	1 1/4"	5	4"
E945H	E945HX	1 1/2"	5	4"
E945J	E945JX	2"	15	8"
E945K	E945KX	2 1/2"	10	8"
E945L	E945LX	3"	10	8"
E945M	E945MX	3 1/2"	5	8"
E945N	E945NX	4"	5	8"
E945P	E945PX	5"	1	8"
E945R	E945RX	6"	1	8"

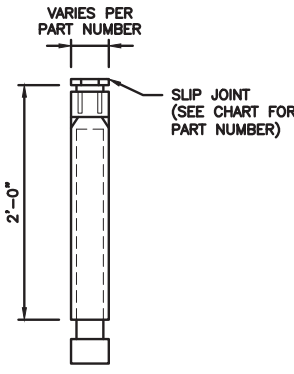

NOTE: CONTRACTOR TO INSTALL EXPANSION FITTING SLIP JOINT AT METER CENTER CONDUIT TERMINATION, AS PER LOCAL UTILITY POLICY, ORDINANCE AND/OR SPECIFIED REQUIREMENT.

TRENCHING NOTES

- CONTRACTOR SHALL RESTORE THE TRENCH TO ITS ORIGINAL CONDITIONS BY EITHER SEEDING OR SODDING GRASS AREAS, OR REPLACING ASPHALT OR CONCRETE AREAS TO ITS ORIGINAL CROSS SECTION.
- TRENCHING SAFETY; INCLUDING, BUT NOT LIMITED TO SOIL CLASSIFICATION, SLOPING, AND SHORING, SHALL BE GOVERNED BY THE CURRENT OSHA TRENCHING AND EXCAVATION SAFETY STANDARDS.
- ALL CONDUITS SHALL BE INSTALLED IN COMPLIANCE WITH THE CURRENT NATIONAL ELECTRIC CODE (NEC) OR AS REQUIRED BY THE LOCAL JURISDICTION, WHICHEVER IS THE MOST STRINGENT.

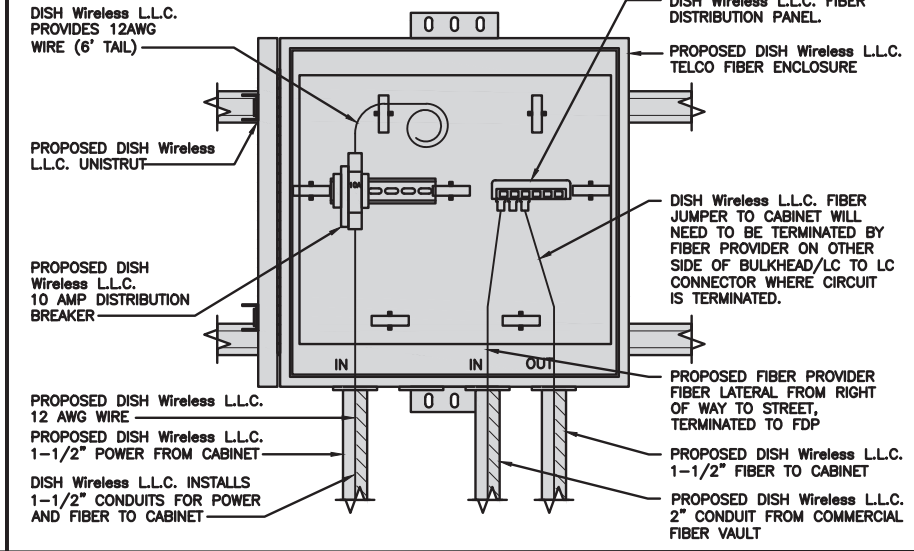
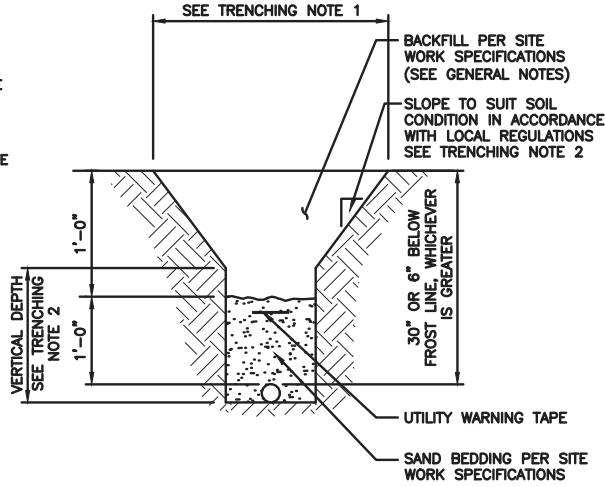

EXPANSION JOINT DETAIL

NO SCALE 1

TYPICAL UNDERGROUND TRENCH DETAIL

NO SCALE 2

DARK TELCO BOX – INTERIOR WIRING LAYOUT

NO SCALE 3

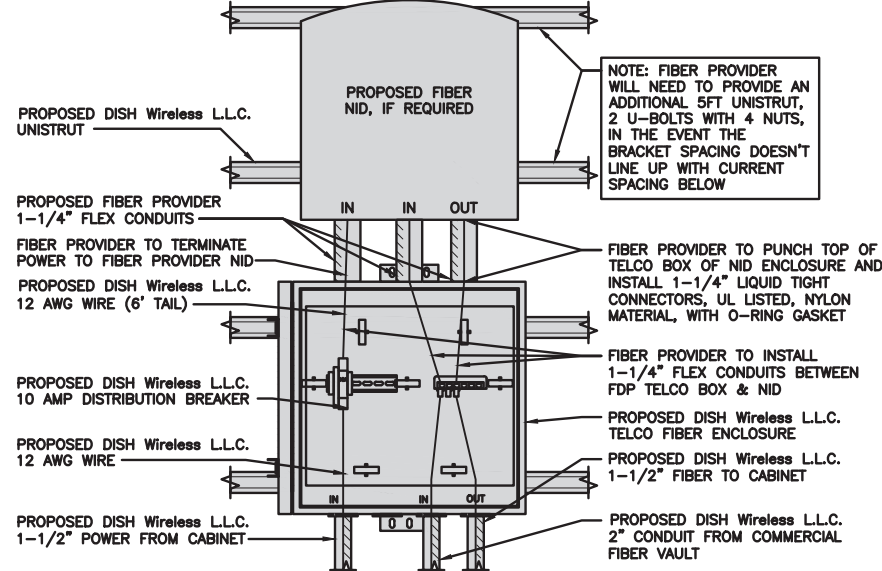

LIT TELCO BOX – INTERIOR WIRING LAYOUT (OPTIONAL)

NO SCALE 4

NOT USED

NO SCALE 5

NOT USED

NO SCALE 6

NOT USED

NO SCALE 7

NOT USED

NO SCALE 8

NOT USED

NO SCALE 9



5701 SOUTH SANTA FE DRIVE
LITTLETON, CO 80120



8051 CONGRESS AVENUE
BOCA RATON, FL 33487



B&T ENGINEERING, INC.

IT IS A VIOLATION OF LAW FOR ANY PERSON, UNLESS THEY ARE ACTING UNDER THE DIRECTION OF A LICENSED PROFESSIONAL ENGINEER, TO ALTER THIS DOCUMENT.

DRAWN BY:	CHECKED BY:	APPROVED BY:
RMC	BLJ	MDW
RFDS REV #:		0

PRELIMINARY DOCUMENTS

SUBMITTALS		
REV	DATE	DESCRIPTION
A	7/28/21	ISSUED FOR REVIEW
0	8/10/21	ISSUED FOR CONSTRUCTION

A&E PROJECT NUMBER
149562.001.01

DISH Wireless L.L.C.
PROJECT INFORMATION

BOBOS00593A
5 TOWN DUMP ROAD
TRURO, MA 02666

SHEET TITLE
ELECTRICAL
DETAILS

SHEET NUMBER

E-2

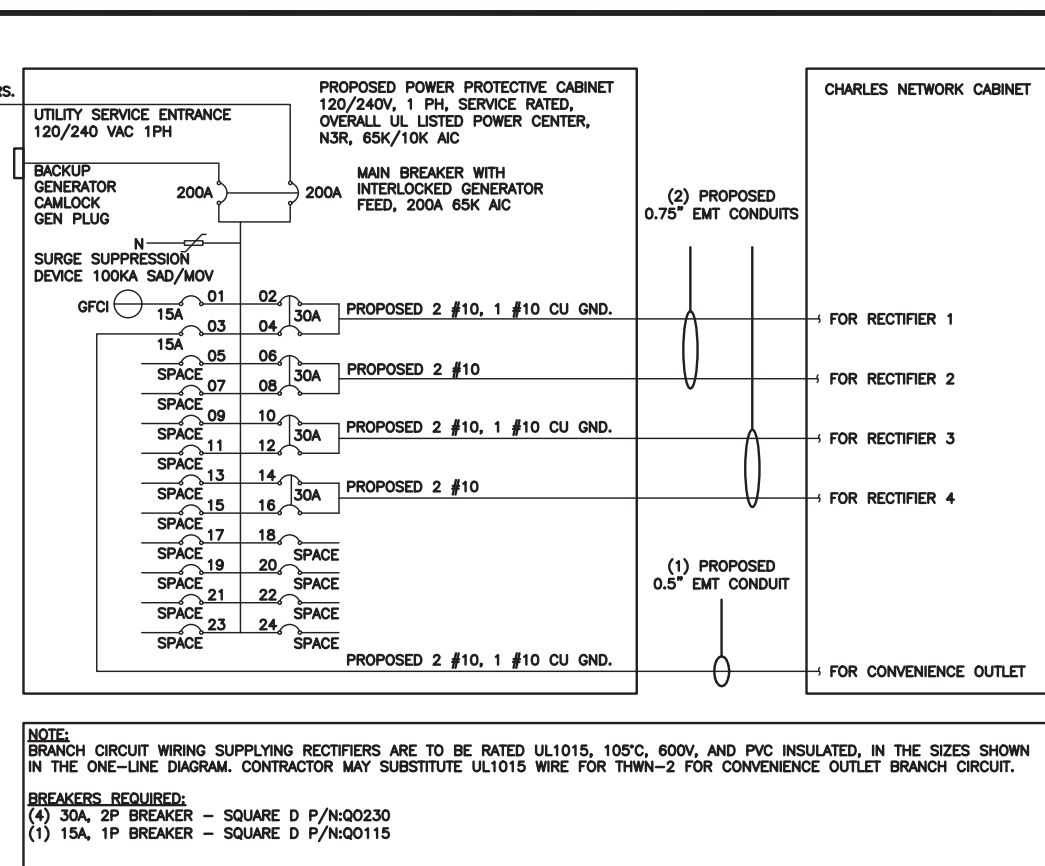
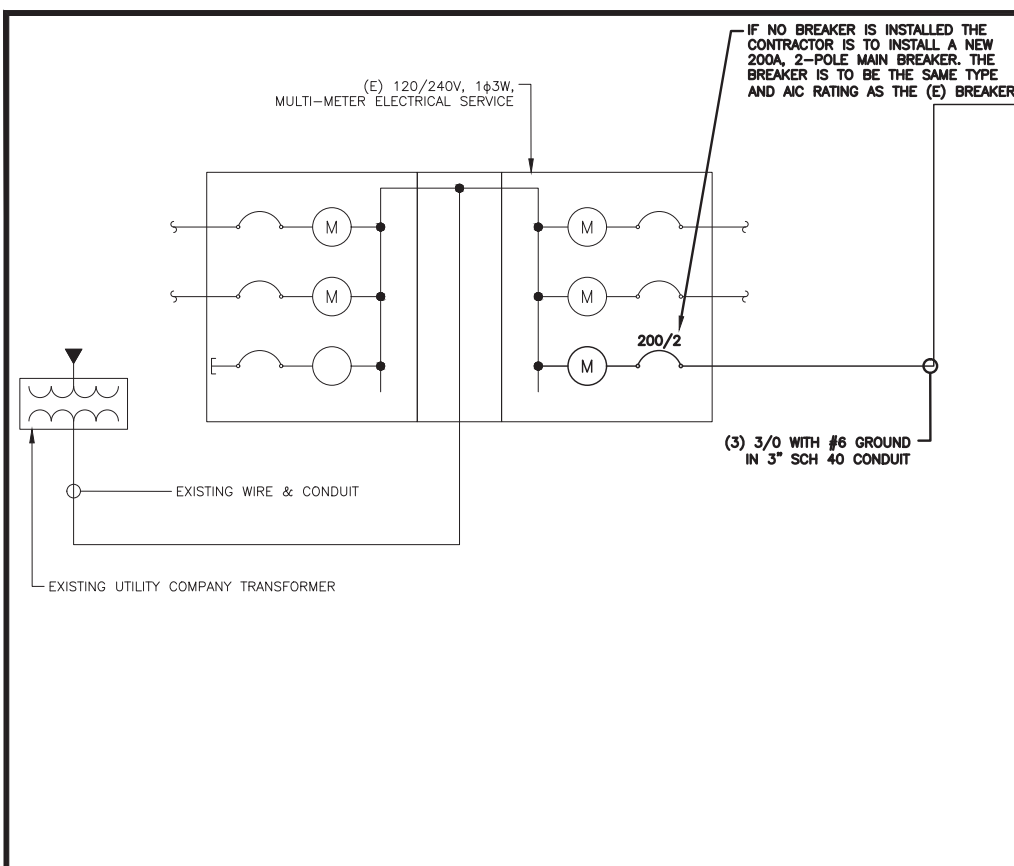

NOTES

THE (2) CONDUITS WITH (4) CURRENT CARRYING CONDUCTORS EACH, SHALL APPLY THE ADJUSTMENT FACTOR OF 80% PER 2014/17 NEC TABLE 310.15(B)(3)(g) OR 2020 NEC TABLE 310.15(C)(1) FOR UL1015 WIRE.

#12 FOR 15A-20A/1P BREAKER: 0.8 x 30A = 24.0A
#10 FOR 25A-30A/2P BREAKER: 0.8 x 40A = 32.0A
#8 FOR 35A-40A/2P BREAKER: 0.8 x 55A = 44.0A
#6 FOR 45A-60A/2P BREAKER: 0.8 x 75A = 60.0A

CONDUIT SIZING: AT 40% FILL PER NEC CHAPTER 9, TABLE 4, ARTICLE 358.
0.5" CONDUIT - 0.122 SQ. IN AREA
0.75" CONDUIT - 0.213 SQ. IN AREA
2.0" CONDUIT - 1.316 SQ. IN AREA
3.0" CONDUIT - 2.907 SQ. IN AREA

CABINET CONVENIENCE OUTLET CONDUCTORS (1 CONDUIT): USING THWN-2, CU.
#10 - 0.0211 SQ. IN X 2 = 0.0422 SQ. IN
#10 - 0.0211 SQ. IN X 1 = 0.0211 SQ. IN <GROUND
TOTAL = 0.0633 SQ. IN

0.5" EMT CONDUIT IS ADEQUATE TO HANDLE THE TOTAL OF (3) WIRES, INCLUDING GROUND WIRE, AS INDICATED ABOVE.

RECTIFIER CONDUCTORS (2 CONDUITS): USING UL1015, CU.
#10 - 0.0266 SQ. IN X 4 = 0.1064 SQ. IN
#10 - 0.0082 SQ. IN X 1 = 0.0082 SQ. IN <BARE GROUND
TOTAL = 0.1146 SQ. IN

0.75" EMT CONDUIT IS ADEQUATE TO HANDLE THE TOTAL OF (5) WIRES, INCLUDING GROUND WIRE, AS INDICATED ABOVE.

PPC FEED CONDUCTORS (1 CONDUIT): USING THWN, CU.
3/0 - 0.2679 SQ. IN X 3 = 0.8037 SQ. IN
#6 - 0.0507 SQ. IN X 1 = 0.0507 SQ. IN <GROUND
TOTAL = 0.8544 SQ. IN

3.0" SCH 40 PVC CONDUIT IS ADEQUATE TO HANDLE THE TOTAL OF (4) WIRES, INCLUDING GROUND WIRE, AS INDICATED ABOVE.

PPC ONE-LINE DIAGRAM

NO SCALE 1

PROPOSED CHARLES PANEL SCHEDULE

LOAD SERVED	VOLT AMPS (WATTS)		TRIP	CKT #	PHASE	CKT #	TRIP	VOLT AMPS (WATTS)		LOAD SERVED
	L1	L2						L1	L2	
PPC GFCI OUTLET	180	180	15A	1	A	2	30A	2880	2880	ABB/GE INFINITY RECTIFIER 1
CHARLES GFCI OUTLET	180	180	15A	3	B	4	30A	2880	2880	ABB/GE INFINITY RECTIFIER 1
-SPACE-				5	A	6	30A	2880	2880	ABB/GE INFINITY RECTIFIER 2
-SPACE-				7	B	8	30A	2880	2880	ABB/GE INFINITY RECTIFIER 2
-SPACE-				9	A	10	30A	2880	2880	ABB/GE INFINITY RECTIFIER 3
-SPACE-				11	B	12	30A	2880	2880	ABB/GE INFINITY RECTIFIER 3
-SPACE-				13	A	14	30A	2880	2880	ABB/GE INFINITY RECTIFIER 4
-SPACE-				15	B	16	30A	2880	2880	ABB/GE INFINITY RECTIFIER 4
-SPACE-				17	A	18				-SPACE-
-SPACE-				19	B	20				-SPACE-
-SPACE-				21	A	22				-SPACE-
-SPACE-				23	B	24				-SPACE-
VOLTAGE AMPS			180	180				11520	11520	
200A MCB, 1 ϕ , 24 SPACE, 120/240V			L1		L2					
MB RATING: 65,000 AIC			11700	11700	VOLTAGE AMPS					
			98	98	AMPS					
			98		MAX AMPS					
			123		MAX 125%					

PANEL SCHEDULE

NO SCALE 2

NOT USED

NO SCALE 3



5701 SOUTH SANTA FE DRIVE
LITTLETON, CO 80120



8051 CONGRESS AVENUE
BOCA RATON, FL 33487



B&T ENGINEERING, INC.

IT IS A VIOLATION OF LAW FOR ANY PERSON, UNLESS THEY ARE ACTING UNDER THE DIRECTION OF A LICENSED PROFESSIONAL ENGINEER, TO ALTER THIS DOCUMENT.

DRAWN BY:	CHECKED BY:	APPROVED BY:
RMC	BLJ	MDW

RFDS REV #: 0

PRELIMINARY DOCUMENTS

SUBMITTALS		
REV	DATE	DESCRIPTION
A	7/28/21	ISSUED FOR REVIEW
0	8/10/21	ISSUED FOR CONSTRUCTION

A&E PROJECT NUMBER
149562.001.01

DISH Wireless L.L.C.
PROJECT INFORMATION
BOBOS00593A
5 TOWN DUMP ROAD
TRURO, MA 02666

SHEET TITLE
ELECTRICAL ONE-LINE, FAULT
CALCS & PANEL SCHEDULE

SHEET NUMBER
E-3

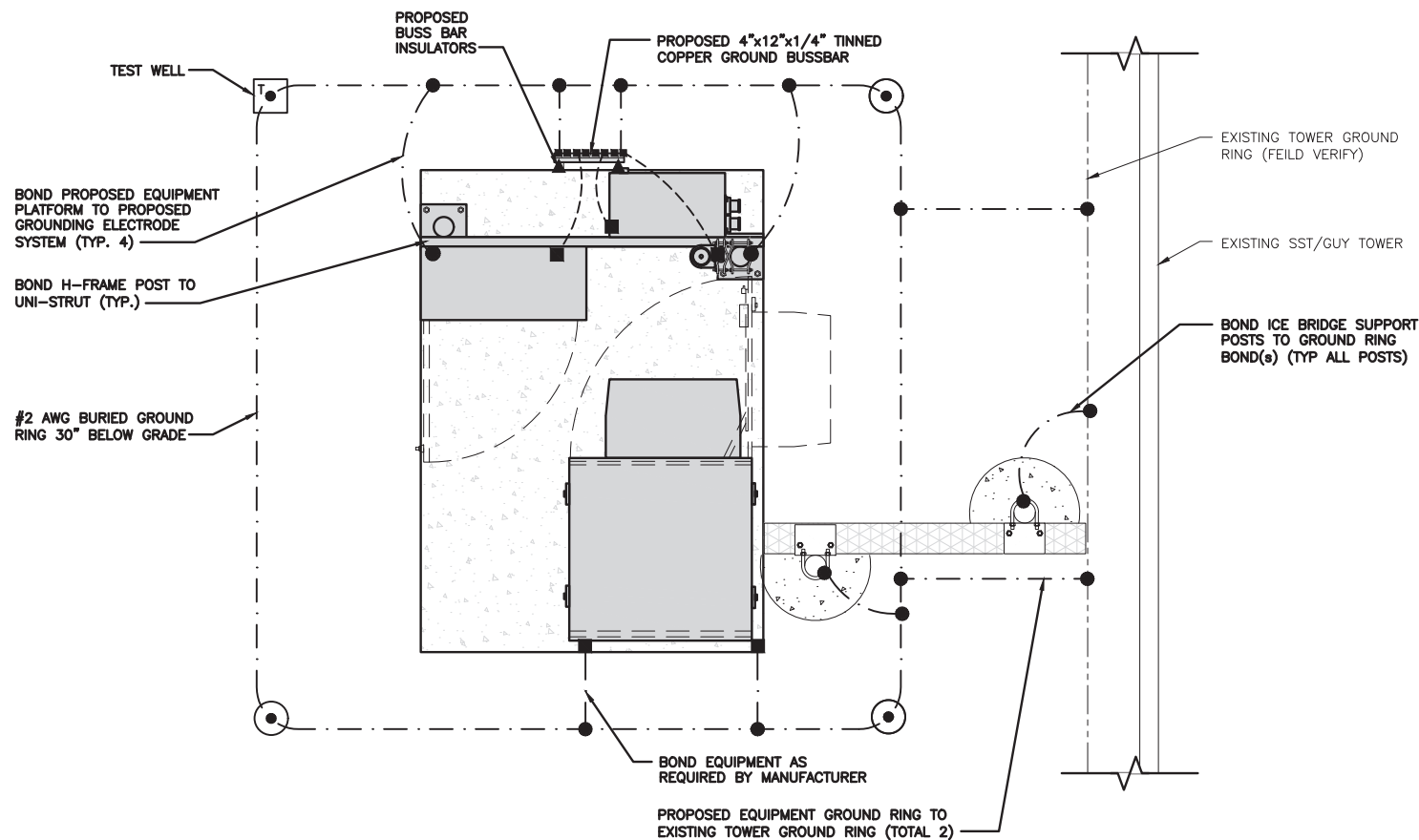

TYPICAL EQUIPMENT GROUNDING PLAN

NO SCALE 1

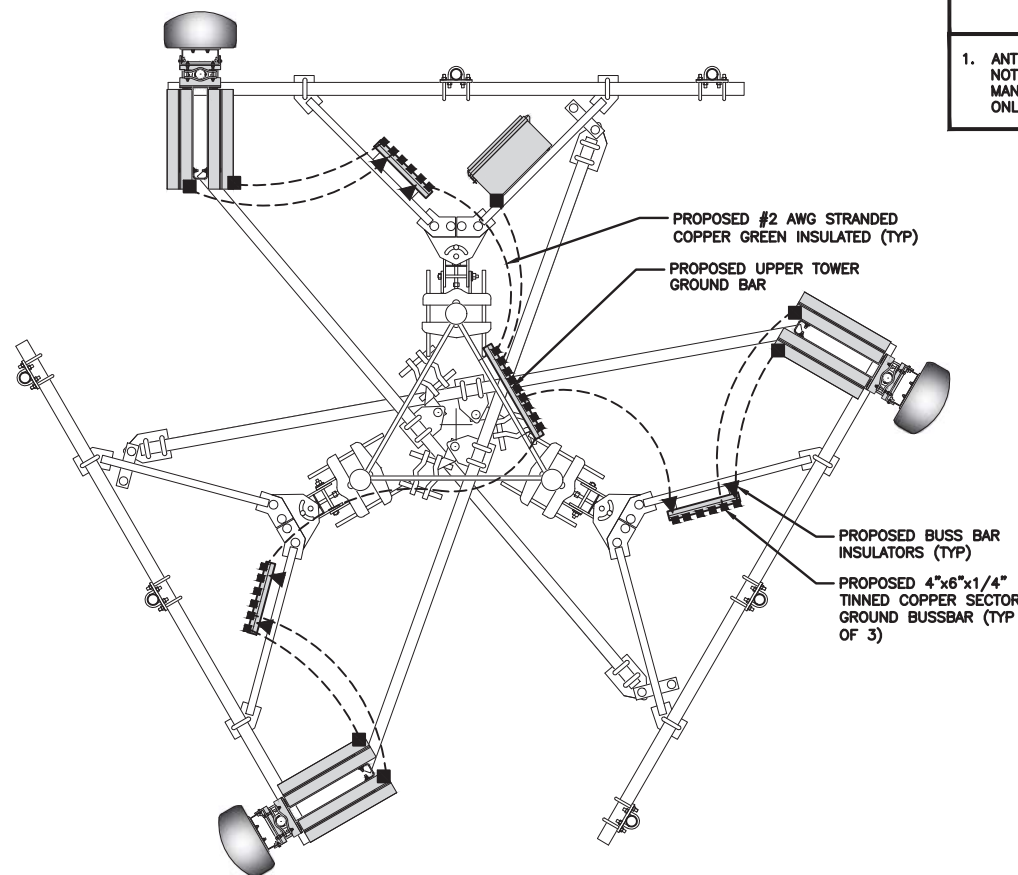

TYPICAL ANTENNA GROUNDING PLAN

NO SCALE 2

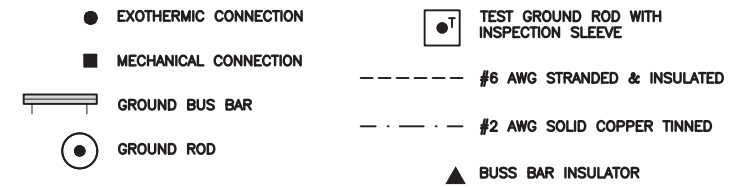

GROUNDING LEGEND

- GROUNDING IS SHOWN DIAGRAMMATICALLY ONLY.
- CONTRACTOR SHALL GROUND ALL EQUIPMENT AS A COMPLETE SYSTEM. GROUNDING SHALL BE IN COMPLIANCE WITH NEC SECTION 250 AND DISH Wireless L.L.C. GROUNDING AND BONDING REQUIREMENTS AND MANUFACTURER'S SPECIFICATIONS.
- ALL GROUND CONDUCTORS SHALL BE COPPER; NO ALUMINUM CONDUCTORS SHALL BE USED.

GROUNDING KEY NOTES

- (A) **EXTERIOR GROUND RING:** #2 AWG SOLID COPPER, BURIED AT A DEPTH OF AT LEAST 30 INCHES BELOW GRADE, OR 6 INCHES BELOW THE FROST LINE AND APPROXIMATELY 24 INCHES FROM THE EXTERIOR WALL OR FOOTING.
- (B) **TOWER GROUND RING:** THE GROUND RING SYSTEM SHALL BE INSTALLED AROUND AN ANTENNA TOWER'S LEGS, AND/OR GUY ANCHORS. WHERE SEPARATE SYSTEMS HAVE BEEN PROVIDED FOR THE TOWER AND THE BUILDING, AT LEAST TWO BONDS SHALL BE MADE BETWEEN THE TOWER RING GROUND SYSTEM AND THE BUILDING RING GROUND SYSTEM USING MINIMUM #2 AWG SOLID COPPER CONDUCTORS.
- (C) **INTERIOR GROUND RING:** #2 AWG STRANDED GREEN INSULATED COPPER CONDUCTOR EXTENDED AROUND THE PERIMETER OF THE EQUIPMENT AREA. ALL NON-TELECOMMUNICATIONS RELATED METALLIC OBJECTS FOUND WITHIN A SITE SHALL BE GROUNDED TO THE INTERIOR GROUND RING WITH #6 AWG STRANDED GREEN INSULATED CONDUCTOR.
- (D) **BOND TO INTERIOR GROUND RING:** #2 AWG SOLID TINNED COPPER WIRE PRIMARY BONDS SHALL BE PROVIDED AT LEAST AT FOUR POINTS ON THE INTERIOR GROUND RING, LOCATED AT THE CORNERS OF THE BUILDING.
- (E) **GROUND ROD:** UL LISTED COPPER CLAD STEEL MINIMUM 1/2" DIAMETER BY EIGHT FEET LONG. GROUND RODS SHALL BE INSTALLED WITH INSPECTION SLEEVES. GROUND RODS SHALL BE DRIVEN TO THE DEPTH OF GROUND RING CONDUCTOR.
- (F) **CELL REFERENCE GROUND BAR:** POINT OF GROUND REFERENCE FOR ALL COMMUNICATIONS EQUIPMENT FRAMES. ALL BONDS ARE MADE WITH #2 AWG UNLESS NOTED OTHERWISE STRANDED GREEN INSULATED COPPER CONDUCTORS. BOND TO GROUND RING WITH (2) #2 SOLID TINNED COPPER CONDUCTORS.
- (G) **HATCH PLATE GROUND BAR:** BOND TO THE INTERIOR GROUND RING WITH TWO #2 AWG STRANDED GREEN INSULATED COPPER CONDUCTORS. WHEN A HATCH-PLATE AND A CELL REFERENCE GROUND BAR ARE BOTH PRESENT, THE CRGB MUST BE CONNECTED TO THE HATCH-PLATE AND TO THE INTERIOR GROUND RING USING (2) TWO #2 AWG STRANDED GREEN INSULATED COPPER CONDUCTORS EACH.
- (H) **EXTERIOR CABLE ENTRY PORT GROUND BARS:** LOCATED AT THE ENTRANCE TO THE CELL SITE BUILDING. BOND TO GROUND RING WITH A #2 AWG SOLID TINNED COPPER CONDUCTORS WITH AN EXOTHERMIC WELD AND INSPECTION SLEEVE.
- (I) **TELCO GROUND BAR:** BOND TO BOTH CELL REFERENCE GROUND BAR OR EXTERIOR GROUND RING.
- (J) **FRAME BONDING:** THE BONDING POINT FOR TELECOM EQUIPMENT FRAMES SHALL BE THE GROUND BUS THAT IS NOT ISOLATED FROM THE EQUIPMENTS METAL FRAMEWORK.
- (K) **INTERIOR UNIT BONDS:** METAL FRAMES, CABINETS AND INDIVIDUAL METALLIC UNITS LOCATED WITH THE AREA OF THE INTERIOR GROUND RING REQUIRE A #6 AWG STRANDED GREEN INSULATED COPPER BOND TO THE INTERIOR GROUND RING.
- (L) **FENCE AND GATE GROUNDING:** METAL FENCES WITHIN 7 FEET OF THE EXTERIOR GROUND RING OR OBJECTS BONDED TO THE EXTERIOR GROUND RING SHALL BE BONDED TO THE GROUND RING WITH A #2 AWG SOLID TINNED COPPER CONDUCTOR AT AN INTERVAL NOT EXCEEDING 25 FEET. BONDS SHALL BE MADE AT EACH GATE POST AND ACROSS GATE OPENINGS.
- (M) **EXTERIOR UNIT BONDS:** METALLIC OBJECTS, EXTERNAL TO OR MOUNTED TO THE BUILDING, SHALL BE BONDED TO THE EXTERIOR GROUND RING. USING #2 TINNED SOLID COPPER WIRE
- (N) **ICE BRIDGE SUPPORTS:** EACH ICE BRIDGE LEG SHALL BE BONDED TO THE GROUND RING WITH #2 AWG BARE TINNED COPPER CONDUCTOR. PROVIDE EXOTHERMIC WELDS AT BOTH THE ICE BRIDGE LEG AND BURIED GROUND RING.
- (O) DURING ALL DC POWER SYSTEM CHANGES INCLUDING DC SYSTEM CHANGE OUTS, RECTIFIER REPLACEMENTS OR ADDITIONS, BREAKER DISTRIBUTION CHANGES, BATTERY ADDITIONS, BATTERY REPLACEMENTS AND INSTALLATIONS OR CHANGES TO DC CONVERTER SYSTEMS IT SHALL BE REQUIRED THAT SERVICE CONTRACTORS VERIFY ALL DC POWER SYSTEMS ARE EQUIPPED WITH A MASTER DC SYSTEM RETURN GROUND CONDUCTOR FROM THE DC POWER SYSTEM COMMON RETURN BUS DIRECTLY CONNECTED TO THE CELL SITE REFERENCE GROUND BAR
- (P) TOWER TOP COLLECTOR BUSS BAR IS TO BE MECHANICALLY BONDED TO TOWER STEEL.
REFER TO DISH Wireless L.L.C. GROUNDING NOTES.

GROUNDING KEY NOTES

NO SCALE 3



5701 SOUTH SANTA FE DRIVE
LITTLETON, CO 80120



8051 CONGRESS AVENUE
BOCA RATON, FL 33487



1717 S. BOULDER
SUITE 300
TULSA, OK 74119
PH: (918) 587-4630
www.btgrp.com



B&T ENGINEERING, INC.

IT IS A VIOLATION OF LAW FOR ANY PERSON, UNLESS THEY ARE ACTING UNDER THE DIRECTION OF A LICENSED PROFESSIONAL ENGINEER, TO ALTER THIS DOCUMENT.

DRAWN BY: CHECKED BY: APPROVED BY:

RMC BLJ MDW

RFDS REV #: 0

PRELIMINARY DOCUMENTS

SUBMITTALS		
REV	DATE	DESCRIPTION
A	7/28/21	ISSUED FOR REVIEW
0	8/10/21	ISSUED FOR CONSTRUCTION

A&E PROJECT NUMBER
149562.001.01

DISH Wireless L.L.C.
PROJECT INFORMATION

BOBOS00593A
5 TOWN DUMP ROAD
TRURO, MA 02666

SHEET TITLE
GROUNDING PLANS
AND NOTES

SHEET NUMBER

G-1

NOTES

EQUIPMENT CABINET OMITTED FOR CLARITY

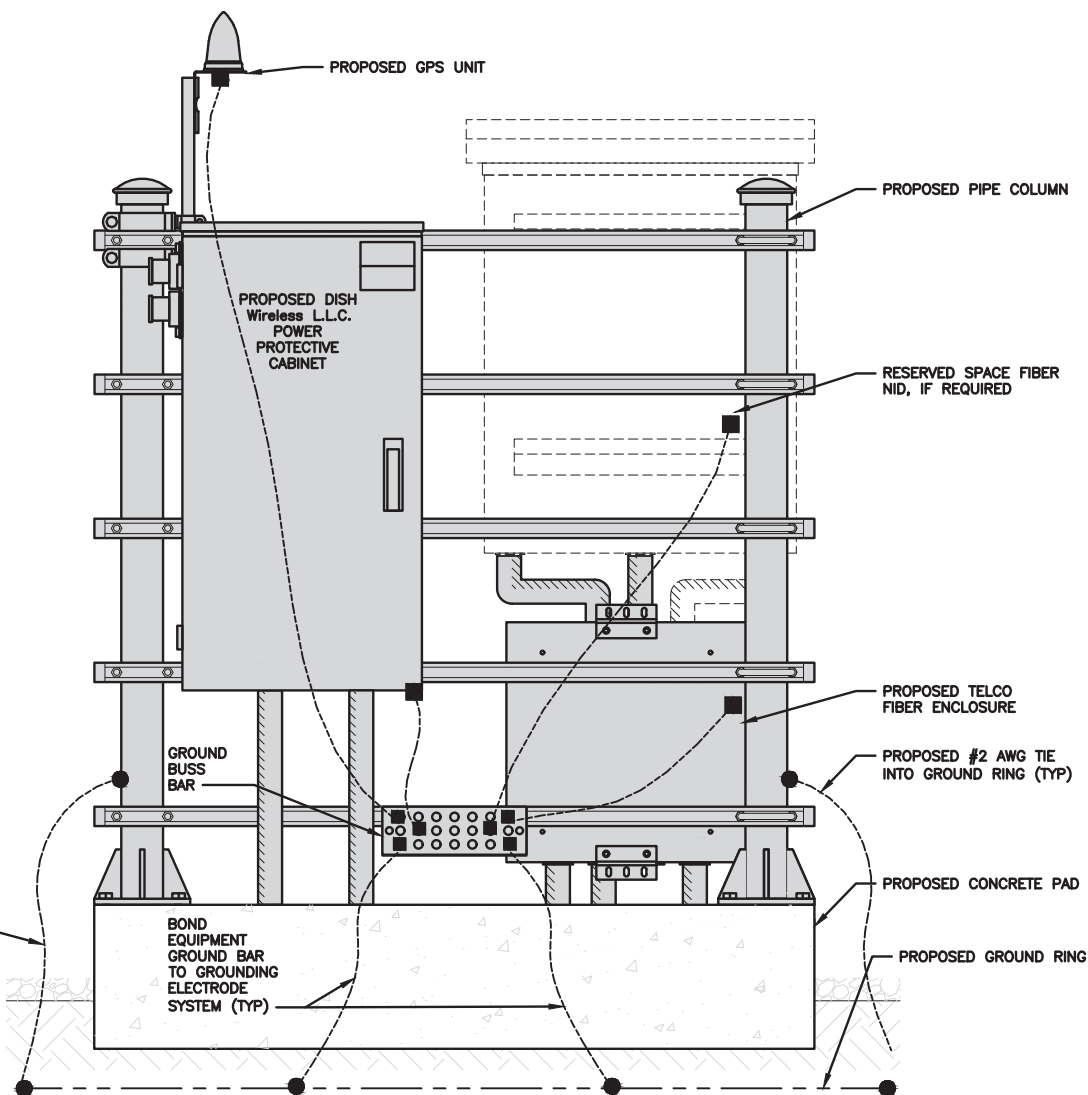

H-FRAME GROUNDING DETAIL

NO SCALE 1

NOTES

CABLE GROUNDING **NOT** REQUIRED WHEN ANTENNA IS LESS THAN 10' FROM CABINET

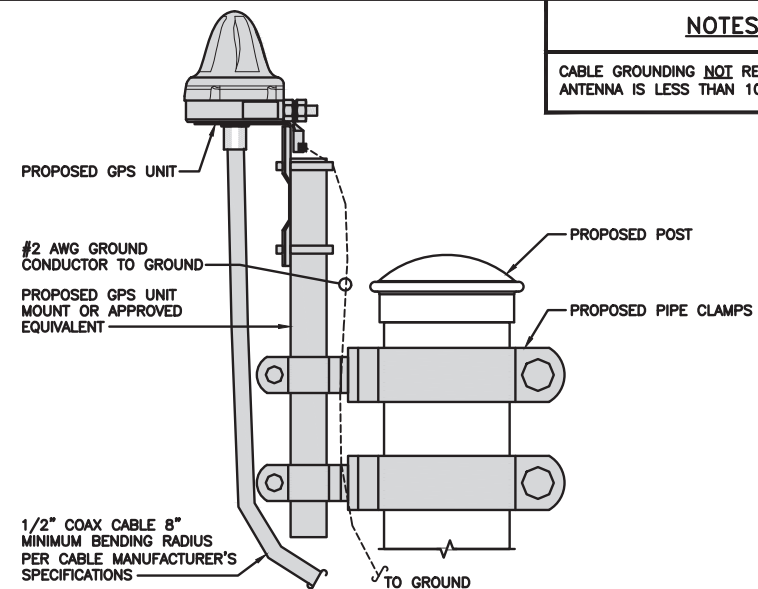

TYPICAL GPS UNIT GROUNDING

NO SCALE 2

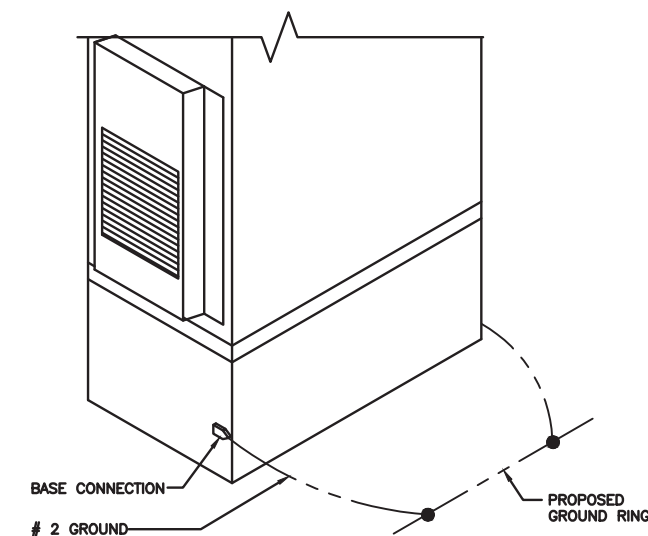

OUTDOOR CABINET GROUNDING

NO SCALE 3

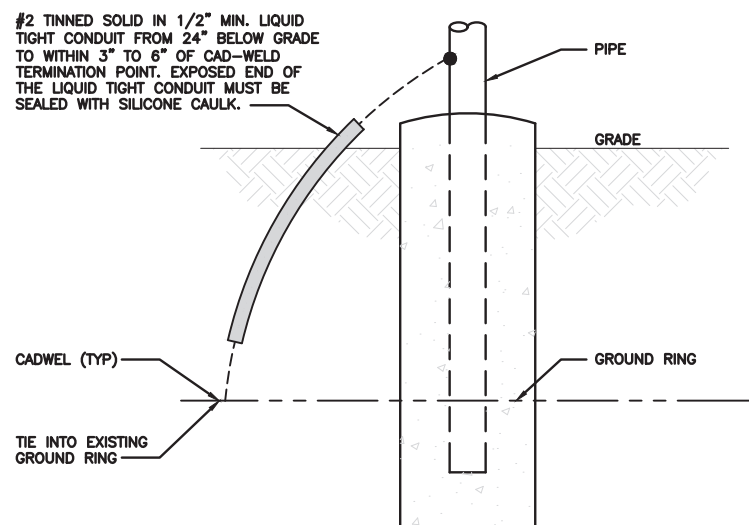

TRANSITIONING GROUND DETAIL

NO SCALE 4

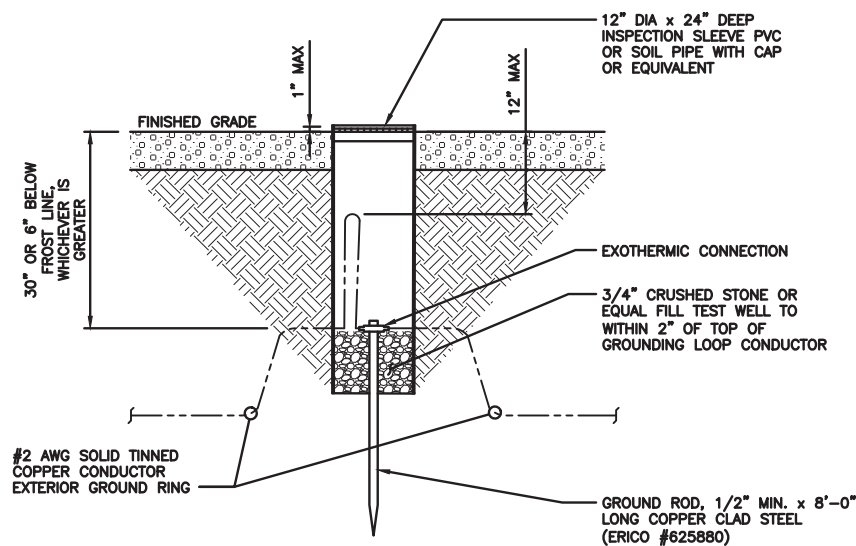

TYPICAL TEST GROUND ROD WITH INSPECTION SLEEVE

NO SCALE 5

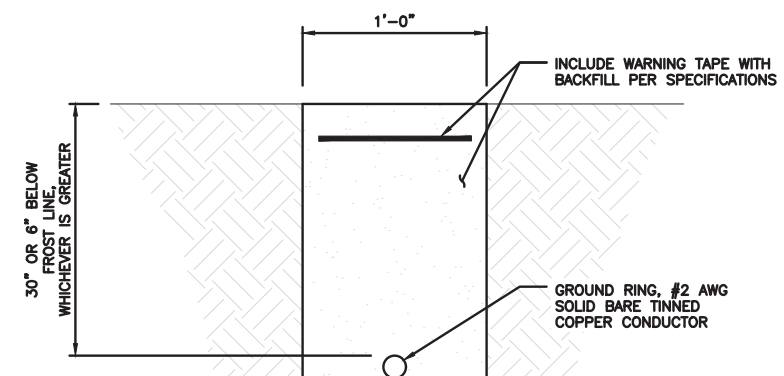

TYPICAL GROUND RING TRENCH

NO SCALE 6



5701 SOUTH SANTA FE DRIVE
LITTLETON, CO 80120



8051 CONGRESS AVENUE
BOCA RATON, FL 33487



1717 S. BOULDER
SUITE 300
TULSA, OK 74119
PH: (918) 587-4630
www.blgrp.com



B&T ENGINEERING, INC.

IT IS A VIOLATION OF LAW FOR ANY PERSON, UNLESS THEY ARE ACTING UNDER THE DIRECTION OF A LICENSED PROFESSIONAL ENGINEER, TO ALTER THIS DOCUMENT.

DRAWN BY: CHECKED BY: APPROVED BY:

RMC BLJ MDW

RFDS REV #: 0

PRELIMINARY DOCUMENTS

SUBMITTALS		
REV	DATE	DESCRIPTION
A	7/28/21	ISSUED FOR REVIEW
0	8/10/21	ISSUED FOR CONSTRUCTION

A&E PROJECT NUMBER
149562.001.01

DISH Wireless L.L.C.
PROJECT INFORMATION

BOBOS00593A
5 TOWN DUMP ROAD
TRURO, MA 02666

SHEET TITLE
GROUNDING DETAILS

SHEET NUMBER

G-2

1. EXOTHERMIC WELD (2) TWO, #2 AWG BARE TINNED SOLID COPPER CONDUCTORS TO GROUND BAR. ROUTE CONDUCTORS TO BURIED GROUND RING AND PROVIDE PARALLEL EXOTHERMIC WELD.
2. ALL EXTERIOR GROUNDING HARDWARE SHALL BE STAINLESS STEEL 3/8" DIAMETER OR LARGER. ALL HARDWARE 18-8 STAINLESS STEEL INCLUDING LOCK WASHERS, COAT ALL SURFACES WITH AN ANTI-OXIDANT COMPOUND BEFORE MATING.
3. FOR GROUND BOND TO STEEL ONLY: COAT ALL SURFACES WITH AN ANTI-OXIDANT COMPOUND BEFORE MATING.
4. DO NOT INSTALL CABLE GROUNDING KIT AT A BEND AND ALWAYS DIRECT GROUND CONDUCTOR DOWN TO GROUNDING BUS.
5. NUT & WASHER SHALL BE PLACED ON THE FRONT SIDE OF THE GROUND BAR AND BOLTED ON THE BACK SIDE.
6. ALL GROUNDING PARTS AND EQUIPMENT TO BE SUPPLIED AND INSTALLED BY CONTRACTOR.
7. THE CONTRACTOR SHALL BE RESPONSIBLE FOR INSTALLING ADDITIONAL GROUND BAR AS REQUIRED.
8. ENSURE THE WIRE INSULATION TERMINATION IS WITHIN 1/8" OF THE BARREL (NO SHINERS).

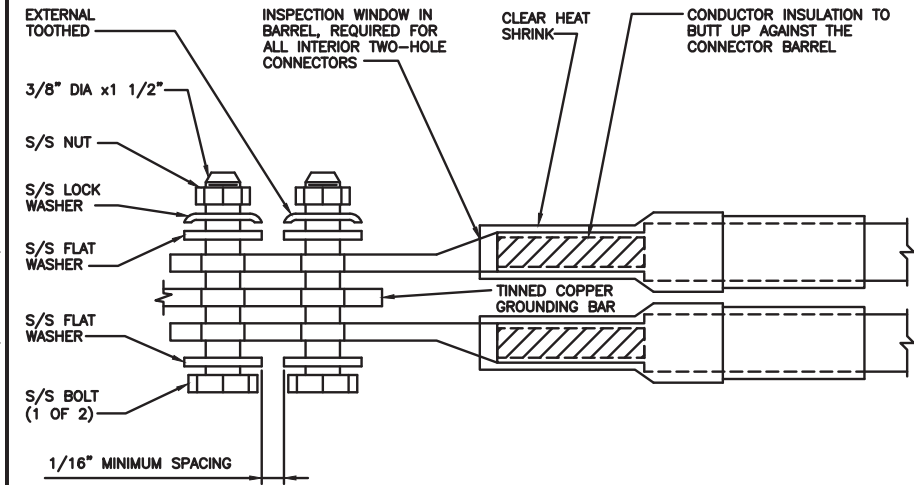
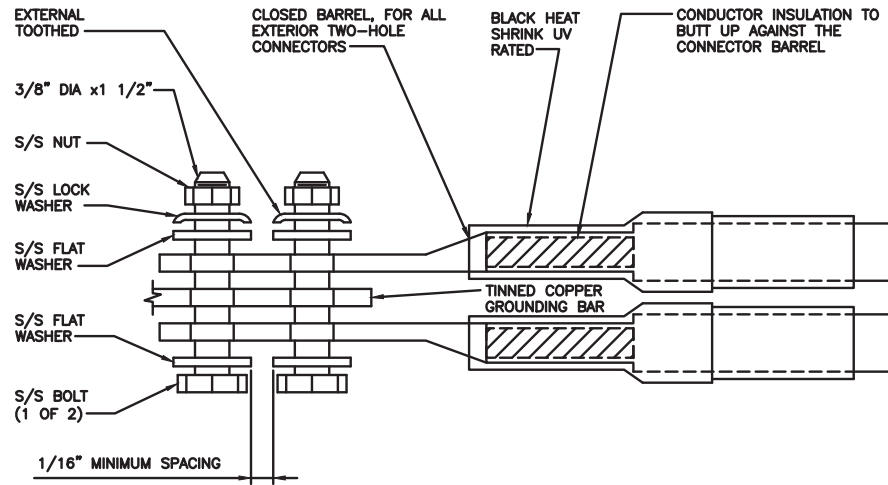

TYPICAL GROUNDING NOTES

NO SCALE

1

TYPICAL EXTERIOR TWO HOLE LUG

NO SCALE

2

TYPICAL INTERIOR TWO HOLE LUG

NO SCALE

3

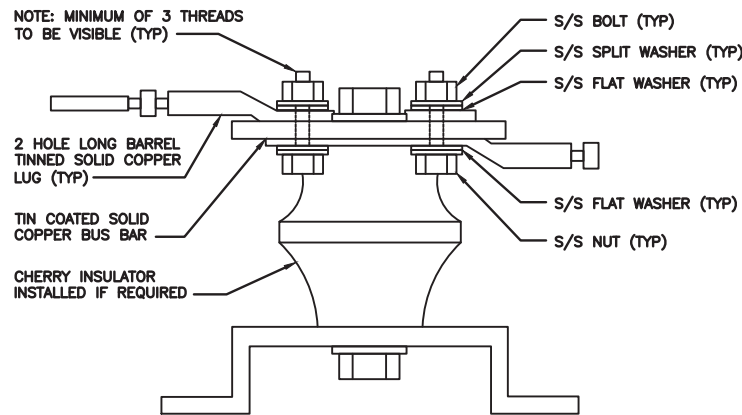

LUG DETAIL

NO SCALE

4

NOT USED

NO SCALE

5

NOT USED

NO SCALE

6

NOT USED

NO SCALE

7

NOT USED

NO SCALE

8

NOT USED

NO SCALE

9



5701 SOUTH SANTA FE DRIVE
LITTLETON, CO 80120



8051 CONGRESS AVENUE
BOCA RATON, FL 33487



1717 S. BOULDER
SUITE 300
TULSA, OK 74119
PH: (918) 587-4630
www.btgrp.com



B&T ENGINEERING, INC.

IT IS A VIOLATION OF LAW FOR ANY PERSON, UNLESS THEY ARE ACTING UNDER THE DIRECTION OF A LICENSED PROFESSIONAL ENGINEER, TO ALTER THIS DOCUMENT.

DRAWN BY: CHECKED BY: APPROVED BY:

RMC BLJ MDW

RFDS REV #: 0

PRELIMINARY DOCUMENTS

SUBMITTALS		
REV	DATE	DESCRIPTION
A	7/28/21	ISSUED FOR REVIEW
0	8/10/21	ISSUED FOR CONSTRUCTION

A&E PROJECT NUMBER
149562.001.01

DISH Wireless L.L.C.
PROJECT INFORMATION

BOBOS00593A
5 TOWN DUMP ROAD
TRURO, MA 02666

SHEET TITLE
GROUNDING DETAILS

SHEET NUMBER
G-3

RF JUMPER COLOR CODING

3/4" TAPE WIDTHS WITH 3/4" SPACING

LOW-BAND RRH -
(600MHz N71 BASEBAND) +
(850MHz N26 BAND) +
(700MHz N29 BAND) - OPTIONAL PER MARKET

ADD FREQUENCY COLOR TO SECTOR BAND
(CBRS WILL USE YELLOW BANDS)

ALPHA RRH				BETA RRH				GAMMA RRH			
PORT 1 + SLANT	PORT 2 - SLANT	PORT 3 + SLANT	PORT 4 - SLANT	PORT 1 + SLANT	PORT 2 - SLANT	PORT 3 + SLANT	PORT 4 - SLANT	PORT 1 + SLANT	PORT 2 - SLANT	PORT 3 + SLANT	PORT 4 - SLANT
RED	RED	RED	RED	BLUE	BLUE	BLUE	BLUE	GREEN	GREEN	GREEN	GREEN
ORANGE	ORANGE	RED	RED	ORANGE	ORANGE	BLUE	BLUE	ORANGE	ORANGE	GREEN	GREEN
	WHITE (-) PORT	ORANGE	ORANGE		WHITE (-) PORT	ORANGE	ORANGE		WHITE (-) PORT	ORANGE	ORANGE
			WHITE (-) PORT				WHITE (-) PORT				WHITE (-) PORT

MID-BAND RRH -
(AWS BANDS N66+N70)

ADD FREQUENCY COLOR TO SECTOR BAND
(CBRS WILL USE YELLOW BANDS)

RED	RED	RED	RED	BLUE	BLUE	BLUE	BLUE	GREEN	GREEN	GREEN	GREEN
PURPLE	PURPLE	RED	RED	PURPLE	PURPLE	BLUE	BLUE	PURPLE	PURPLE	GREEN	GREEN
	WHITE (-) PORT	PURPLE	PURPLE		WHITE (-) PORT	PURPLE	PURPLE		WHITE (-) PORT	PURPLE	PURPLE
			WHITE (-) PORT				WHITE (-) PORT				WHITE (-) PORT

HYBRID/DISCREET CABLES

INCLUDE SECTOR BANDS BEING SUPPORTED
ALONG WITH FREQUENCY BANDS

EXAMPLE 1 - HYBRID, OR DISCREET, SUPPORTS
ALL SECTORS, BOTH LOW-BANDS AND MID-BANDS

EXAMPLE 2 - HYBRID, OR DISCREET, SUPPORTS
CBRS ONLY, ALL SECTORS

EXAMPLE 1	EXAMPLE 2	EXAMPLE 3
RED	RED	RED
BLUE	BLUE	
GREEN	GREEN	ORANGE
ORANGE	YELLOW	PURPLE
PURPLE		

FIBER JUMPERS TO RRHs

LOW-BAND RRH FIBER CABLES HAVE SECTOR
STRIPE ONLY

LOW BAND RRH	HIGH BAND RRH	LOW BAND RRH	HIGH BAND RRH	LOW BAND RRH	HIGH BAND RRH
RED	RED	BLUE	BLUE	GREEN	GREEN
	PURPLE		PURPLE		PURPLE

POWER CABLES TO RRHs

LOW-BAND RRH POWER CABLES HAVE SECTOR
STRIPE ONLY

LOW BAND RRH	HIGH BAND RRH	LOW BAND RRH	HIGH BAND RRH	LOW BAND RRH	HIGH BAND RRH
RED	RED	BLUE	BLUE	GREEN	GREEN
	PURPLE		PURPLE		PURPLE

RET MOTORS AT ANTENNAS

ANTENNA 1 LOW BAND/ "IN"	ANTENNA 1 HIGH BAND/ "IN"	ANTENNA 1 LOW BAND/ "IN"	ANTENNA 1 HIGH BAND/ "IN"	ANTENNA 1 LOW BAND/ "IN"	ANTENNA 1 HIGH BAND/ "IN"
RED	RED	BLUE	BLUE	GREEN	GREEN
	PURPLE		PURPLE		PURPLE

MICROWAVE RADIO LINKS

LINKS WILL HAVE A 1.5-2 INCH WHITE WRAP WITH
THE AZIMUTH COLOR OVERLAPPING IN THE MIDDLE.
ADD ADDITIONAL SECTOR COLOR BANDS FOR EACH
ADDITIONAL MW RADIO.

MICROWAVE CABLES WILL REQUIRE P-TOUCH
LABELS INSIDE THE CABINET TO IDENTIFY THE
LOCAL AND REMOTE SITE ID'S

FORWARD AZIMUTH OF 0-120 DEGREES		FORWARD AZIMUTH OF 120-240 DEGREES		FORWARD AZIMUTH OF 240-360 DEGREES	
PRIMARY	SECONDARY	PRIMARY	SECONDARY	PRIMARY	SECONDARY
WHITE	WHITE	WHITE	WHITE	WHITE	WHITE
RED	RED	BLUE	BLUE	GREEN	GREEN
WHITE	WHITE	WHITE	WHITE	WHITE	WHITE
	RED		BLUE		GREEN
	WHITE		WHITE		WHITE

RF CABLE COLOR CODES

NO SCALE

1

LOW BANDS (N71+N26)
OPTIONAL - (N29)



AWS
(N66+N70+H-BLOCK)



CBRS TECH
(3 GHz)



NEGATIVE SLANT PORT
ON ANT/RRH



ALPHA SECTOR



BETA SECTOR



GAMMA SECTOR



COLOR IDENTIFIER

NO SCALE

2

NOTES

CONTRACTOR TO REFER TO FINAL CONSTRUCTION
RFDS FOR ALL RF DETAILS. FINAL RFDS IS IN
NEXYSONE.

NOT USED

NO SCALE

3

NOT USED

NO SCALE

4



5701 SOUTH SANTA FE DRIVE
LITTLETON, CO 80120



8051 CONGRESS AVENUE
BOCA RATON, FL 33487

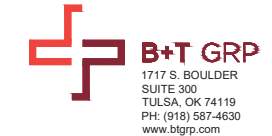

B&T ENGINEERING, INC.

IT IS A VIOLATION OF LAW FOR ANY PERSON,
UNLESS THEY ARE ACTING UNDER THE DIRECTION
OF A LICENSED PROFESSIONAL ENGINEER,
TO ALTER THIS DOCUMENT.

DRAWN BY:	CHECKED BY:	APPROVED BY:
RMC	BLJ	MDW

RFDS REV #: 0

PRELIMINARY DOCUMENTS

SUBMITTALS		
REV	DATE	DESCRIPTION
A	7/28/21	ISSUED FOR REVIEW
0	8/10/21	ISSUED FOR CONSTRUCTION

A&E PROJECT NUMBER
149562.001.01

DISH Wireless L.L.C.
PROJECT INFORMATION

BOBOS00593A
5 TOWN DUMP ROAD
TRURO, MA 02666

SHEET TITLE
RF
CABLE COLOR CODE

SHEET NUMBER
RF-1

EXOTHERMIC CONNECTION
 MECHANICAL CONNECTION
 BUSS BAR INSULATOR
 CHEMICAL ELECTROLYTIC GROUNDING SYSTEM
 TEST CHEMICAL ELECTROLYTIC GROUNDING SYSTEM
 EXOTHERMIC WITH INSPECTION SLEEVE
 GROUNDING BAR
 GROUND ROD
 TEST GROUND ROD WITH INSPECTION SLEEVE
 SINGLE POLE SWITCH
 DUPLEX RECEPTACLE
 DUPLEX GFCI RECEPTACLE
 FLUORESCENT LIGHTING FIXTURE (2) TWO LAMPS 48-T8
 SMOKE DETECTION (DC)
 EMERGENCY LIGHTING (DC)
 SECURITY LIGHT W/PHOTOCELL LITHONIA ALXW
 LED-1-25A400/51K-SR4-120-PE-DBBTXD
 CHAIN LINK FENCE
 WOOD/WROUGHT IRON FENCE
 WALL STRUCTURE
 LEASE AREA
 PROPERTY LINE (PL)
 SETBACKS
 ICE BRIDGE
 CABLE TRAY
 WATER LINE
 UNDERGROUND POWER
 UNDERGROUND TELCO
 OVERHEAD POWER
 OVERHEAD TELCO
 UNDERGROUND TELCO/POWER
 ABOVE GROUND POWER
 ABOVE GROUND TELCO
 ABOVE GROUND TELCO/POWER
 WORKPOINT

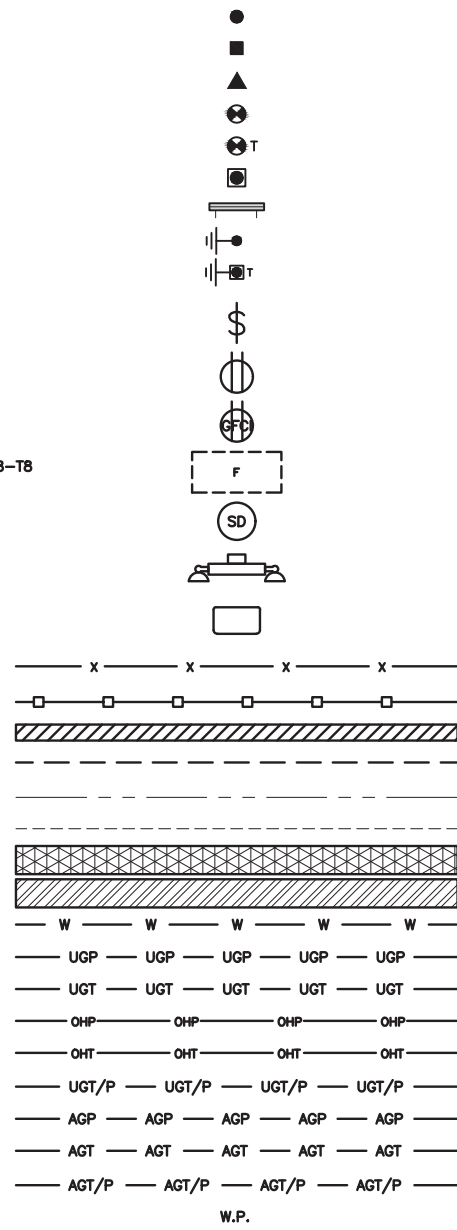

SECTION REFERENCE
 DETAIL REFERENCE

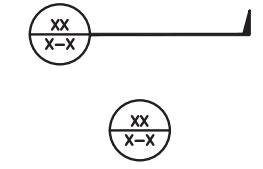

LEGEND

AB	ANCHOR BOLT	IN	INCH	INT	INTERIOR
ABV	ABOVE	INT	INTERIOR	LB(S)	POUND(S)
AC	ALTERNATING CURRENT	LF	LINEAR FEET	LTE	LONG TERM EVOLUTION
ADDL	ADDITIONAL	MAS	MASONRY	MAX	MAXIMUM
AFF	ABOVE FINISHED FLOOR	MB	MACHINE BOLT	MECH	MECHANICAL
AFG	ABOVE FINISHED GRADE	MFR	MANUFACTURER	MGB	MASTER GROUND BAR
AGL	ABOVE GROUND LEVEL	MIN	MINIMUM	MISC	MISCELLANEOUS
AIC	AMPERAGE INTERRUPTION CAPACITY	MTL	METAL	MTS	MANUAL TRANSFER SWITCH
ALUM	ALUMINUM	MW	MICROWAVE	NEC	NATIONAL ELECTRIC CODE
ALT	ALTERNATE	NM	NEWTON METERS	NO.	NUMBER
ANT	ANTENNA	#	NUMBER	NTS	NOT TO SCALE
APPROX	APPROXIMATE	OC	ON-CENTER	OSHA	OCCUPATIONAL SAFETY AND HEALTH ADMINISTRATION
ARCH	ARCHITECTURAL	OPNG	OPENING	OPNG	OPENING
ATS	AUTOMATIC TRANSFER SWITCH	PCS	PRECAST CONCRETE	PCU	PERSONAL COMMUNICATION SERVICES
AWG	AMERICAN WIRE GAUGE	PP	PRIMARY CONTROL UNIT	PRC	PRIMARY RADIO CABINET
BATT	BATTERY	PSF	POLARIZING PRESERVING	PP	POLARIZING PRESERVING
BLDG	BUILDING	PSF	POUNDS PER SQUARE FOOT	PSI	POUNDS PER SQUARE INCH
BLK	BLOCK	PT	PRESSURE TREATED	PWR	POWER CABINET
BLKG	BLOCKING	QTY	QUANTITY	RAD	RADIUS
BM	BEAM	RECT	RECTIFIER	REF	REFERENCE
BTC	BARE TINNED COPPER CONDUCTOR	REINF	REINFORCEMENT	REQ'D	REQUIRED
BOF	BOTTOM OF FOOTING	RET	REMOTE ELECTRIC TILT	RF	RADIO FREQUENCY
CAB	CABINET	RMC	RIGID METALLIC CONDUIT	RRH	REMOTE RADIO HEAD
CANT	CANTILEVERED	RRU	REMOTE RADIO UNIT	RWY	RACEWAY
CHG	CHARGING	SCH	SCHEDULE	SHT	SHEET
CLG	CEILING	SIAD	SMART INTEGRATED ACCESS DEVICE	SIM	SIMILAR
CLR	CLEAR	SPEC	SPECIFICATION	SQ	SQUARE
COL	COLUMN	SS	STAINLESS STEEL	STD	STANDARD
COMM	COMMON	STL	STEEL	TEMP	TEMPORARY
CONC	CONCRETE	THK	THICKNESS	TMA	TOWER MOUNTED AMPLIFIER
CONSTR	CONSTRUCTION	TOA	TOP OF ANTENNA	TN	TOE NAIL
DBL	DOUBLE	TOC	TOP OF CURB	TOF	TOP OF FOUNDATION
DC	DIRECT CURRENT	TOF	TOP OF FOUNDATION	TOP	TOP OF PLATE (PARAPET)
DEPT	DEPARTMENT	TOS	TOP OF STEEL	TOW	TOP OF WALL
DF	DOUGLAS FIR	TOW	TOP OF WALL	TVSS	TRANSIENT VOLTAGE SURGE SUPPRESSION
DIA	DIAMETER	TYP	TYPICAL	UG	UNDERGROUND
DIAG	DIAGONAL	UL	UNDERWRITERS LABORATORY	UNO	UNLESS NOTED OTHERWISE
DIM	DIMENSION	UMTS	UNIVERSAL MOBILE TELECOMMUNICATIONS SYSTEM	UPS	UNINTERRUPTIBLE POWER SYSTEM (DC POWER PLANT)
DWG	DRAWING	VIF	VERIFIED IN FIELD	W	WIDE
DWL	DOWEL	W	WIDE	W/	WITH
EA	EACH	WD	WOOD	WP	WEATHERPROOF
EC	ELECTRICAL CONDUCTOR	WT	WEIGHT		
EL	ELEVATION				
ELEC	ELECTRICAL				
EMT	ELECTRICAL METALLIC TUBING				
ENG	ENGINEER				
EQ	EQUAL				
EXP	EXPANSION				
EXT	EXTERIOR				
EW	EACH WAY				
FAB	FABRICATION				
FF	FINISH FLOOR				
FG	FINISH GRADE				
FIF	FACILITY INTERFACE FRAME				
FIN	FINISH(ED)				
FLR	FLOOR				
FDN	FOUNDATION				
FOC	FACE OF CONCRETE				
FOM	FACE OF MASONRY				
FOS	FACE OF STUD				
FOW	FACE OF WALL				
FS	FINISH SURFACE				
FT	FOOT				
FTG	FOOTING				
GA	GAUGE				
GEN	GENERATOR				
GFCI	GROUND FAULT CIRCUIT INTERRUPTER				
GLB	GLUE LAMINATED BEAM				
GLV	GALVANIZED				
GPS	GLOBAL POSITIONING SYSTEM				
GND	GROUND				
GSM	GLOBAL SYSTEM FOR MOBILE				
HDG	HOT DIPPED GALVANIZED				
HDR	HEADER				
HGR	HANGER				
HVAC	HEAT/VENTILATION/AIR CONDITIONING				
HT	HEIGHT				
IGR	INTERIOR GROUND RING				

ABBREVIATIONS



5701 SOUTH SANTA FE DRIVE
 LITTLETON, CO 80120



8051 CONGRESS AVENUE
 BOCA RATON, FL 33487



B&T ENGINEERING, INC.

IT IS A VIOLATION OF LAW FOR ANY PERSON, UNLESS THEY ARE ACTING UNDER THE DIRECTION OF A LICENSED PROFESSIONAL ENGINEER, TO ALTER THIS DOCUMENT.

DRAWN BY:	CHECKED BY:	APPROVED BY:
RMC	BLJ	MDW

RFDS REV #: 0

PRELIMINARY DOCUMENTS

SUBMITTALS		
REV	DATE	DESCRIPTION
A	7/28/21	ISSUED FOR REVIEW
0	8/10/21	ISSUED FOR CONSTRUCTION

A&E PROJECT NUMBER
 149562.001.01

DISH Wireless L.L.C.
 PROJECT INFORMATION
 BOBOS00593A
 5 TOWN DUMP ROAD
 TRURO, MA 02666

SHEET TITLE
 LEGEND AND ABBREVIATIONS

SHEET NUMBER
GN-1

SITE ACTIVITY REQUIREMENTS:

1. NOTICE TO PROCEED – NO WORK SHALL COMMENCE PRIOR TO CONTRACTOR RECEIVING A WRITTEN NOTICE TO PROCEED (NTP) AND THE ISSUANCE OF A PURCHASE ORDER. PRIOR TO ACCESSING/ENTERING THE SITE YOU MUST CONTACT THE DISH Wireless L.L.C. AND TOWER OWNER NOC & THE DISH Wireless L.L.C. AND TOWER OWNER CONSTRUCTION MANAGER.
2. "LOOK UP" – DISH Wireless L.L.C. AND TOWER OWNER SAFETY CLIMB REQUIREMENT:
THE INTEGRITY OF THE SAFETY CLIMB AND ALL COMPONENTS OF THE CLIMBING FACILITY SHALL BE CONSIDERED DURING ALL STAGES OF DESIGN, INSTALLATION, AND INSPECTION. TOWER MODIFICATION, MOUNT REINFORCEMENTS, AND/OR EQUIPMENT INSTALLATIONS SHALL NOT COMPROMISE THE INTEGRITY OR FUNCTIONAL USE OF THE SAFETY CLIMB OR ANY COMPONENTS OF THE CLIMBING FACILITY ON THE STRUCTURE. THIS SHALL INCLUDE, BUT NOT BE LIMITED TO: PINCHING OF THE WIRE ROPE, BENDING OF THE WIRE ROPE FROM ITS SUPPORTS, DIRECT CONTACT OR CLOSE PROXIMITY TO THE WIRE ROPE WHICH MAY CAUSE FRICTIONAL WEAR, IMPACT TO THE ANCHORAGE POINTS IN ANY WAY, OR TO IMPEDE/BLOCK ITS INTENDED USE. ANY COMPROMISED SAFETY CLIMB, INCLUDING EXISTING CONDITIONS MUST BE TAGGED OUT AND REPORTED TO YOUR DISH Wireless L.L.C. AND DISH Wireless L.L.C. AND TOWER OWNER POC OR CALL THE NOC TO GENERATE A SAFETY CLIMB MAINTENANCE AND CONTRACTOR NOTICE TICKET.
3. PRIOR TO THE START OF CONSTRUCTION, ALL REQUIRED JURISDICTIONAL PERMITS SHALL BE OBTAINED. THIS INCLUDES, BUT IS NOT LIMITED TO, BUILDING, ELECTRICAL, MECHANICAL, FIRE, FLOOD ZONE, ENVIRONMENTAL, AND ZONING. AFTER ONSITE ACTIVITIES AND CONSTRUCTION ARE COMPLETED, ALL REQUIRED PERMITS SHALL BE SATISFIED AND CLOSED OUT ACCORDING TO LOCAL JURISDICTIONAL REQUIREMENTS.
4. ALL CONSTRUCTION MEANS AND METHODS; INCLUDING BUT NOT LIMITED TO, ERECTION PLANS, RIGGING PLANS, CLIMBING PLANS, AND RESCUE PLANS SHALL BE THE RESPONSIBILITY OF THE GENERAL CONTRACTOR RESPONSIBLE FOR THE EXECUTION OF THE WORK CONTAINED HEREIN, AND SHALL MEET ANSI/ASSE A10.48 (LATEST EDITION); FEDERAL, STATE, AND LOCAL REGULATIONS; AND ANY APPLICABLE INDUSTRY CONSENSUS STANDARDS RELATED TO THE CONSTRUCTION ACTIVITIES BEING PERFORMED. ALL RIGGING PLANS SHALL ADHERE TO ANSI/ASSE A10.48 (LATEST EDITION) AND DISH Wireless L.L.C. AND TOWER OWNER STANDARDS, INCLUDING THE REQUIRED INVOLVEMENT OF A QUALIFIED ENGINEER FOR CLASS IV CONSTRUCTION, TO CERTIFY THE SUPPORTING STRUCTURE(S) IN ACCORDANCE WITH ANSI/TIA-322 (LATEST EDITION).
5. ALL SITE WORK TO COMPLY WITH DISH Wireless L.L.C. AND TOWER OWNER INSTALLATION STANDARDS FOR CONSTRUCTION ACTIVITIES ON DISH Wireless L.L.C. AND TOWER OWNER TOWER SITE AND LATEST VERSION OF ANSI/TIA-1019-A-2012 "STANDARD FOR INSTALLATION, ALTERATION, AND MAINTENANCE OF ANTENNA SUPPORTING STRUCTURES AND ANTENNAS."
6. IF THE SPECIFIED EQUIPMENT CAN NOT BE INSTALLED AS SHOWN ON THESE DRAWINGS, THE CONTRACTOR SHALL PROPOSE AN ALTERNATIVE INSTALLATION FOR APPROVAL BY DISH Wireless L.L.C. AND TOWER OWNER PRIOR TO PROCEEDING WITH ANY SUCH CHANGE OF INSTALLATION.
7. ALL MATERIALS FURNISHED AND INSTALLED SHALL BE IN STRICT ACCORDANCE WITH ALL APPLICABLE CODES, REGULATIONS AND ORDINANCES. CONTRACTOR SHALL ISSUE ALL APPROPRIATE NOTICES AND COMPLY WITH ALL LAWS, ORDINANCES, RULES, REGULATIONS AND LAWFUL ORDERS OF ANY PUBLIC AUTHORITY REGARDING THE PERFORMANCE OF THE WORK. ALL WORK CARRIED OUT SHALL COMPLY WITH ALL APPLICABLE MUNICIPAL AND UTILITY COMPANY SPECIFICATIONS AND LOCAL JURISDICTIONAL CODES, ORDINANCES AND APPLICABLE REGULATIONS.
8. THE CONTRACTOR SHALL INSTALL ALL EQUIPMENT AND MATERIALS IN ACCORDANCE WITH MANUFACTURER'S RECOMMENDATIONS UNLESS SPECIFICALLY STATED OTHERWISE.
9. THE CONTRACTOR SHALL CONTACT UTILITY LOCATING SERVICES INCLUDING PRIVATE LOCATES SERVICES PRIOR TO THE START OF CONSTRUCTION.
10. ALL EXISTING ACTIVE SEWER, WATER, GAS, ELECTRIC AND OTHER UTILITIES WHERE ENCOUNTERED IN THE WORK, SHALL BE PROTECTED AT ALL TIMES AND WHERE REQUIRED FOR THE PROPER EXECUTION OF THE WORK, SHALL BE RELOCATED AS DIRECTED BY CONTRACTOR. EXTREME CAUTION SHOULD BE USED BY THE CONTRACTOR WHEN EXCAVATING OR DRILLING PIERS AROUND OR NEAR UTILITIES. CONTRACTOR SHALL PROVIDE SAFETY TRAINING FOR THE WORKING CREW. THIS WILL INCLUDE BUT NOT BE LIMITED TO A) FALL PROTECTION B) CONFINED SPACE C) ELECTRICAL SAFETY D) TRENCHING AND EXCAVATION E) CONSTRUCTION SAFETY PROCEDURES.
11. ALL SITE WORK SHALL BE AS INDICATED ON THE STAMPED CONSTRUCTION DRAWINGS AND DISH PROJECT SPECIFICATIONS, LATEST APPROVED REVISION.
12. CONTRACTOR SHALL KEEP THE SITE FREE FROM ACCUMULATING WASTE MATERIAL, DEBRIS, AND TRASH AT THE COMPLETION OF THE WORK. IF NECESSARY, RUBBISH, STUMPS, DEBRIS, STICKS, STONES AND OTHER REFUSE SHALL BE REMOVED FROM THE SITE AND DISPOSED OF LEGALLY.
13. ALL EXISTING INACTIVE SEWER, WATER, GAS, ELECTRIC AND OTHER UTILITIES, WHICH INTERFERE WITH THE EXECUTION OF THE WORK, SHALL BE REMOVED AND/OR CAPPED, PLUGGED OR OTHERWISE DISCONTINUED AT POINTS WHICH WILL NOT INTERFERE WITH THE EXECUTION OF THE WORK, SUBJECT TO THE APPROVAL OF DISH Wireless L.L.C. AND TOWER OWNER, AND/OR LOCAL UTILITIES.
14. THE CONTRACTOR SHALL PROVIDE SITE SIGNAGE IN ACCORDANCE WITH THE TECHNICAL SPECIFICATION FOR SITE SIGNAGE REQUIRED BY LOCAL JURISDICTION AND SIGNAGE REQUIRED ON INDIVIDUAL PIECES OF EQUIPMENT, ROOMS, AND SHELTERS.
15. THE SITE SHALL BE GRADED TO CAUSE SURFACE WATER TO FLOW AWAY FROM THE CARRIER'S EQUIPMENT AND TOWER AREAS.
16. THE SUB GRADE SHALL BE COMPACTED AND BROUGHT TO A SMOOTH UNIFORM GRADE PRIOR TO FINISHED SURFACE APPLICATION.
17. THE AREAS OF THE OWNERS PROPERTY DISTURBED BY THE WORK AND NOT COVERED BY THE TOWER, EQUIPMENT OR DRIVEWAY, SHALL BE GRADED TO A UNIFORM SLOPE, AND STABILIZED TO PREVENT EROSION AS SPECIFIED ON THE CONSTRUCTION DRAWINGS AND/OR PROJECT SPECIFICATIONS.
18. CONTRACTOR SHALL MINIMIZE DISTURBANCE TO EXISTING SITE DURING CONSTRUCTION. EROSION CONTROL MEASURES, IF REQUIRED DURING CONSTRUCTION, SHALL BE IN CONFORMANCE WITH THE LOCAL GUIDELINES FOR EROSION AND SEDIMENT CONTROL.
19. THE CONTRACTOR SHALL PROTECT EXISTING IMPROVEMENTS, PAVEMENTS, CURBS, LANDSCAPING AND STRUCTURES. ANY DAMAGED PART SHALL BE REPAIRED AT CONTRACTOR'S EXPENSE TO THE SATISFACTION OF OWNER.
20. CONTRACTOR SHALL LEGALLY AND PROPERLY DISPOSE OF ALL SCRAP MATERIALS SUCH AS COAXIAL CABLES AND OTHER ITEMS REMOVED FROM THE EXISTING FACILITY. ANTENNAS AND RADIOS REMOVED SHALL BE RETURNED TO THE OWNER'S DESIGNATED LOCATION.
21. CONTRACTOR SHALL LEAVE PREMISES IN CLEAN CONDITION. TRASH AND DEBRIS SHOULD BE REMOVED FROM SITE ON A DAILY BASIS.
22. NO FILL OR EMBANKMENT MATERIAL SHALL BE PLACED ON FROZEN GROUND. FROZEN MATERIALS, SNOW OR ICE SHALL NOT BE PLACED IN ANY FILL OR EMBANKMENT.

GENERAL NOTES:

- 1.FOR THE PURPOSE OF CONSTRUCTION DRAWING, THE FOLLOWING DEFINITIONS SHALL APPLY:
CONTRACTOR:GENERAL CONTRACTOR RESPONSIBLE FOR CONSTRUCTION
CARRIER:DISH Wireless L.L.C.
TOWER OWNER:TOWER OWNER
2. THESE DRAWINGS HAVE BEEN PREPARED USING STANDARDS OF PROFESSIONAL CARE AND COMPLETENESS NORMALLY EXERCISED UNDER SIMILAR CIRCUMSTANCES BY REPUTABLE ENGINEERS IN THIS OR SIMILAR LOCALITIES. IT IS ASSUMED THAT THE WORK DEPICTED WILL BE PERFORMED BY AN EXPERIENCED CONTRACTOR AND/OR WORKPEOPLE WHO HAVE A WORKING KNOWLEDGE OF THE APPLICABLE CODE STANDARDS AND REQUIREMENTS AND OF INDUSTRY ACCEPTED STANDARD GOOD PRACTICE. AS NOT EVERY CONDITION OR ELEMENT IS (OR CAN BE) EXPLICITLY SHOWN ON THESE DRAWINGS, THE CONTRACTOR SHALL USE INDUSTRY ACCEPTED STANDARD GOOD PRACTICE FOR MISCELLANEOUS WORK NOT EXPLICITLY SHOWN.
3. THESE DRAWINGS REPRESENT THE FINISHED STRUCTURE. THEY DO NOT INDICATE THE MEANS OR METHODS OF CONSTRUCTION. THE CONTRACTOR SHALL BE SOLELY RESPONSIBLE FOR THE CONSTRUCTION MEANS, METHODS, TECHNIQUES, SEQUENCES, AND PROCEDURES. THE CONTRACTOR SHALL PROVIDE ALL MEASURES NECESSARY FOR PROTECTION OF LIFE AND PROPERTY DURING CONSTRUCTION. SUCH MEASURES SHALL INCLUDE, BUT NOT BE LIMITED TO, BRACING, FORMWORK, SHORING, ETC. SITE VISITS BY THE ENGINEER OR HIS REPRESENTATIVE WILL NOT INCLUDE INSPECTION OF THESE ITEMS AND IS FOR STRUCTURAL OBSERVATION OF THE FINISHED STRUCTURE ONLY.
4. NOTES AND DETAILS IN THE CONSTRUCTION DRAWINGS SHALL TAKE PRECEDENCE OVER GENERAL NOTES AND TYPICAL DETAILS. WHERE NO DETAILS ARE SHOWN, CONSTRUCTION SHALL CONFORM TO SIMILAR WORK ON THE PROJECT, AND/OR AS PROVIDED FOR IN THE CONTRACT DOCUMENTS. WHERE DISCREPANCIES OCCUR BETWEEN PLANS, DETAILS, GENERAL NOTES, AND SPECIFICATIONS, THE GREATER, MORE STRICT REQUIREMENTS, SHALL GOVERN. IF FURTHER CLARIFICATION IS REQUIRED CONTACT THE ENGINEER OF RECORD.
5. SUBSTANTIAL EFFORT HAS BEEN MADE TO PROVIDE ACCURATE DIMENSIONS AND MEASUREMENTS ON THE DRAWINGS TO ASSIST IN THE FABRICATION AND/OR PLACEMENT OF CONSTRUCTION ELEMENTS BUT IT IS THE SOLE RESPONSIBILITY OF THE CONTRACTOR TO FIELD VERIFY THE DIMENSIONS, MEASUREMENTS, AND/OR CLEARANCES SHOWN IN THE CONSTRUCTION DRAWINGS PRIOR TO FABRICATION OR CUTTING OF ANY NEW OR EXISTING CONSTRUCTION ELEMENTS. IF IT IS DETERMINED THAT THERE ARE DISCREPANCIES AND/OR CONFLICTS WITH THE CONSTRUCTION DRAWINGS THE ENGINEER OF RECORD IS TO BE NOTIFIED AS SOON AS POSSIBLE.
6. PRIOR TO THE SUBMISSION OF BIDS, THE BIDDING CONTRACTOR SHALL VISIT THE CELL SITE TO FAMILIARIZE WITH THE EXISTING CONDITIONS AND TO CONFIRM THAT THE WORK CAN BE ACCOMPLISHED AS SHOWN ON THE CONSTRUCTION DRAWINGS. ANY DISCREPANCY FOUND SHALL BE BROUGHT TO THE ATTENTION OF CARRIER POC AND TOWER OWNER.
7. ALL MATERIALS FURNISHED AND INSTALLED SHALL BE IN STRICT ACCORDANCE WITH ALL APPLICABLE CODES, REGULATIONS AND ORDINANCES. CONTRACTOR SHALL ISSUE ALL APPROPRIATE NOTICES AND COMPLY WITH ALL LAWS, ORDINANCES, RULES, REGULATIONS AND LAWFUL ORDERS OF ANY PUBLIC AUTHORITY REGARDING THE PERFORMANCE OF THE WORK. ALL WORK CARRIED OUT SHALL COMPLY WITH ALL APPLICABLE MUNICIPAL AND UTILITY COMPANY SPECIFICATIONS AND LOCAL JURISDICTIONAL CODES, ORDINANCES AND APPLICABLE REGULATIONS.
8. UNLESS NOTED OTHERWISE, THE WORK SHALL INCLUDE FURNISHING MATERIALS, EQUIPMENT, APPURTENANCES AND LABOR NECESSARY TO COMPLETE ALL INSTALLATIONS AS INDICATED ON THE DRAWINGS.
9. THE CONTRACTOR SHALL INSTALL ALL EQUIPMENT AND MATERIALS IN ACCORDANCE WITH MANUFACTURER'S RECOMMENDATIONS UNLESS SPECIFICALLY STATED OTHERWISE.
10. IF THE SPECIFIED EQUIPMENT CAN NOT BE INSTALLED AS SHOWN ON THESE DRAWINGS, THE CONTRACTOR SHALL PROPOSE AN ALTERNATIVE INSTALLATION FOR APPROVAL BY THE CARRIER AND TOWER OWNER PRIOR TO PROCEEDING WITH ANY SUCH CHANGE OF INSTALLATION.
11. CONTRACTOR IS TO PERFORM A SITE INVESTIGATION, BEFORE SUBMITTING BIDS, TO DETERMINE THE BEST ROUTING OF ALL CONDUITS FOR POWER, AND TELCO AND FOR GROUNDING CABLES AS SHOWN IN THE POWER, TELCO, AND GROUNDING PLAN DRAWINGS.
12. THE CONTRACTOR SHALL PROTECT EXISTING IMPROVEMENTS, PAVEMENTS, CURBS, LANDSCAPING AND STRUCTURES. ANY DAMAGED PART SHALL BE REPAIRED AT CONTRACTOR'S EXPENSE TO THE SATISFACTION OF DISH Wireless L.L.C. AND TOWER OWNER
13. CONTRACTOR SHALL LEGALLY AND PROPERLY DISPOSE OF ALL SCRAP MATERIALS SUCH AS COAXIAL CABLES AND OTHER ITEMS REMOVED FROM THE EXISTING FACILITY. ANTENNAS REMOVED SHALL BE RETURNED TO THE OWNER'S DESIGNATED LOCATION.
14. CONTRACTOR SHALL LEAVE PREMISES IN CLEAN CONDITION. TRASH AND DEBRIS SHOULD BE REMOVED FROM SITE ON A DAILY BASIS.



5701 SOUTH SANTA FE DRIVE
LITTLETON, CO 80120



8051 CONGRESS AVENUE
BOCA RATON, FL 33487



1717 S. BOULDER
SUITE 300
TULSA, OK 74119
PH: (918) 587-4630
www.btgrp.com



B&T ENGINEERING, INC.

IT IS A VIOLATION OF LAW FOR ANY PERSON, UNLESS THEY ARE ACTING UNDER THE DIRECTION OF A LICENSED PROFESSIONAL ENGINEER, TO ALTER THIS DOCUMENT.

DRAWN BY: CHECKED BY: APPROVED BY:

RMC BLJ MDW

RFDS REV #: 0

PRELIMINARY DOCUMENTS

SUBMITTALS		
REV	DATE	DESCRIPTION
A	7/28/21	ISSUED FOR REVIEW
0	8/10/21	ISSUED FOR CONSTRUCTION

A&E PROJECT NUMBER
149562.001.01

DISH Wireless L.L.C.
PROJECT INFORMATION

BOBOS00593A
5 TOWN DUMP ROAD
TRURO, MA 02666

SHEET TITLE
GENERAL NOTES

SHEET NUMBER
GN-2

CONCRETE, FOUNDATIONS, AND REINFORCING STEEL:

1. ALL CONCRETE WORK SHALL BE IN ACCORDANCE WITH THE ACI 301, ACI 318, ACI 336, ASTM A184, ASTM A185 AND THE DESIGN AND CONSTRUCTION SPECIFICATION FOR CAST-IN-PLACE CONCRETE.
2. UNLESS NOTED OTHERWISE, SOIL BEARING PRESSURE USED FOR DESIGN OF SLABS AND FOUNDATIONS IS ASSUMED TO BE 1000 psf.
3. ALL CONCRETE SHALL HAVE A MINIMUM COMPRESSIVE STRENGTH (f'c) OF 3000 psi AT 28 DAYS, UNLESS NOTED OTHERWISE. NO MORE THAN 90 MINUTES SHALL ELAPSE FROM BATCH TIME TO TIME OF PLACEMENT UNLESS APPROVED BY THE ENGINEER OF RECORD. TEMPERATURE OF CONCRETE SHALL NOT EXCEED 90°f AT TIME OF PLACEMENT.
4. CONCRETE EXPOSED TO FREEZE-THAW CYCLES SHALL CONTAIN AIR ENTRAINING ADMIXTURES. AMOUNT OF AIR ENTRAINMENT TO BE BASED ON SIZE OF AGGREGATE AND F3 CLASS EXPOSURE (VERY SEVERE). CEMENT USED TO BE TYPE II PORTLAND CEMENT WITH A MAXIMUM WATER-TO-CEMENT RATIO (W/C) OF 0.45.
5. ALL STEEL REINFORCING SHALL CONFORM TO ASTM A615. ALL WELDED WIRE FABRIC (WWF) SHALL CONFORM TO ASTM A185. ALL SPLICES SHALL BE CLASS "B" TENSION SPLICES, UNLESS NOTED OTHERWISE. ALL HOOKS SHALL BE STANDARD 90 DEGREE HOOKS, UNLESS NOTED OTHERWISE. YIELD STRENGTH (Fy) OF STANDARD DEFORMED BARS ARE AS FOLLOWS:
 - #4 BARS AND SMALLER 40 ksi
 - #5 BARS AND LARGER 60 ksi
6. THE FOLLOWING MINIMUM CONCRETE COVER SHALL BE PROVIDED FOR REINFORCING STEEL UNLESS SHOWN OTHERWISE ON DRAWINGS:
 - CONCRETE CAST AGAINST AND PERMANENTLY EXPOSED TO EARTH 3"
 - CONCRETE EXPOSED TO EARTH OR WEATHER:
 - #6 BARS AND LARGER 2"
 - #5 BARS AND SMALLER 1-1/2"
 - CONCRETE NOT EXPOSED TO EARTH OR WEATHER:
 - SLAB AND WALLS 3/4"
 - BEAMS AND COLUMNS 1-1/2"
7. A TOOLED EDGE OR A 3/4" CHAMFER SHALL BE PROVIDED AT ALL EXPOSED EDGES OF CONCRETE, UNLESS NOTED OTHERWISE, IN ACCORDANCE WITH ACI 301 SECTION 4.2.4.

ELECTRICAL INSTALLATION NOTES:

1. ALL ELECTRICAL WORK SHALL BE PERFORMED IN ACCORDANCE WITH THE PROJECT SPECIFICATIONS, NEC AND ALL APPLICABLE FEDERAL, STATE, AND LOCAL CODES/ORDINANCES.
2. CONDUIT ROUTINGS ARE SCHEMATIC. CONTRACTOR SHALL INSTALL CONDUITS SO THAT ACCESS TO EQUIPMENT IS NOT BLOCKED AND TRIP HAZARDS ARE ELIMINATED.
3. WIRING, RACEWAY AND SUPPORT METHODS AND MATERIALS SHALL COMPLY WITH THE REQUIREMENTS OF THE NEC.
4. ALL CIRCUITS SHALL BE SEGREGATED AND MAINTAIN MINIMUM CABLE SEPARATION AS REQUIRED BY THE NEC.
- 4.1. ALL EQUIPMENT SHALL BEAR THE UNDERWRITERS LABORATORIES LABEL OF APPROVAL, AND SHALL CONFORM TO REQUIREMENT OF THE NATIONAL ELECTRICAL CODE.
- 4.2. ALL OVERCURRENT DEVICES SHALL HAVE AN INTERRUPTING CURRENT RATING THAT SHALL BE GREATER THAN THE SHORT CIRCUIT CURRENT TO WHICH THEY ARE SUBJECTED, 22,000 AIC MINIMUM. VERIFY AVAILABLE SHORT CIRCUIT CURRENT DOES NOT EXCEED THE RATING OF ELECTRICAL EQUIPMENT IN ACCORDANCE WITH ARTICLE 110.24 NEC OR THE MOST CURRENT ADOPTED CODE PRE THE GOVERNING JURISDICTION.
5. EACH END OF EVERY POWER PHASE CONDUCTOR, GROUNDING CONDUCTOR, AND TELCO CONDUCTOR OR CABLE SHALL BE LABELED WITH COLOR-CODED INSULATION OR ELECTRICAL TAPE (3M BRAND, 1/2" PLASTIC ELECTRICAL TAPE WITH UV PROTECTION, OR EQUAL). THE IDENTIFICATION METHOD SHALL CONFORM WITH NEC AND OSHA.
6. ALL ELECTRICAL COMPONENTS SHALL BE CLEARLY LABELED WITH LAMICOID TAGS SHOWING THEIR RATED VOLTAGE, PHASE CONFIGURATION, WIRE CONFIGURATION, POWER OR AMPACITY RATING AND BRANCH CIRCUIT ID NUMBERS (i.e. PANEL BOARD AND CIRCUIT ID'S).
7. PANEL BOARDS (ID NUMBERS) SHALL BE CLEARLY LABELED WITH PLASTIC LABELS.
8. TIE WRAPS ARE NOT ALLOWED.
9. ALL POWER AND EQUIPMENT GROUND WIRING IN TUBING OR CONDUIT SHALL BE SINGLE COPPER CONDUCTOR (#14 OR LARGER) WITH TYPE THHW, THWN, THWN-2, XHHW, XHHW-2, THW, THW-2, RHW, OR RHW-2 INSULATION UNLESS OTHERWISE SPECIFIED.
10. SUPPLEMENTAL EQUIPMENT GROUND WIRING LOCATED INDOORS SHALL BE SINGLE COPPER CONDUCTOR (#6 OR LARGER) WITH TYPE THHW, THWN, THWN-2, XHHW, XHHW-2, THW, THW-2, RHW, OR RHW-2 INSULATION UNLESS OTHERWISE SPECIFIED.
11. POWER AND CONTROL WIRING IN FLEXIBLE CORD SHALL BE MULTI-CONDUCTOR, TYPE SOOW CORD (#14 OR LARGER) UNLESS OTHERWISE SPECIFIED.
12. POWER AND CONTROL WIRING FOR USE IN CABLE TRAY SHALL BE MULTI-CONDUCTOR, TYPE TC CABLE (#14 OR LARGER), WITH TYPE THHW, THWN, THWN-2, XHHW, XHHW-2, THW, THW-2, RHW, OR RHW-2 INSULATION UNLESS OTHERWISE SPECIFIED.
13. ALL POWER AND GROUNDING CONNECTIONS SHALL BE CRIMP-STYLE, COMPRESSION WIRE LUGS AND WIRE NUTS BY THOMAS AND BETTS (OR EQUAL). LUGS AND WIRE NUTS SHALL BE RATED FOR OPERATION NOT LESS THAN 75° C (90° C IF AVAILABLE).
14. RACEWAY AND CABLE TRAY SHALL BE LISTED OR LABELED FOR ELECTRICAL USE IN ACCORDANCE WITH NEMA, UL, ANSI/IEEE AND NEC.
15. ELECTRICAL METALLIC TUBING (EMT), INTERMEDIATE METAL CONDUIT (IMC), OR RIGID METAL CONDUIT (RMC) SHALL BE USED FOR EXPOSED INDOOR LOCATIONS.

16. ELECTRICAL METALLIC TUBING (EMT) OR METAL-CLAD CABLE (MC) SHALL BE USED FOR CONCEALED INDOOR LOCATIONS.
17. SCHEDULE 40 PVC UNDERGROUND ON STRAIGHTS AND SCHEDULE 80 PVC FOR ALL ELBOWS/90s AND ALL APPROVED ABOVE GRADE PVC CONDUIT.
18. LIQUID-TIGHT FLEXIBLE METALLIC CONDUIT (LIQUID-TITE FLEX) SHALL BE USED INDOORS AND OUTDOORS, WHERE VIBRATION OCCURS OR FLEXIBILITY IS NEEDED.
19. CONDUIT AND TUBING FITTINGS SHALL BE THREADED OR COMPRESSION-TYPE AND APPROVED FOR THE LOCATION USED. SET SCREW FITTINGS ARE NOT ACCEPTABLE.
20. CABINETS, BOXES AND WIRE WAYS SHALL BE LABELED FOR ELECTRICAL USE IN ACCORDANCE WITH NEMA, UL, ANSI/IEEE AND THE NEC.
21. WIREWAYS SHALL BE METAL WITH AN ENAMEL FINISH AND INCLUDE A HINGED COVER, DESIGNED TO SWING OPEN DOWNWARDS (WIREMOLD SPECMATE WIREWAY).
22. SLOTTED WIRING DUCT SHALL BE PVC AND INCLUDE COVER (PANDUIT TYPE E OR EQUAL).
23. CONDUITS SHALL BE FASTENED SECURELY IN PLACE WITH APPROVED NON-PERFORATED STRAPS AND HANGERS. EXPLOSIVE DEVICES (i.e. POWDER-ACTUATED) FOR ATTACHING HANGERS TO STRUCTURE WILL NOT BE PERMITTED. CLOSELY FOLLOW THE LINES OF THE STRUCTURE, MAINTAIN CLOSE PROXIMITY TO THE STRUCTURE AND KEEP CONDUITS IN TIGHT ENVELOPES. CHANGES IN DIRECTION TO ROUTE AROUND OBSTACLES SHALL BE MADE WITH CONDUIT OUTLET BODIES. CONDUIT SHALL BE INSTALLED IN A NEAT AND WORKMANLIKE MANNER. PARALLEL AND PERPENDICULAR TO STRUCTURE WALL AND CEILING LINES. ALL CONDUIT SHALL BE FISHED TO CLEAR OBSTRUCTIONS. ENDS OF CONDUITS SHALL BE TEMPORARILY CAPPED FLUSH TO FINISH GRADE TO PREVENT CONCRETE, PLASTER OR DIRT FROM ENTERING. CONDUITS SHALL BE RIGIDLY CLAMPED TO BOXES BY GALVANIZED MALLEABLE IRON BUSHING ON INSIDE AND GALVANIZED MALLEABLE IRON LOCKNUT ON OUTSIDE AND INSIDE.
24. EQUIPMENT CABINETS, TERMINAL BOXES, JUNCTION BOXES AND PULL BOXES SHALL BE GALVANIZED OR EPOXY-COATED SHEET STEEL SHALL MEET OR EXCEED UL 50 AND BE RATED NEMA 1 (OR BETTER) FOR INTERIOR LOCATIONS AND NEMA 3 (OR BETTER) FOR EXTERIOR LOCATIONS.
25. METAL RECEPTACLE, SWITCH AND DEVICE BOXES SHALL BE GALVANIZED, EPOXY-COATED OR NON-CORRODING; SHALL MEET OR EXCEED UL 514A AND NEMA OS 1 AND BE RATED NEMA 1 (OR BETTER) FOR INTERIOR LOCATIONS AND WEATHER PROTECTED (WP OR BETTER) FOR EXTERIOR LOCATIONS.
26. NONMETALLIC RECEPTACLE, SWITCH AND DEVICE BOXES SHALL MEET OR EXCEED NEMA OS 2 (NEWEST REVISION) AND BE RATED NEMA 1 (OR BETTER) FOR INTERIOR LOCATIONS AND WEATHER PROTECTED (WP OR BETTER) FOR EXTERIOR LOCATIONS.
27. THE CONTRACTOR SHALL NOTIFY AND OBTAIN NECESSARY AUTHORIZATION FROM THE CARRIER AND/OR DISH Wireless L.L.C. AND TOWER OWNER BEFORE COMMENCING WORK ON THE AC POWER DISTRIBUTION PANELS.
28. THE CONTRACTOR SHALL PROVIDE NECESSARY TAGGING ON THE BREAKERS, CABLES AND DISTRIBUTION PANELS IN ACCORDANCE WITH THE APPLICABLE CODES AND STANDARDS TO SAFEGUARD LIFE AND PROPERTY.
29. INSTALL LAMICOID LABEL ON THE METER CENTER TO SHOW "DISH Wireless L.L.C.".
30. ALL EMPTY/SPARE CONDUITS THAT ARE INSTALLED ARE TO HAVE A METERED MULE TAPE PULL CORD INSTALLED.



5701 SOUTH SANTA FE DRIVE
LITTLETON, CO 80120



8051 CONGRESS AVENUE
BOCA RATON, FL 33487



1717 S. BOULDER
SUITE 300
TULSA, OK 74119
PH: (918) 587-4630
www.btgrp.com



B&T ENGINEERING, INC.

IT IS A VIOLATION OF LAW FOR ANY PERSON, UNLESS THEY ARE ACTING UNDER THE DIRECTION OF A LICENSED PROFESSIONAL ENGINEER, TO ALTER THIS DOCUMENT.

DRAWN BY:	CHECKED BY:	APPROVED BY:
RMC	BLJ	MDW

RFDS REV #: 0

PRELIMINARY DOCUMENTS

SUBMITTALS		
REV	DATE	DESCRIPTION
A	7/28/21	ISSUED FOR REVIEW
0	8/10/21	ISSUED FOR CONSTRUCTION

A&E PROJECT NUMBER
149562.001.01

DISH Wireless L.L.C.
PROJECT INFORMATION

BOBOS00593A
5 TOWN DUMP ROAD
TRURO, MA 02666

SHEET TITLE
GENERAL NOTES

SHEET NUMBER
GN-3

GROUNDING NOTES:

1. ALL GROUND ELECTRODE SYSTEMS (INCLUDING TELECOMMUNICATION, RADIO, LIGHTNING PROTECTION AND AC POWER GES'S) SHALL BE BONDED TOGETHER AT OR BELOW GRADE, BY TWO OR MORE COPPER BONDING CONDUCTORS IN ACCORDANCE WITH THE NEC.
2. THE CONTRACTOR SHALL PERFORM IEEE FALL-OF-POTENTIAL RESISTANCE TO EARTH TESTING (PER IEEE 1100 AND 81) FOR GROUND ELECTRODE SYSTEMS, THE CONTRACTOR SHALL FURNISH AND INSTALL SUPPLEMENTAL GROUND ELECTRODES AS NEEDED TO ACHIEVE A TEST RESULT OF 5 OHMS OR LESS.
3. THE CONTRACTOR IS RESPONSIBLE FOR PROPERLY SEQUENCING GROUNDING AND UNDERGROUND CONDUIT INSTALLATION AS TO PREVENT ANY LOSS OF CONTINUITY IN THE GROUNDING SYSTEM OR DAMAGE TO THE CONDUIT AND PROVIDE TESTING RESULTS.
4. METAL CONDUIT AND TRAY SHALL BE GROUNDED AND MADE ELECTRICALLY CONTINUOUS WITH LISTED BONDING FITTINGS OR BY BONDING ACROSS THE DISCONTINUITY WITH #6 COPPER WIRE UL APPROVED GROUNDING TYPE CONDUIT CLAMPS.
5. METAL RACEWAY SHALL NOT BE USED AS THE NEC REQUIRED EQUIPMENT GROUND CONDUCTOR. STRANDED COPPER CONDUCTORS WITH GREEN INSULATION, SIZED IN ACCORDANCE WITH THE NEC, SHALL BE FURNISHED AND INSTALLED WITH THE POWER CIRCUITS TO BTS EQUIPMENT.
6. EACH CABINET FRAME SHALL BE DIRECTLY CONNECTED TO THE MASTER GROUND BAR WITH GREEN INSULATED SUPPLEMENTAL EQUIPMENT GROUND WIRES, #6 STRANDED COPPER OR LARGER FOR INDOOR BTS; #2 BARE SOLID TINNED COPPER FOR OUTDOOR BTS.
7. CONNECTIONS TO THE GROUND BUS SHALL NOT BE DOUBLED UP OR STACKED BACK TO BACK CONNECTIONS ON OPPOSITE SIDE OF THE GROUND BUS ARE PERMITTED.
8. ALL EXTERIOR GROUND CONDUCTORS BETWEEN EQUIPMENT/GROUND BARS AND THE GROUND RING SHALL BE #2 SOLID TINNED COPPER UNLESS OTHERWISE INDICATED.
9. ALUMINUM CONDUCTOR OR COPPER CLAD STEEL CONDUCTOR SHALL NOT BE USED FOR GROUNDING CONNECTIONS.
10. USE OF 90° BENDS IN THE PROTECTION GROUNDING CONDUCTORS SHALL BE AVOIDED WHEN 45° BENDS CAN BE ADEQUATELY SUPPORTED.
11. EXOTHERMIC WELDS SHALL BE USED FOR ALL GROUNDING CONNECTIONS BELOW GRADE.
12. ALL GROUND CONNECTIONS ABOVE GRADE (INTERIOR AND EXTERIOR) SHALL BE FORMED USING HIGH PRESS CRIMPS.
13. COMPRESSION GROUND CONNECTIONS MAY BE REPLACED BY EXOTHERMIC WELD CONNECTIONS.
14. ICE BRIDGE BONDING CONDUCTORS SHALL BE EXOTHERMICALLY BONDED OR BOLTED TO THE BRIDGE AND THE TOWER GROUND BAR.
15. APPROVED ANTIOXIDANT COATINGS (i.e. CONDUCTIVE GEL OR PASTE) SHALL BE USED ON ALL COMPRESSION AND BOLTED GROUND CONNECTIONS.
16. ALL EXTERIOR GROUND CONNECTIONS SHALL BE COATED WITH A CORROSION RESISTANT MATERIAL.
17. MISCELLANEOUS ELECTRICAL AND NON-ELECTRICAL METAL BOXES, FRAMES AND SUPPORTS SHALL BE BONDED TO THE GROUND RING, IN ACCORDANCE WITH THE NEC.
18. BOND ALL METALLIC OBJECTS WITHIN 6 ft OF MAIN GROUND RING WITH (1) #2 BARE SOLID TINNED COPPER GROUND CONDUCTOR.
19. GROUND CONDUCTORS USED FOR THE FACILITY GROUNDING AND LIGHTNING PROTECTION SYSTEMS SHALL NOT BE ROUTED THROUGH METALLIC OBJECTS THAT FORM A RING AROUND THE CONDUCTOR, SUCH AS METALLIC CONDUITS, METAL SUPPORT CLIPS OR SLEEVES THROUGH WALLS OR FLOORS. WHEN IT IS REQUIRED TO BE HOUSED IN CONDUIT TO MEET CODE REQUIREMENTS OR LOCAL CONDITIONS, NON-METALLIC MATERIAL SUCH AS PVC CONDUIT SHALL BE USED. WHERE USE OF METAL CONDUIT IS UNAVOIDABLE (i.e., NONMETALLIC CONDUIT PROHIBITED BY LOCAL CODE) THE GROUND CONDUCTOR SHALL BE BONDED TO EACH END OF THE METAL CONDUIT.
20. ALL GROUNDS THAT TRANSITION FROM BELOW GRADE TO ABOVE GRADE MUST BE #2 BARE SOLID TINNED COPPER IN 3/4" NON-METALLIC, FLEXIBLE CONDUIT FROM 24" BELOW GRADE TO WITHIN 3" TO 6" OF CAD-WELD TERMINATION POINT. THE EXPOSED END OF THE CONDUIT MUST BE SEALED WITH SILICONE CAULK. (ADD TRANSITIONING GROUND STANDARD DETAIL AS WELL).
21. BUILDINGS WHERE THE MAIN GROUNDING CONDUCTORS ARE REQUIRED TO BE ROUTED TO GRADE, THE CONTRACTOR SHALL ROUTE TWO GROUNDING CONDUCTORS FROM THE ROOFTOP, TOWERS, AND WATER TOWERS GROUNDING RING, TO THE EXISTING GROUNDING SYSTEM, THE GROUNDING CONDUCTORS SHALL NOT BE SMALLER THAN 2/0 COPPER. ROOFTOP GROUNDING RING SHALL BE BONDED TO THE EXISTING GROUNDING SYSTEM, THE BUILDING STEEL COLUMNS, LIGHTNING PROTECTION SYSTEM, AND BUILDING MAIN WATER LINE (FERROUS OR NONFERROUS METAL PIPING ONLY). DO NOT ATTACH GROUNDING TO FIRE SPRINKLER SYSTEM PIPES.



5701 SOUTH SANTA FE DRIVE
LITTLETON, CO 80120



8051 CONGRESS AVENUE
BOCA RATON, FL 33487



1717 S. BOULDER
SUITE 300
TULSA, OK 74119
PH: (918) 587-4630
www.blgrp.com



B&T ENGINEERING, INC.

IT IS A VIOLATION OF LAW FOR ANY PERSON, UNLESS THEY ARE ACTING UNDER THE DIRECTION OF A LICENSED PROFESSIONAL ENGINEER, TO ALTER THIS DOCUMENT.

DRAWN BY: CHECKED BY: APPROVED BY:

RMC BLJ MDW

RFDS REV #: 0

PRELIMINARY DOCUMENTS

SUBMITTALS		
REV	DATE	DESCRIPTION
A	7/28/21	ISSUED FOR REVIEW
0	8/10/21	ISSUED FOR CONSTRUCTION

A&E PROJECT NUMBER
149562.001.01

DISH Wireless L.L.C.
PROJECT INFORMATION

BOBOS00593A
5 TOWN DUMP ROAD
TRURO, MA 02666

SHEET TITLE
GENERAL NOTES

SHEET NUMBER
GN-4



Radio Frequency Emissions Analysis Report



Site ID: BOBOS00593A

SBA - Town Dump Road
5 Town Dump Road
Truro, MA 02666

April 27, 2023

Fox Hill Telecom Project Number: 230389

Site Compliance Summary	
Compliance Status:	COMPLIANT
Site total MPE% of FCC general population allowable limit:	11.94 %

April 27, 2023

Dish Wireless
5701 South Santa Fe Drive
Littleton, CO 80120

Emissions Analysis for Site: **BOBOS00593A – SBA - Town Dump Road**

Fox Hill Telecom, Inc (“Fox Hill”) was directed to analyze the proposed radio installation for Dish Wireless, LLC (Dish) facility located at **5 Town Dump Road, Truro, MA**, for the purpose of determining whether the emissions from the Proposed Dish radio and antenna installation located on this property are within specified federal limits.

All information used in this report was analyzed as a percentage of current Maximum Permissible Exposure (% MPE) as listed in the FCC OET Bulletin 65 Edition 97-01 and ANSI/IEEE Std C95.1. The FCC regulates Maximum Permissible Exposure in units of microwatts per square centimeter ($\mu\text{W}/\text{cm}^2$). The number of $\mu\text{W}/\text{cm}^2$ calculated at each sample point is called the power density. The exposure limit for power density varies depending upon the frequencies being utilized. Wireless Carriers and Paging Services use different frequency bands each with different exposure limits, therefore it is necessary to report results and limits in terms of percent MPE rather than power density.

All results were compared to the FCC (Federal Communications Commission) radio frequency exposure rules, 47 CFR 1.1307(b)(1) – (b)(3), to determine compliance with the Maximum Permissible Exposure (MPE) limits for General Population/Uncontrolled environments as defined below.

General population/uncontrolled exposure limits apply to situations in which the general population may be exposed or in which persons who are exposed as a consequence of their employment may not be made fully aware of the potential for exposure or cannot exercise control over their exposure. Therefore, members of the general population would always be considered under this category when exposure is not employment related, for example, in the case of a telecommunications tower that exposes persons in a nearby residential area.

Population exposure to radio frequencies is regulated and enforced in units of microwatts per square centimeter ($\mu\text{W}/\text{cm}^2$). The general population exposure limit for the 600 MHz band is approximately $400 \mu\text{W}/\text{cm}^2$. The general population exposure limit for the 1900 MHz (PCS) and 2100 MHz (AWS / AWS-4) bands is $1000 \mu\text{W}/\text{cm}^2$. Because each carrier will be using different frequency bands, and each frequency band has different exposure limits, it is necessary to report the percentage of MPE rather than power density.



Occupational/controlled exposure limits apply to situations in which persons are exposed as a consequence of their employment and in which those persons who are exposed have been made fully aware of the potential for exposure and can exercise control over their exposure. Occupational/controlled exposure limits also apply where exposure is of a transient nature as a result of incidental passage through a location where exposure levels may be above general population/uncontrolled limits (see below), as long as the exposed person has been made fully aware of the potential for exposure and can exercise control over his or her exposure by leaving the area or by some other appropriate means.

Additional details can be found in FCC OET 65.



CALCULATIONS

Calculations were performed for the proposed upgrades to the Dish Wireless antenna facility located at **5 Town Dump Road, Truro, MA**, using the equipment information listed below. All calculations were performed per the specifications under FCC OET 65 for far field modeling calculations.

In OET-65, plane wave power densities in the Far Field of an antenna are calculated by considering antenna gain and reflective waves that would contribute to exposure.

Since the radiation pattern of an antenna has developed in the **Far Field** region the power gain in specific directions needs to be considered in exposure predictions to yield an Effective Radiated Power (ERP) in each specific direction from the antenna. Also, since the vertical radiation pattern of the antenna is considered, the exposure calculations would most likely be reduced significantly at ground level, resulting in a more realistic estimate of the actual exposure levels. To determine a worst-case scenario at each point along the calculation radials, each point was calculated using the antenna gain value at each angle of incident and compared against the result using an isotropic radiator at the antenna height with the greater of the two used to yield the more pessimistic far field value for each point along the calculation radial.

Additionally, to model a truly "worst case" prediction of exposure levels at or near a surface, such as at ground-level or on a rooftop, reflection off the surface of antenna radiation power can be assumed, resulting in a potential 1.6 times increase in power density in calculating far field power density values.

With these factors Considered, the worst case **Far Field prediction model** utilized in this analysis is determined by the following equation:

Equation 9 per FCC OET65 for Far Field Modeling

$$S = \frac{33.4 \text{ ERP}}{R^2}$$

S = Power Density (in $\mu\text{w}/\text{cm}^2$)

ERP = Effective Radiated Power from antenna (watts)

R = Distance from the antenna (meters)

Predicted far field power density values for all carriers identified in this report were calculated 6 feet above the ground level and are displayed as a percentage of the applicable FCC standards. All emissions values for other carriers were calculated using the same Far Field model outlined above, using industry standard radio configurations and frequency band selection based upon available licenses in this geographic area for emissions contribution estimates.



For each Dish sector the following channel counts, frequency bands and power levels were utilized as shown in *Table 1*:

Technology	Frequency Band	Channel Count	Transmit Power per Channel (W)
5G	n71 (600 MHz)	4	61.5
5G	n70 (AWS-4 / 1995-2020)	4	40
5G	n66 (AWS-4 / 2180-2200)	4	40

Table 1: Channel Data Table



The following **Dish** antennas listed in *Table 2* were used in the modeling for transmission in the 600 MHz (n71) frequency band and the 2100 MHz (AWS 4) frequency bands at 1995-2020 MHz (n70) and 2180-2200 MHz (n66). This is based on feedback from Dish regarding anticipated antenna selection. Maximum gain values for all antennas are listed in the Inventory and Power Data table below.

Sector	Antenna Number	Antenna Make / Model	Antenna Centerline (ft)
A	1	JMA MX08FRO665-21	155
B	1	JMA MX08FRO665-21	155
C	1	JMA MX08FRO665-21	155

Table 2: Antenna Data

All calculations were done with respect to uncontrolled / general population threshold limits.



RESULTS

Per the calculations completed for the proposed **Dish** configurations *Table 3* shows resulting emissions power levels and percentages of the FCC’s allowable general population limit.

Antenna ID	Antenna Make / Model	Frequency Bands	Antenna Gain (dBd)	Channel Count	Total TX Power (W)	ERP (W)	MPE %
Antenna A1	JMA MX08FRO665-21	n71 (600 MHz) / n70 (AWS-4 / 1995-2020) / n66 (AWS-4 / 2180-2200)	11.45 / 16.15 / 16.65	12	566	17,426.72	3.59
Sector A Composite MPE%							3.59
Antenna B1	JMA MX08FRO665-21	n71 (600 MHz) / n70 (AWS-4 / 1995-2020) / n66 (AWS-4 / 2180-2200)	11.45 / 16.15 / 16.65	12	566	17,426.72	3.59
Sector B Composite MPE%							3.59
Antenna C1	JMA MX08FRO665-21	n71 (600 MHz) / n70 (AWS-4 / 1995-2020) / n66 (AWS-4 / 2180-2200)	11.45 / 16.15 / 16.65	12	566	17,426.72	3.59
Sector C Composite MPE%							3.59

Table 3: Dish Emissions Levels

The Following table (*Table 4*) shows all additional carriers on site and their emissions contribution estimates, along with the newly calculated **Dish** far field emissions contributions per this report. FCC OET 65 specifies that for carriers utilizing directional antennas the highest recorded sector value be used for composite site emissions values due to their greatly reduced emissions contributions in the directions of the adjacent sectors. For this site, all three sectors have the same configuration yielding the same results for all three sectors. *Table 5* below shows a summary for each **Dish** Sector as well as the composite emissions value for the site.

Site Composite MPE%	
Carrier	MPE%
Dish – Max Per Sector Value	3.59 %
AT&T	2.76 %
T-Mobile	1.58 %
Verizon Wireless	3.04 %
Sprint	0.97 %
Site Total MPE %:	11.94 %

Table 4: All Carrier MPE Contributions

Dish Sector A Total:	3.59 %
Dish Sector B Total:	3.59 %
Dish Sector C Total:	3.59 %
Site Total:	11.94 %

Table 5: Site MPE Summary



Table 6 below details a breakdown by frequency band and technology for the MPE power values for the maximum calculated **Dish** sector(s). For this site, all three sectors have the same configuration yielding the same results for all three sectors.

Dish _ Frequency Band / Technology Max Power Values (Per Sector)	# Channels	Watts ERP (Per Channel)	Height (feet)	Total Power Density ($\mu\text{W}/\text{cm}^2$)	Frequency (MHz)	Allowable MPE ($\mu\text{W}/\text{cm}^2$)	Calculated % MPE
Dish n71 (600 MHz) 5G	4	858.77	155	3.52	n71 (600 MHz)	400	0.88%
Dish n70 (AWS-4 / 1995-2020) 5G	4	1,648.39	155	8.80	n70 (AWS-4 / 1995-2020)	1000	0.88%
Dish n66 (AWS-4 / 2180-2200) 5G	4	1,849.52	155	18.30	n66 (AWS-4 / 2180-2200)	1000	1.83%
						Total:	3.59 %

Table 6: Dish Maximum Sector MPE Power Values



Summary

All calculations performed for this analysis yielded results that were **within** the allowable limits for general population exposure to RF Emissions.

The anticipated maximum composite contributions from the Dish facility as well as the site composite emissions value with regards to compliance with FCC's allowable limits for general population exposure to RF Emissions are shown here:

Dish Sector	Power Density Value (%)
Sector A:	3.59 %
Sector B:	3.59 %
Sector C:	3.59 %
Dish Maximum Total (per sector):	3.59 %
Site Total:	11.94 %
Site Compliance Status:	COMPLIANT

The anticipated composite emissions value for this site, assuming all carriers present, is **11.94 %** of the allowable FCC established general population limit sampled at the ground level. This is based upon the far field calculations performed for all carriers identified in this report.

FCC guidelines state that if a site is found to be out of compliance (over allowable thresholds), that carriers over a 5% contribution to the composite value will require measures to bring the site into compliance. For this facility, the composite values calculated were well within the allowable 100% threshold standard per the federal government.

Scott Heffernan
Principal RF Engineer
Fox Hill Telecom, Inc
Worcester, MA 01609
(978)660-3998