

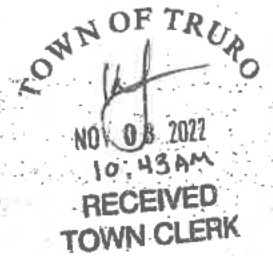

**TOWN OF TRURO**  
Conservation Commission

**PUBLIC MEETING AGENDA**  
Monday, November 7, 2022  
Meeting start time 5:00



## Remote Meeting Access Instructions

This will be a remote meeting. Citizens can view the meeting on Channel 18 in Truro and on the Town's web site on the "Truro TV Channel 18" button under "Helpful Links" on the homepage. Once the meeting has started, click on the green "Watch" button in the upper right of the page. To provide comment during the meeting, please call-in toll free at 1 877 309 2073 and enter the following access code when prompted: 464-567-165 # To join this meeting from your computer, tablet or smartphone:

<https://global.gotomeeting.com/join/464567165>

Please note that there may be a slight delay (15-30 seconds) between the meeting and the live-stream (and television broadcast). If you are watching the meeting and calling in, please lower the volume on your computer or television during public comment so that you may be heard clearly. We ask that you identify yourself when calling in; citizens may also provide public comment for this meeting by emailing the Conservation Agent at [cbecbe@truro-ma.gov](mailto:cbecbe@truro-ma.gov) with your comments.

**PUBLIC HEARINGS:** The Truro Conservation Commission holds the following public hearings in accordance with the provisions of MGL Ch. 131, s. 40, the Wetlands Protection Act and the Truro Conservation Bylaw, Chapter 8:

1. **Notice of Intent: 39 Bay View Road, Lawrence Gottesdiener; SE# 75-1140;** demo/rebuild dwelling, add pool; Buffer Zone to a Coastal Bank. (Map 39, Parcel 65) *(Request to Withdraw the Application)*
2. **Notice of Intent: 6 River View Road, Elizabeth & Robert Morrison SE# 75-1154;** construction of a single-family residence; Buffer Zone to a Coastal Bank, Riverfront Area. (Map 50, Parcel 267)  
*(continued from 10/3/2022; the applicant has requested a further continuance to Dec 5)*
3. **Notice of Intent: 4 Payomet Lane; 4, 6&23 Corn Hill Landing; 2&3 Corn Hill Path, Rob Berman, SE#75-1159;** reconstruction & maintenance of sand drift fence; Coastal Dune, Land Subject to Coastal Storm Flowage, Barrier Beach. (Map 45, Parcel 18, 19, 24, 25, 28 & 32)
4. **Notice of Intent: 33 Black Pond Road, Catherine Shainberg;** two additions; Bordering Vegetated Wetland. (Map 61, Parcel 12)
5. **Request for an Amended Order of Conditions: 82 South Pamet Road, Victor Rivera; SE# 75-1121;** invasive species removal; Bordering Vegetated Wetlands, Buffer Zone to a Coastal Bank; Land Subject to Coastal Storm Flowage (Map 51, Parcel 57)
  - a. **Field Change:** 82 South Pamet Rd, Victor Rivera; SE# 75-1121
6. **Request for Determination of Applicability: 405 Shore Road, Ken Shapiro;** 10'x 12' shed; Coastal Dune, Barrier Beach, Land Subject to Coastal Storm. (Map 10, Parcel 5)
7. **Request for Determination of Applicability: 5 Joseph's Road, Abigail Swan & Robert Galligan;** septic system upgrade; Bordering Vegetated Wetland, Land Subject to Coastal Storm Flowage. (Map 46, Parcel 25)
8. **Notice of Intent: 2 Marian Lane, Paul & Nancy Fenichel;** construction of a new deck & screen porch; Coastal Bank. (Map 50, Parcel 47)

9. Administrative Review Permit requests: (1) 5 Marshall Lane: removal of invasives & brush;(2) 1 Dune Way: 1:1 replacement railings and decking; (3) 10 Pilgrims Path: 60-day extension request: dead tree removal, tread & stringer replacement; (4) 2 Meetinghouse Road: dead tree removal & ambulance clearance; (5) 26 Pond Road: 30-day extension request (step replacement); (6) 510 Shore Road, U:A: 30-day extension request (deck board and railing replacement); (7) 510 Shore Road, U:B: deck board and railing replacement

10. Certificate of Compliance: 118 North Pamet Road SE #75-1110

11. Minutes: 7/11/2022; 8/1/2022

12. Discussion and vote to designate representative member to the Community Preservation Committee (CPC)- request to return Diane Messinger to CPC as representative member



Site visits: Commissioners will meet at Town Hall on Monday, November 7, 2022, at 10:00 AM and proceed to:

- 1.) 2 Marian Lane;
- 2.) 82 South Pamet Road;
- 3.) 5 Joseph's Road;
- 4.) Community stair at Corn Hill Landing;
- 5.) 405 Shore Road;



## Arozana Davis

---

**From:** Benjamin Zehnder <[REDACTED]>  
**Sent:** Tuesday, November 1, 2022 9:46 AM  
**To:** Arozana Davis  
**Cc:** 'Daniel A. Ojala, PE PLS'; Priscilla Leclerc; Emily Beebe; Eric Rochon  
**Subject:** RE: 39 Bay View Rd

Hello Arozana and Emily:

I am requesting that the 39 Bay View Road Conservation matter be withdrawn. The applicant will refile when they have their new plans completed.

My thanks to you and the Commission for your continued attention.

Ben

*Please note new email and contact information below and update your address book:*

Benjamin E. Zehnder  
Benjamin E. Zehnder, LLC  
62 Route 6A, Unit B  
Orleans, MA 02653  
508.255.7766 – Office  
508.246.4064 – Mobile  
[bzehnder@zehnderllc.com](mailto:bzehnder@zehnderllc.com)

This email message and any files transmitted with it contain PRIVILEGED AND CONFIDENTIAL INFORMATION and are intended only for the person(s) to whom this email message is addressed. As such, they are subject to attorney-client privilege and you are hereby notified that any dissemination or copying of the information received in this email message is strictly prohibited. If you have received this email message in error, please notify the sender immediately by telephone or email and destroy the original message without making a copy. Thank you.

EMAIL DISCLAIMER: We do not email Non-Public Confidential Information in a non-secure method. Accordingly, such confidential information, including account information and personally identifiable information should not be transmitted by non-encrypted email/email attachments. Use of non-encrypted email is inherently insecure. In no event shall we accept any responsibility for the loss, use or misuse of any information including confidential information, which is sent to us by email or an email attachment, nor can we guarantee receipt, accuracy or response to any email.

**From:** Arozana Davis <ADavis@truro-ma.gov>  
**Sent:** Monday, October 31, 2022 9:00 AM  
**To:** Benjamin Zehnder <bzehnder@zehnderllc.com>  
**Cc:** 'Daniel A. Ojala, PE PLS' <downcape@downcape.com>; Priscilla Leclerc <priscilla@downcape.com>; Emily Beebe <EBeeBe@truro-ma.gov>  
**Subject:** 39 Bay View Rd

Good Morning Ben & Dan,

Just checking in to see if there is any updated information for this above referenced property. We have to compile packets this week and it would be great if I could get any updated materials sooner than later.

Thank you!

Arozana

*Arozana D.T. Davis / Assistant Health & Conservation Agent / Town of Truro / 24 Town Hall Rd, Truro MA 02666*

*/ P: 508-214-0202 / F: 508-349-5508 / [adavis@truro-ma.gov](mailto:adavis@truro-ma.gov)*

This communication may contain privileged or other confidential information. If you are not the intended recipient, or believe that you have received this communication in error, please do not print, copy, retransmit, disseminate, or otherwise use the information. Also, please indicate that to the sender and delete the copy you received. When writing or responding, please remember that the Secretary of State's Office has determined that email is a public record. Please take notice: All e-mail communications sent or received by persons using the Town of Truro network may be subject to disclosure under the Massachusetts Public Records Law (M.G.L. Chapter 66, Section 10) and the Federal Freedom of Information Act

**CAUTION:** This email originated from outside of the organization. Do not click links or open attachments unless you recognize the sender and know the content is safe.

**Arozana Davis**

---

**From:** David Lyttle <davidlyttle@ryder-wilcox.com>  
**Sent:** Thursday, November 3, 2022 9:12 AM  
**To:** Emily Beebe; Arozana Davis  
**Subject:** Morrison - 6 River View Road SE 75-1154

Good morning Emily & Arozana

Please let this email serve as a request for continuing subject hearing to December 5<sup>th</sup>. We are still working on some changes to the location of the dwelling which I expect the Commission will look more favorably on.

Thank you, David

David A. Lyttle, P.L.S.  
Ryder & Wilcox  
PO Box 439  
South Orleans, MA 02662  
508-255-8312  
[davidlyttle@ryder-wilcox.com](mailto:davidlyttle@ryder-wilcox.com)  
[www.ryder-wilcox.com](http://www.ryder-wilcox.com)

**CAUTION: This email originated from outside of the organization. Do not click links or open attachments unless you recognize the sender and know the content is safe.**

PROJECT NARRATIVE

SEP 30 2022

**1. Introduction**

This Notice of Intent (NOI) application has been submitted for the proposed reconstruction and maintenance of an existing sand drift fence (also called a "serpentine fence") along six properties located from 4 Payomet Lane to 4 Corn Hill Landing in Truro (the site). The Town of Truro Assessors Department references the parcels as Parcel #45-18-0 (4 Payomet Lane), Parcel #45-19-0 (23 Corn Hill Landing), Parcel #45-24-0 (3 Corn Hill Path), Parcel #45-25-0 (2 Corn Hill Path), Parcel #45-28-0 (6 Corn Hill Landing) and Parcel #45-32-0 (4 Corn Hill Landing). The existing sand drift fence is approximately 890 feet long and located close to the boundary of a Coastal Beach and Coastal Dune within Land Subject to Coastal Storm Flowage. This application is being submitted in accordance with the Massachusetts Wetlands Protection Act and the Town of Truro Wetlands Protection Bylaw.

**2. Site Description**

The site consists of six residential lots located to the west of Payomet Road, Corn Hill Path and Corn Hill Landing. Each site consists of a single-family home with appurtenances along the top of a large Coastal Bank that abuts Cape Cod Bay. The Coastal Bank is very well vegetated and appears mostly stable at this time. Along the toe of the bank ECR identified a Coastal Dune and Coastal Beach system that extends seaward to Cape Cod Bay. An existing sand drift fence is located across all six lots, roughly parallel to the toe of the Bank and located close to the boundary of Coastal Beach and Coastal Dune. The majority of the existing sand drift fence is in disrepair and/or has been significantly buried by accumulated sand. Environmental Consulting & Restoration, LLC (ECR) delineated the limit of the Coastal Beach and Coastal Dune along the six properties on April 20, 2022. ECR placed Coastal Dune flags #CD1 to #CD14 along the landward limit of the dune at the toe of the Bank and # CB1 to #CB14 along the landward limit of the Coastal Beach. As a result of the field work and review of available environmental databases, we are able to confirm that the site contains the following coastal resource areas and areas of Conservation Commission jurisdiction:

- Coastal Beach
- Coastal Dune
- Coastal Bank
- Land Subject to Coastal Storm Flowage (FEMA flood zone VE)

Notes:

1. The site is not located within an area mapped as Priority Habitat & Estimated Habitat for Rare Species according to the Massachusetts Natural Heritage & Endangered Species Program (MaNHESP).
2. The site does not contain or is near a Certified Vernal Pool according to the MaNHESP.
3. The site is located within an area mapped as Land Subject to Coastal Storm Flowage (FEMA Zone VE).
4. The site does not contain a U.S.G.S. mapped stream.
5. The site is not located within an Area of Critical Environmental Concern (ACEC).

**3. Proposed Activities**

The purpose of this application is to authorize the reconstruction and maintenance of the existing sand drift fence along the Coastal Beach/Coastal Dune boundary at the site. Access, equipment, materials and methodology are all detailed below:

- Access – Corn Hill Public Landing shall be utilized for both equipment and material access. This is contingent on the on approval from the Town of Truro. Construction is anticipated to begin in late fall/early winter of 2022.
- Equipment – The required equipment shall include a small excavator and skid steer/small end loader.

**4 Payomet Lane, 4, 6 & 23 Corn Hill Landing, 2 & 3 Corn Hill Path  
Notice of Intent**

- **Materials of Construction**
  - a. Posts – Existing post will be utilized to the maximum extent possible (about 85% of the existing posts are expected to be usable). Approximately 8 posts are missing/broken and will need to be replaced with cedar or non-treated pine posts 7" to 12" diameter.
  - b. Fence Panels – Non-treated pine will be used for the panels. The dimensions of the replaced panels, rails and slats will be the same as the existing panels.
  - c. Hardware – Galvanized bolts, washers and nuts (no nails) will be used to secure the panels to the posts.
  
- **Damaged Panels – Nearly all of the existing panels are damaged to a greater or lesser extent.**
  - a. If the rails are broken or cracked, the entire panel will be removed and replaced with a new panel.
  - b. If the existing rails (top and bottom) are in reasonable condition, only the missing or damaged slats will be replaced. Please note, it is difficult to determine the condition of many of the bottom rails since the majority of the existing drift fence is partially buried and therefore, the decision on panel removal will be made at time of construction. However, it has been estimated that 80 to 90 percent of the panels will need total replacement.
  
- **Method of Panel Removal/Repair/Replacement**
  - a. New panels will be fabricated off site at the contractor's yard and moved by truck to the Corn Hill Landing. An end loader will move the new panels down the beach to the installation location.
  - b. Regarding the existing, damaged panels, the excavator will first dig a small trench along the front face of the panels to expose the bottom, the panel will be disconnected from the post and lifted out in whole or in parts depending on the degree of damage, the end loader will then remove the panel from the beach to Corn Hill Landing where a dumpster will be positioned to handle the debris.
  - c. If necessary, where the existing piles are significantly buried, the piles will be pulled up to leave approximately 6 feet of pile below grade and enough pile above grade to attached the new panel and ensure the drift fence can function to capture sand.
  - d. The new panel and/or new slats will then be installed either at the same elevation as the old panel or at the new elevation of the raised piles.
  - e. Sand will then be replaced in the small trench that was previously excavated to remove the panel to include burring the toe of the new panel.

**4. Compliance with Massachusetts Wetlands Protection Regulations (310 CMR 10.00)**

The following sections analyze the proposed project against the relevant performance standards for Coastal Beach and Coastal Dune. For Coastal Beach, only standard (3) to this activity since standard (4) applies to solid fill structures like groins and jetties, standard (5) applies to beach nourishment which is not being proposed, standard (6) refers to activities in Tidal

Flats and standard (7) applies to rare species habitat. For Coastal Dune, only standard (4) would not apply since it addresses accessory projects related to existing buildings. There are no performance standards for Land Subject to Coastal Storm Flowage. Below, the performance standards are shown in italics to include an analysis of how the proposed project meets those specific standards, directly following not italicized.

*310 CMR 10.27 Coastal Beach means unconsolidated sediment subject to wave, tidal and coastal storm action which forms the gently sloping shore of a body of salt water and includes tidal flats. Coastal beaches extend from the mean low water line landward to the dune line, coastal bankline or the seaward edge of existing human-made structures, when these structures replace one of the above lines, whichever is closest to the ocean.*

*WHEN A COASTAL BEACH IS DETERMINED TO BE SIGNIFICANT TO STORM DAMAGE PREVENTION, FLOOD CONTROL, OR PROTECTION OF WILDLIFE HABITAT, 310 CMR 10.27(3) THROUGH (7) SHALL APPLY: (3) Any project on a coastal beach, except any project permitted under 310 CMR 10.30(3)(a), shall not have an adverse effect by increasing erosion, decreasing the volume or changing the form of any such coastal beach or an adjacent or downdrift coastal beach.*



Drift fences are designed to allow for the passage of water and sand. The trapping of sand will only increase the volume on the beach. That will change the beach form in a positive way. None of the drift fences that we have seen in 20 years of working with them have caused erosion to any such coastal beach or an adjacent or downdrift coastal beach.

*310 CMR 10.28 Coastal Dune means any natural hill, mound or ridge of sediment landward of a coastal beach deposited by wind action or storm overwash. Coastal dune also means sediment deposited by artificial means and serving the purpose of storm damage prevention or flood control.*

**WHEN A COASTAL DUNE IS DETERMINED TO BE SIGNIFICANT TO STORM DAMAGE PREVENTION, FLOOD CONTROL OR THE PROTECTION OF WILDLIFE HABITAT, 310 10.28(3) THROUGH (6) SHALL APPLY:**

- (3) *Any alteration of, or structure on, a coastal dune or within 100 feet of a coastal dune shall not have an adverse effect on the coastal dune by*(a) *affecting the ability of waves to remove sand from the dune;*  
(a) *affecting the ability of waves to remove sand from the dune;*  
(b) *disturbing the vegetative cover so as to destabilize the dune;*  
(c) *causing any modification of the dune form that would increase the potential for storm or flood damage;*  
(d) *interfering with the landward or lateral movement of the dune;*  
(e) *causing removal of sand from the dune artificially; or*  
(f) *interfering with mapped or otherwise identified bird nesting habitat.*

Waves will have the ability to remove sand from the dune at any time since the fence has openings equal to the size of the slats making them 50% permeable. The fence may only temporarily disturb the forthcoming vegetative cover, but not permanently destabilize the dune. Since there are spaces in the fence, shading is not expected to alter vegetative growth either. While the fence is designed to trap sand and build up the dune, it will not interfere with the landward or lateral movement of the dune. All sand altered by the fence installation will remain in the dune or beach. There is no sand to be artificially removed.

(5): *The following projects may be permitted, provided that they adhere to the provisions of 310 CMR 10.28(3):*

- (a) *pedestrian walkways, designed to minimize the disturbance to the vegetative cover and traditional bird nesting habitat;*  
(b) *fencing and other devices designed to increase dune development; and*  
(c) *plantings compatible with the natural vegetative cover.*

Subsection (b) specifically applies to this project. The proposed fence that has evolved is still designed to trap windblown sand and increase dune development. Excessively high tides and storms have eroded the seaward face of the dunes and created a steeper slope which cannot trap and hold the sand. With the placement of the fence along the beach/dune boundary, it is the best location and will have the best opportunity to trap sand being blown off the beach.

## **5. Compliance with Truro Conservation Regulations (Section II, Chapters 1.0 – 7.0)**

The following sections analyze the proposed project against the relevant performance standards for Land Subject to Coastal Storm Flowage (LSCSF). For LSCSF, standards in Chapter 2.05 (c) apply to the proposed activity. Below, the performance standards are shown in italics to include an analysis of how the proposed project meets those specific standards, directly following not italicized.

### *Chapter 2.05(c.)*

*Any activity subject to jurisdiction and proposed on LSCSF shall not:*

- i. Reduce the ability of the resource to absorb and contain flood waters;*
- ii. Reduce the ability of the resource to buffer more inland areas from flooding and wave damage;*
- iii. Displace or divert flood waters to other areas;*
- iv. Cause or create the likelihood of damage by debris to other structures on land within the flood plain (collateral damage); built structures such as stairs or walkways shall be seasonally removable;*

**4 Payomet Lane, 4, 6 & 23 Corn Hill Landing, 2 & 3 Corn Hill Path  
Notice of Intent**

- v. Cause ground or surface pollution triggered by coastal storm flowage; and*
- vi. Reduce the ability of the resource to serve as a wildlife habitat and migration corridor through activities such as, but not limited to the removal of vegetative cover and/or installation of fencing and other similar structures;*
- vii. Any activity proposed in the floodplain may require mitigation to enhance or restore natural functions of the floodplain.*

The 4-foot high, open slat fence will allow flood waters to pass beyond the fence and therefore will not reduce the ability of the Coastal Beach (beach) and Coastal Dune (dune) to absorb contain such waters. The beach and dune will continue to buffer more inland areas from flooding and wave damage because of the low height and permeability of the fence. The more sand that the fence can trap will actually increase the buffer capacity of the dune. The fence does not act like a solid fill structure which may displace or divert flood waters to other areas. Flood waters will continue to move landward. The sturdier materials proposed with this drift fence will be durable and long lasting so that the likelihood for collateral damage is not caused or created by the fence. No pollutants are proposed with the activity. No vegetative cover will be removed during the reconstruction of the fence.

Regarding Section 7.05, this reconstruction and maintenance of an existing drift fence is designed to assist in dune building by trapping windblown sand allowing it to revegetate naturally. It is not designed to be a substantial beach restoration project or a shore protection project for an eroding Coastal Bank. Therefore, no beach nourishment and planting of beachgrass are proposed. All other conditions cited in 7.05(5, 9 and 13) are acceptable.

#### **6. Summary**

In the final project analysis, the sturdy drift fence will occur at a site containing a Coastal Beach, Coastal Dune and Land Subject to Coastal Storm Flowage. Reconstruction and maintenance of the existing drift fence will protect the interests of storm damage prevention, flood control and wildlife habitat. Based on the interpretation of performance standards for work within these resource areas, as outlined in the Massachusetts 2017 manual *Applying the Massachusetts Coastal Wetlands Regulations* (applicable to both the state and local regulations), the project is compliant.

4 Payomet Lane, 4, 6 & 23 Corn Hill Landing, 2 & 3 Corn Hill Path  
Site Photographs



Photograph #1 – View south along the existing sand drift fence.



Photograph #2 - View north along the existing sand drift fence. Many existing support piles will need to be raised and resecured.



4 Payomet Lane, 4, 6 & 23 Corn Hill Landing, 2 & 3 Corn Hill Path  
Site Photographs



Photograph #3 – Another view north along the existing sand drift fence where much of the fencing sections will need to be replaced.



Photograph #4—View south along the back side of the existing fence within the Coastal Dune.



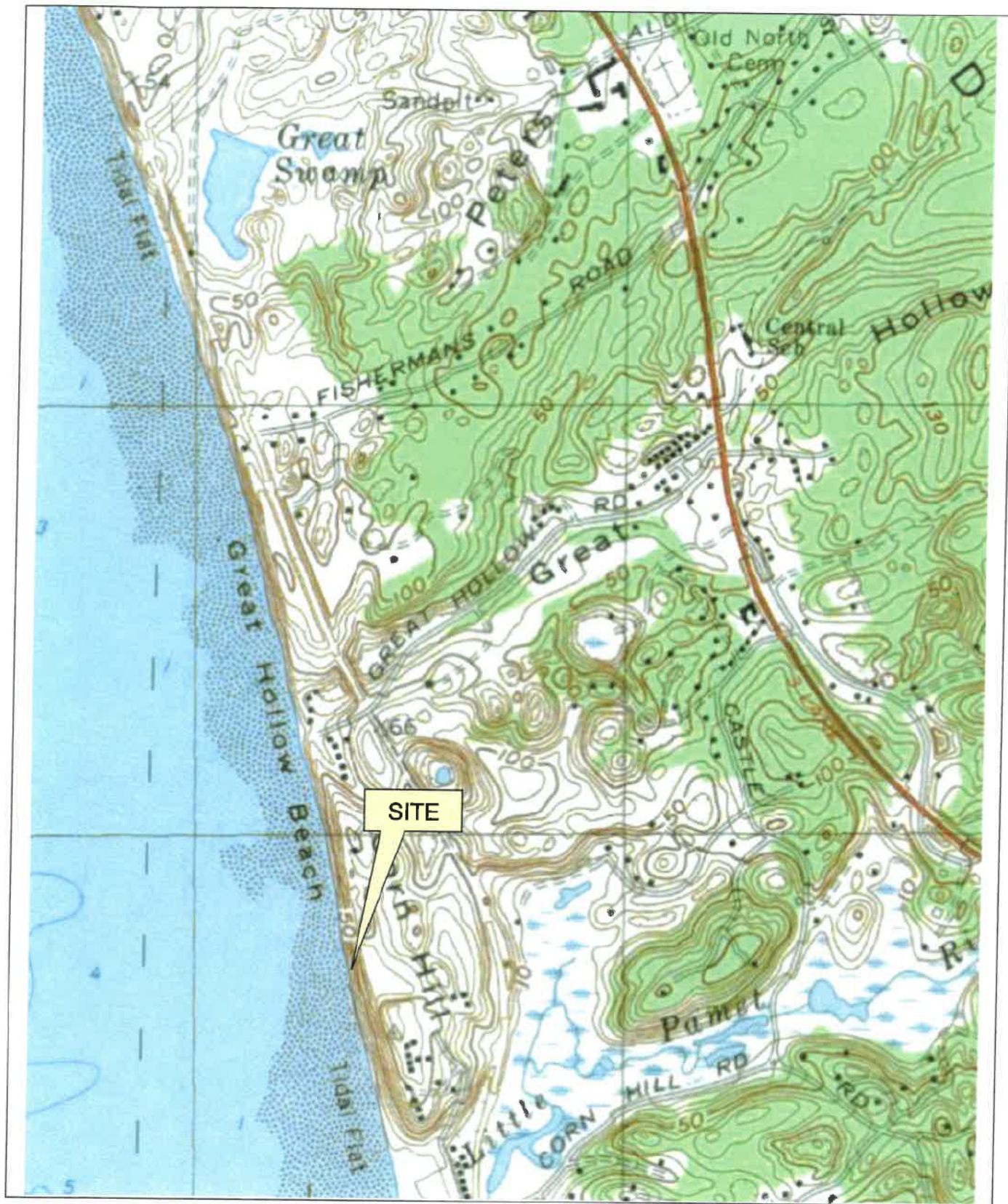

**USGS SITE LOCUS MAP**  
**4 Payomet Lane, 23 Corn Hill Landing, 3 Corn Hill Path, 2 Corn Hill Path, 6 Corn Hill Landing, 4 Corn Hill Landing**  
**Truro, Massachusetts**

Source: MassGIS Oliver Viewer





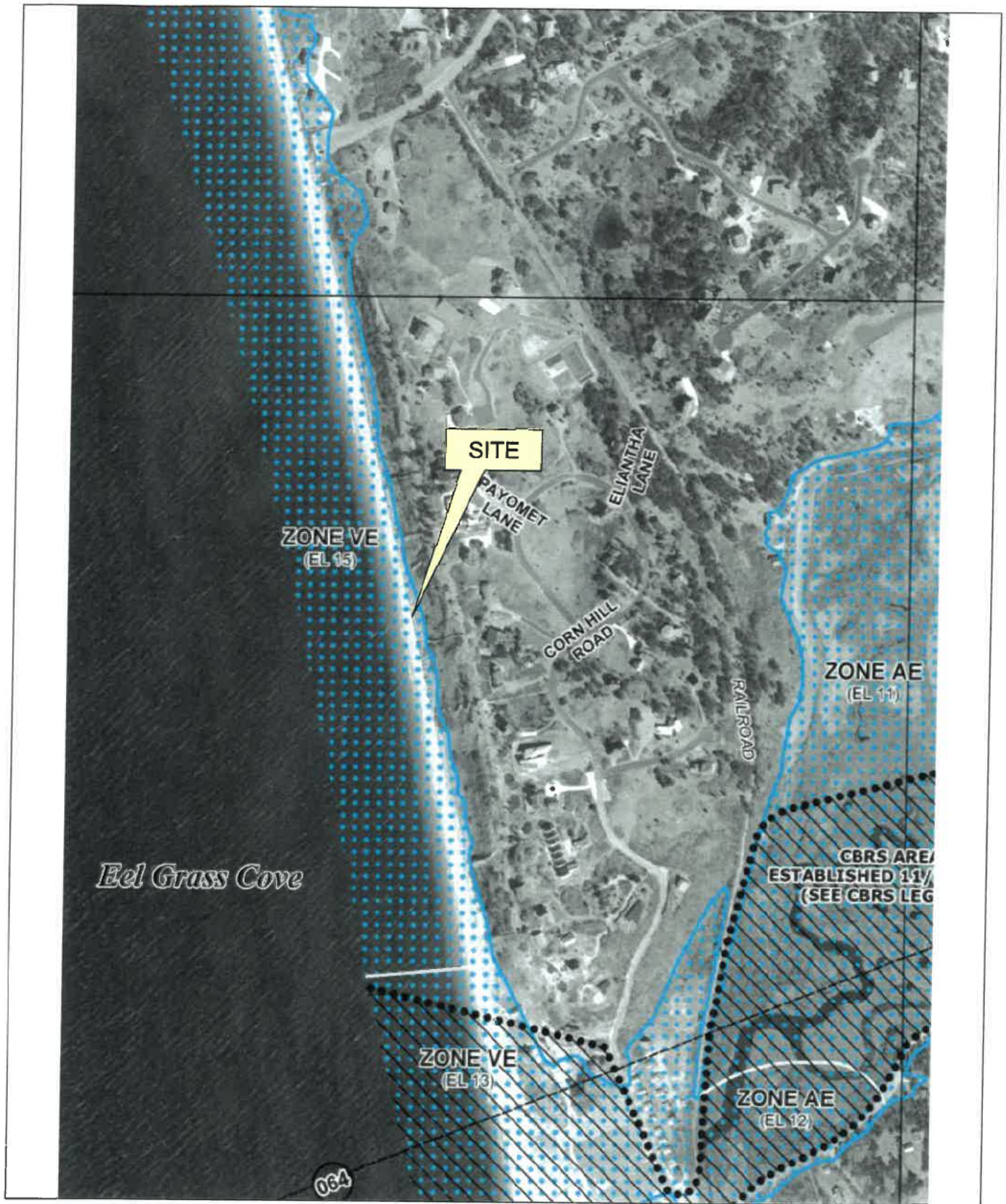

**FEMA F.I.R.M**  
**4 Payomet Lane, 23 Corn Hill Landing, 3 Corn Hill Path, 2 Corn Hill Path, 6 Corn Hill**  
**Landing, 4 Corn Hill Landing**  
**Truro, Massachusetts**

Source: FEMA Map 25001C0139J 07/16/2014

**N**  
**△**





**MCZM Shoreline Change Map**  
**4 Payomet Lane, 23 Corn Hill Landing, 3 Corn Hill Path, 2 Corn Hill Path, 6 Corn Hill Landing, 4 Corn Hill Landing**  
**Truro, Massachusetts**

**Source: Massachusetts Office of Coastal Zone Management**







**Priority Habitats of Rare Species, Estimated Habitat of Rare Wildlife  
& Certified Vernal Pools Map**  
 4 Payomet Lane, 23 Corn Hill Landing, 3 Corn Hill Path, 2 Corn Hill Path, 6 Corn Hill  
 Landing, 4 Corn Hill Landing  
 Truro, Massachusetts

Source: MassGIS Oliver Viewer





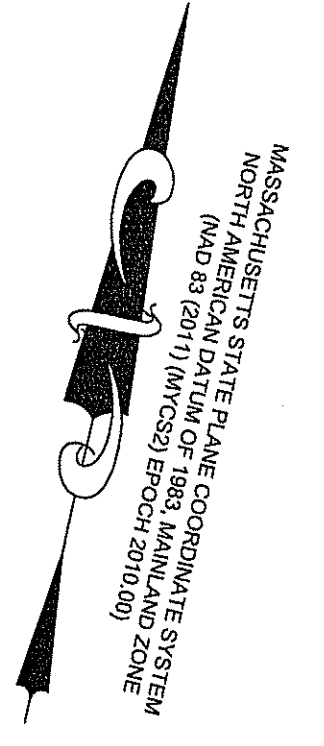

MASSACHUSETTS STATE PLANE COORDINATE SYSTEM  
 NORTH AMERICAN DATUM 83  
 (MAD 83) (2011) (NAD83) FIPS 4963, MASSACHUSETTS ZONE  
 (MAD 83) (2011) (NAD83) FIPS 4963, MASSACHUSETTS ZONE

F:\ISDKPROJ\C19878\C19878-001\19878-Ex-Con.dwg 6/6/2022 7:43 AM

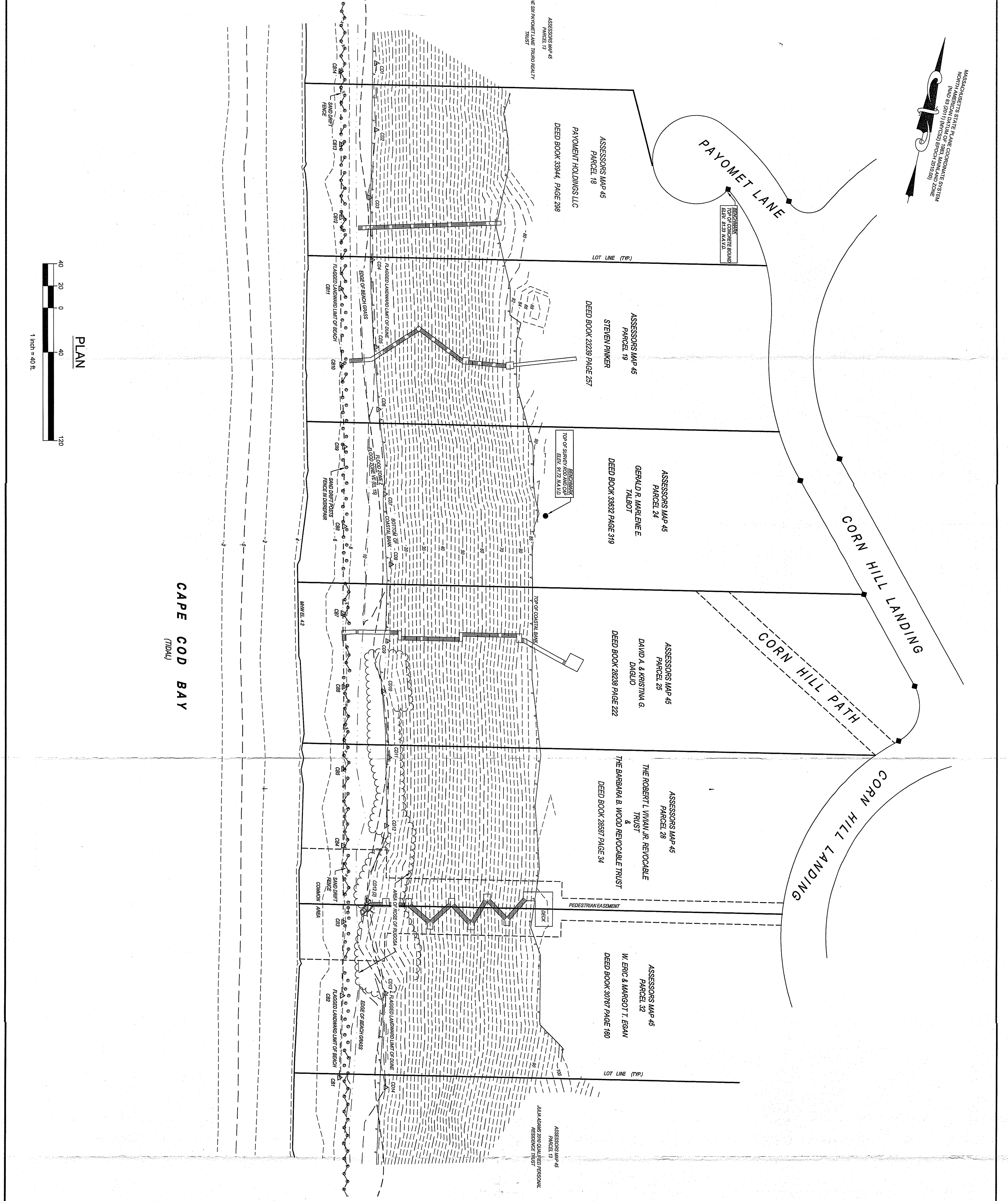

CAPE COD BAY  
(TIDAL)

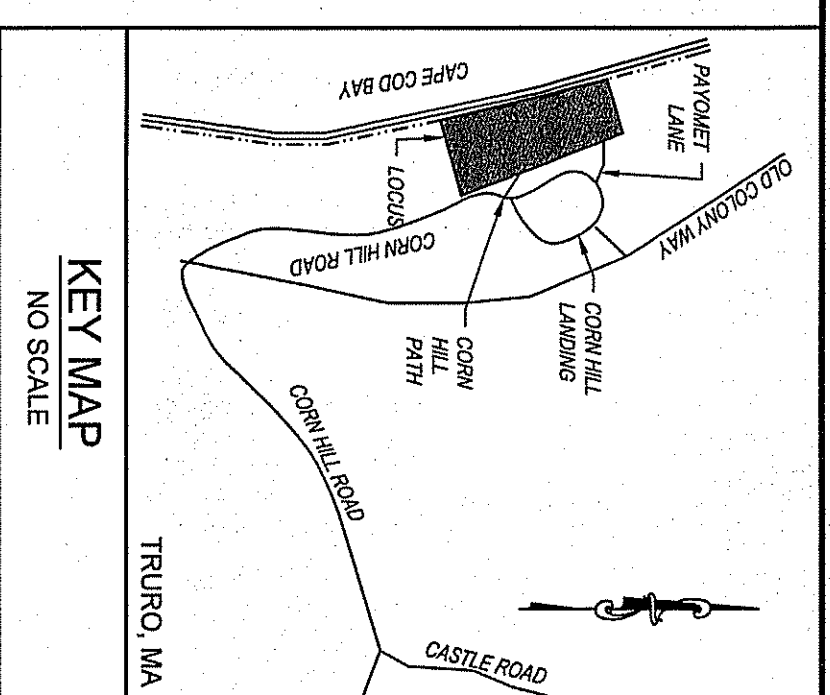
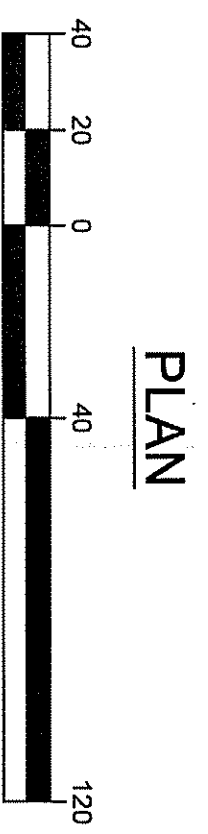

**REFERENCE:**

- ASSESSORS MAP 45, PARCELS 18, 19, 24, 25, 28, 32 & 39
- PLAN BOOK 321, PAGE 27
- PLAN BOOK 611, PAGE 26

**NOTES:**

1. VERTICAL DATUM IN U.S. SURVEY FEET REFERENCED TO THE NORTH AMERICAN VERTICAL DATUM OF 1988 (NAD83) BASED UPON THE HEXAGON SMARTNET TRIK NETWORK.
2. THIS PLAN IS THE RESULT OF AN INSTRUMENT SURVEY PERFORMED ON 04-21-2022 & 05-02-2022.
3. EXISTING UTILITIES, UNDERGROUND AND OVERHEAD, MAY EXIST IN ADDITION TO THE UTILITY INFORMATION SHOWN ON THESE PLANS. THIS PLAN MUST NOT BE USED TO LOCATE UNDERGROUND UTILITIES. CALL DIG SAFE AT 811 PRIOR TO STARTING ANY EXCAVATION.
4. FLOOD ZONE VE, VEI, V1, AND ZONE X SHOWN ON THIS DRAWING ARE A DIRECT REPRESENTATION OF THE GRAPHIC FLOOD ZONE BOUNDARIES SHOWN ON FEMA FIRM PANEL #25001C0138J EFFECTIVE JULY 16, 2014. PLEASE NOTE THAT SITE SPECIFIC FLOODPLAIN BOUNDARIES MAY VARY DUE TO DIFFERENT INTERPRETATIONS OF THESE BOUNDARIES. THESE BOUNDARIES WITHIN THE DESIGNATED COMMUNITY FLOODPLAIN MANAGERS AND/OR FEMA PRIOR TO SITING ANY PROPOSED STRUCTURES.
5. THIS SURVEY HAS BEEN PERFORMED WITHOUT THE BENEFIT OF A TITLE SEARCH AND MAY NOT REVEAL ANY FACTS THAT WOULD BE DISCLOSED BY ONE.
6. RIPARIAN BOUNDARIES ARE SUBJECT TO CHANGE DUE TO NATURAL CAUSES AND THAT THE BOUNDARY SHOWN HEREON MAY OR MAY NOT REPRESENT THE ACTUAL LOCATION OF THE LIMIT OF TITLE.

I HEREBY CERTIFY THAT THE CONDITIONS SHOWN HEREON ARE ON THE GROUND AS OF FIELD SURVEY 05-02-2022.  
 JUNE 4, 2022

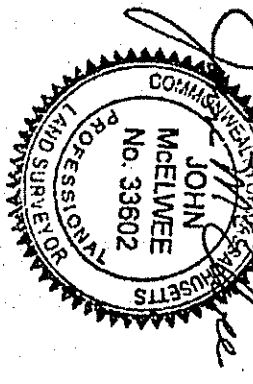

Conservation Commission  
 Truro, MA  
 03/30/2022

PROJECT 2 & 3 CORN HILL PATH, 4, 6 & 23 CORN HILL LANDING, 4 PAYOMET LANE TRURO, MA		ENVIRONMENTAL CONSULTING & RESTORATION, INC.	
SHEET TITLE LIMITED EXISTING CONDITIONS PLAN			
SCALE 1"=40'	DRAWING FILE C19878-EX-CON.dwg	DATE 05-11-2022	DRAWN BY MAP
CHECKED BY JDM			
PROJECT NO. C19878.00		1 OF 1 SHEETS	

C1.2.1



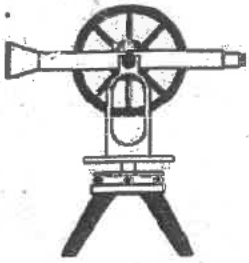

# J.C. ELLIS DESIGN COMPANY, INC.

SEPTIC SYSTEM DESIGN & ENGINEERING – SEPTIC INSPECTION –  
SITE PLANNING – WETLAND CONSULTATION & PERMITTING  
P.O. BOX 81, NORTH EASTHAM, MA 02651 PHONE 508-240-2220 FAX 508-240-2221  
EMAIL [jason@jccellisdesign.com](mailto:jason@jccellisdesign.com)

October 14, 2022

Truro Conservation Commission  
Town of Truro  
24 Town Hall Road  
Truro, MA 02666

**Re: Catherine Shainberg**  
**33 Black Pond Road, Truro, MA**  
**Assessor's Map 61, Parcel 12**

Dear Commissioners,

This letter accompanies a Notice of Intent and associated plans for a proposed addition to an existing dwelling. The work lies within a wetland resource area as defined in the Truro Conservation Regulations (100' buffer zone). In accordance with section II, chapter 1.05, e, 1 & 2 of the Truro Conservation Regulation, the applicant seeks a variance from section II, chapter 2.02. a 3 of the Truro Conservation Regulation to allow work within a defined wetland resource area.

Thank you for your attention to this request.  
Respectfully,

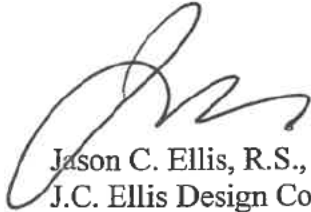

Jason C. Ellis, R.S., L.S.I.T.  
J.C. Ellis Design Co., Inc.



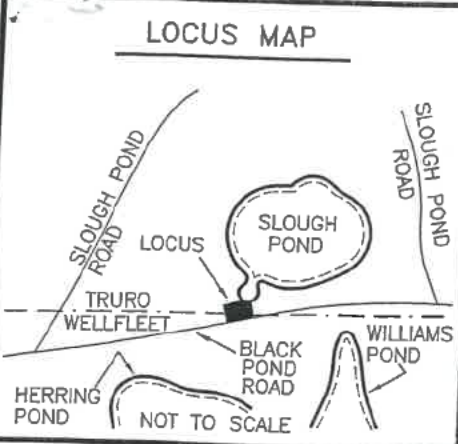

SURVEY PLAN REFERENCE:  
PLAN BOOK 240 PAGE 45

THIS PLAN REQUIRES CONSERVATION COMMISSION APPROVAL  
WORK LIMIT TO BE STAKED SILT FENCE AND STRAW WADDLE.  
ALL DISTURBED AREAS TO BE RESTORED WITH CONSERVATION  
GRASS SEED MIX.  
WORK TO BE STAGED OFF OF DRIVEWAY  
ALL EXCAVATION SPOILS AND DEMOLITION DEBRIS TO BE  
REMOVED FROM SITE DAILY.  
INSTALL GUTTERS, DOWNSPOUTS AND DRYWELLS TO ACCOMMODATE  
ROOF RUNOFF.

Conservation Commission  
TOWN OF TRURO  
OCT 14 2022

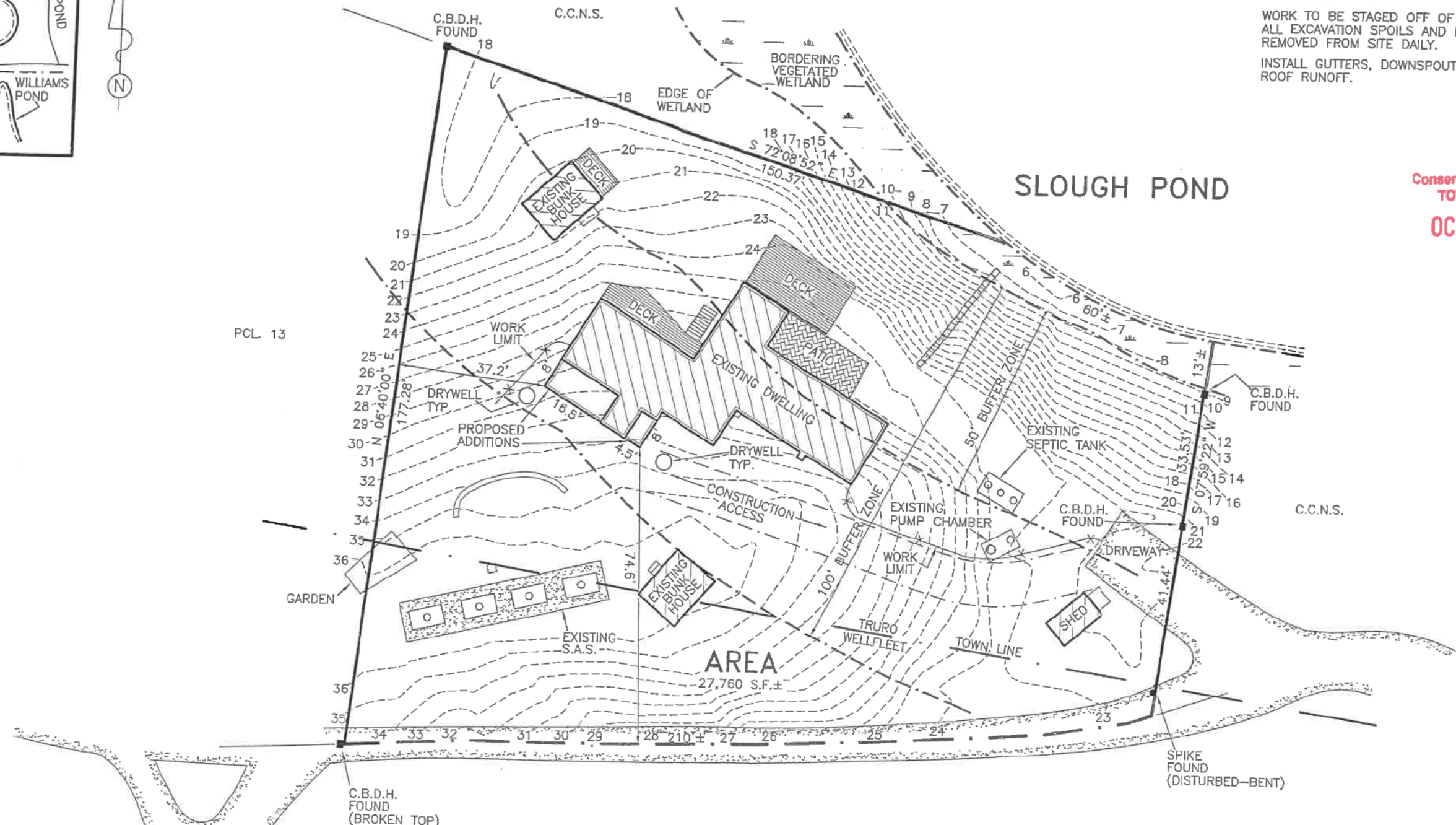

MICHAEL LADUE, P.L.S.  
LADUE LAND SURVEYING

J.C. ELLIS DESIGN



P.O. BOX 81  
NORTH EASTHAM, MA 02651  
(508)240-2220  
Email: jason@jcellisdesign.com

SITE PLAN

SUBJECT: <b>33 BLACK POND ROAD</b> TRURO, MA	
PREPARED FOR: <b>CATHERINE SHAINBERG</b> 73 FIFTH AVENUE, #8B NEW YORK, N.Y. 10003	
ASSESSOR'S MAP 61 PARCEL 12	SCALE: 1"=30'
DATE: SEPTEMBER 1, 2022	SHEET 1 OF 1



Conservation Commission  
TOWN OF TRURO  
OCT 18 2022

**Massachusetts Department of Environmental Protection**  
Bureau of Resource Protection - Wetlands  
**WPA Form 1 - Request for Determination of Applicability**  
Massachusetts Wetlands Protection Act M.G.L. c. 131, §40

Truro  
City/Town

**PAID**

**A. General Information**

**Important:**  
When filling out forms on the computer, use only the tab key to move your cursor - do not use the return key.



1. Applicant:

Ken Shapiro

Name

[Redacted]

Mailing Address

[Redacted]

City/Town

[Redacted]

Phone Number

[Redacted]

E-Mail Address

[Redacted]

State

[Redacted]

Zip Code

Fax Number (if applicable)

2. Representative (if any):

Firm

Kenneth Smith

Contact Name

25 Suffolk Ave

Mailing Address

West Yarmouth

City/Town

508.364.7515

Phone Number

[Redacted]

E-Mail Address

Ma

State

02673

Zip Code

Fax Number (if applicable)

**B. Determinations**

1. I request the Conservation Commission make the following determination(s). Check any that apply:  
Conservation Commission

- a. whether the **area** depicted on plan(s) and/or map(s) referenced below is an area subject to jurisdiction of the Wetlands Protection Act.
- b. whether the **boundaries** of resource area(s) depicted on plan(s) and/or map(s) referenced below are accurately delineated.
- c. whether the **work** depicted on plan(s) referenced below is subject to the Wetlands Protection Act.
- d. whether the area and/or work depicted on plan(s) referenced below is subject to the jurisdiction of any **municipal wetlands ordinance** or **bylaw** of:

Name of Municipality

- e. whether the following **scope of alternatives** is adequate for work in the Riverfront Area as depicted on referenced plan(s).



**WPA Form 1 - Request for Determination of Applicability**  
Massachusetts Wetlands Protection Act M.G.L. c. 131, §40

**C. Project Description**

1. a. Project Location (use maps and plans to identify the location of the area subject to this request):

405 Shore Rd	N. Truro
Street Address	City/Town
Map 10	Parcel #5
Assessors Map/Plat Number	Parcel/Lot Number

b. Area Description (use additional paper, if necessary):

Looking to install a 10' X 12" shed on the Northeast side of the property as marked on the plan attached.

c. Plan and/or Map Reference(s):

Site plan with spot marked for location of 10 X 12 Shed set on blocks	10/12/22
Title	Date
_____	_____
Title	Date
_____	_____
Title	Date
_____	_____

2. a. Work Description (use additional paper and/or provide plan(s) of work, if necessary):

\_\_\_\_\_



**WPA Form 1 - Request for Determination of Applicability**

Massachusetts Wetlands Protection Act M.G.L. c. 131, §40

**C. Project Description (cont.)**

b. Identify provisions of the Wetlands Protection Act or regulations which may exempt the applicant from having to file a Notice of Intent for all or part of the described work (use additional paper, if necessary).

Free standing shed set on block. its not a perment structure that is less than 200 sq ft.

3. a. If this application is a Request for Determination of Scope of Alternatives for work in the Riverfront Area, indicate the one classification below that best describes the project.

- Single family house on a lot recorded on or before 8/1/96
- Single family house on a lot recorded after 8/1/96
- Expansion of an existing structure on a lot recorded after 8/1/96
- Project, other than a single-family house or public project, where the applicant owned the lot before 8/7/96
- New agriculture or aquaculture project
- Public project where funds were appropriated prior to 8/7/96
- Project on a lot shown on an approved, definitive subdivision plan where there is a recorded deed restriction limiting total alteration of the Riverfront Area for the entire subdivision
- Residential subdivision; institutional, industrial, or commercial project
- Municipal project
- District, county, state, or federal government project
- Project required to evaluate off-site alternatives in more than one municipality in an Environmental Impact Report under MEPA or in an alternatives analysis pursuant to an application for a 404 permit from the U.S. Army Corps of Engineers or 401 Water Quality Certification from the Department of Environmental Protection.

b. Provide evidence (e.g., record of date subdivision lot was recorded) supporting the classification above (use additional paper and/or attach appropriate documents, if necessary.)



# WPA Form 1- Request for Determination of Applicability

Massachusetts Wetlands Protection Act M.G.L. c. 131, §40

## D. Signatures and Submittal Requirements

I hereby certify under the penalties of perjury that the foregoing Request for Determination of Applicability and accompanying plans, documents, and supporting data are true and complete to the best of my knowledge.

I further certify that the property owner, if different from the applicant, and the appropriate DEP Regional Office were sent a complete copy of this Request (including all appropriate documentation) simultaneously with the submittal of this Request to the Conservation Commission.

Failure by the applicant to send copies in a timely manner may result in dismissal of the Request for Determination of Applicability.

Name and address of the property owner:

\_\_\_\_\_  
Name  
\_\_\_\_\_  
Mailing Address  
\_\_\_\_\_  
City/Town  
\_\_\_\_\_  
State  
\_\_\_\_\_  
Zip Code

Signatures:

I also understand that notification of this Request will be placed in a local newspaper at my expense in accordance with Section 10.05(3)(b)(1) of the Wetlands Protection Act regulations.

  
\_\_\_\_\_  
Signature of Applicant

10/13/22  
\_\_\_\_\_  
Date

\_\_\_\_\_  
Signature of Representative (if any)

\_\_\_\_\_  
Date



NOTE 1: HEAVY DUTY REINFORCEMENT REQUIRED FOR 1 BEDROOM EACH AREA.

THIS PLAN REQUIRES CONSERVATION COMMISSION APPROVAL.

ENTIRE PROPERTY LIES WITHIN A BARBER BEACH COASTAL DUNE RESERVE.

WORK LIMITS TO BE STAGED REORD SNOW FENCING.

WORK LIMITS TO BE LIMIT OF EROSION CONTROL ACTIVITY.

DRIVEWAY CONSTRUCTION: PERVIOUS BASE MATERIAL.

2-3" OF COMPACTED GRANULAR FINISH

2-3" OF COMPACTED ASPHALT BASE MATERIAL.

2-3" OF COMPACTED GRANULAR FINISH

2-3" OF COMPACTED ASPHALT FINISH

2-3" OF COMPACTED GRANULAR FINISH

2-3" OF COMPACTED ASPHALT FINISH

2-3" OF COMPACTED GRANULAR FINISH

2-3" OF COMPACTED ASPHALT FINISH

2-3" OF COMPACTED GRANULAR FINISH

2-3" OF COMPACTED ASPHALT FINISH

2-3" OF COMPACTED GRANULAR FINISH

2-3" OF COMPACTED ASPHALT FINISH

2-3" OF COMPACTED GRANULAR FINISH

2-3" OF COMPACTED ASPHALT FINISH

2-3" OF COMPACTED GRANULAR FINISH

2-3" OF COMPACTED ASPHALT FINISH

2-3" OF COMPACTED GRANULAR FINISH

2-3" OF COMPACTED ASPHALT FINISH

2-3" OF COMPACTED GRANULAR FINISH

2-3" OF COMPACTED ASPHALT FINISH

2-3" OF COMPACTED GRANULAR FINISH

2-3" OF COMPACTED ASPHALT FINISH

2-3" OF COMPACTED GRANULAR FINISH

2-3" OF COMPACTED ASPHALT FINISH

2-3" OF COMPACTED GRANULAR FINISH

2-3" OF COMPACTED ASPHALT FINISH

2-3" OF COMPACTED GRANULAR FINISH

2-3" OF COMPACTED ASPHALT FINISH

2-3" OF COMPACTED GRANULAR FINISH

2-3" OF COMPACTED ASPHALT FINISH

2-3" OF COMPACTED GRANULAR FINISH

2-3" OF COMPACTED ASPHALT FINISH

2-3" OF COMPACTED GRANULAR FINISH

2-3" OF COMPACTED ASPHALT FINISH

2-3" OF COMPACTED GRANULAR FINISH

2-3" OF COMPACTED ASPHALT FINISH

2-3" OF COMPACTED GRANULAR FINISH

2-3" OF COMPACTED ASPHALT FINISH

2-3" OF COMPACTED GRANULAR FINISH

2-3" OF COMPACTED ASPHALT FINISH

2-3" OF COMPACTED GRANULAR FINISH

2-3" OF COMPACTED ASPHALT FINISH

2-3" OF COMPACTED GRANULAR FINISH

2-3" OF COMPACTED ASPHALT FINISH

2-3" OF COMPACTED GRANULAR FINISH

2-3" OF COMPACTED ASPHALT FINISH

2-3" OF COMPACTED GRANULAR FINISH

2-3" OF COMPACTED ASPHALT FINISH

2-3" OF COMPACTED GRANULAR FINISH

2-3" OF COMPACTED ASPHALT FINISH

2-3" OF COMPACTED GRANULAR FINISH

2-3" OF COMPACTED ASPHALT FINISH

2-3" OF COMPACTED GRANULAR FINISH

2-3" OF COMPACTED ASPHALT FINISH

2-3" OF COMPACTED GRANULAR FINISH

2-3" OF COMPACTED ASPHALT FINISH

2-3" OF COMPACTED GRANULAR FINISH

2-3" OF COMPACTED ASPHALT FINISH

2-3" OF COMPACTED GRANULAR FINISH

2-3" OF COMPACTED ASPHALT FINISH

2-3" OF COMPACTED GRANULAR FINISH

2-3" OF COMPACTED ASPHALT FINISH

2-3" OF COMPACTED GRANULAR FINISH

V/E 6

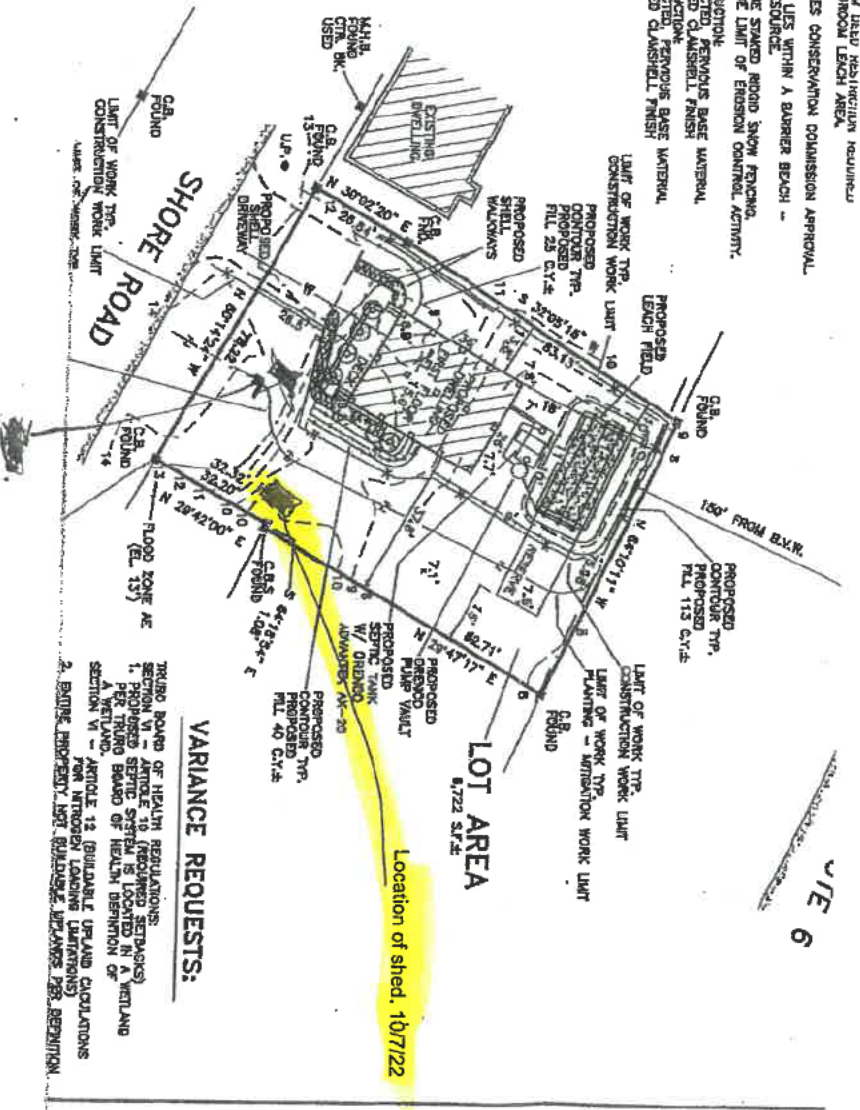

**VARIANCE REQUESTS:**

- 1. THIRD BOARD OF HEALTH REGULATIONS: SECTION VI - ARTICLE 10 (REGULATED SEPTICAGE) - PROPOSED SEPTIC SYSTEM IS LOCATED IN A WETLAND A VIOLATION BOARD OF HEALTH DEFINITION OF SECTION VI - ARTICLE 12 (BUILDING LAYOUT REGULATIONS) FROM NITROGEN LEAKING DURING CONSTRUCTION.
- 2. EXISTING EMPLOYMENT, LOT DIMENSIONS, 8722S, 288, 289, 290, 291, 292, 293, 294, 295, 296, 297, 298, 299, 300, 301, 302, 303, 304, 305, 306, 307, 308, 309, 310, 311, 312, 313, 314, 315, 316, 317, 318, 319, 320, 321, 322, 323, 324, 325, 326, 327, 328, 329, 330, 331, 332, 333, 334, 335, 336, 337, 338, 339, 340, 341, 342, 343, 344, 345, 346, 347, 348, 349, 350, 351, 352, 353, 354, 355, 356, 357, 358, 359, 360, 361, 362, 363, 364, 365, 366, 367, 368, 369, 370, 371, 372, 373, 374, 375, 376, 377, 378, 379, 380, 381, 382, 383, 384, 385, 386, 387, 388, 389, 390, 391, 392, 393, 394, 395, 396, 397, 398, 399, 400, 401, 402, 403, 404, 405, 406, 407, 408, 409, 410, 411, 412, 413, 414, 415, 416, 417, 418, 419, 420, 421, 422, 423, 424, 425, 426, 427, 428, 429, 430, 431, 432, 433, 434, 435, 436, 437, 438, 439, 440, 441, 442, 443, 444, 445, 446, 447, 448, 449, 450, 451, 452, 453, 454, 455, 456, 457, 458, 459, 460, 461, 462, 463, 464, 465, 466, 467, 468, 469, 470, 471, 472, 473, 474, 475, 476, 477, 478, 479, 480, 481, 482, 483, 484, 485, 486, 487, 488, 489, 490, 491, 492, 493, 494, 495, 496, 497, 498, 499, 500, 501, 502, 503, 504, 505, 506, 507, 508, 509, 510, 511, 512, 513, 514, 515, 516, 517, 518, 519, 520, 521, 522, 523, 524, 525, 526, 527, 528, 529, 530, 531, 532, 533, 534, 535, 536, 537, 538, 539, 540, 541, 542, 543, 544, 545, 546, 547, 548, 549, 550, 551, 552, 553, 554, 555, 556, 557, 558, 559, 560, 561, 562, 563, 564, 565, 566, 567, 568, 569, 570, 571, 572, 573, 574, 575, 576, 577, 578, 579, 580, 581, 582, 583, 584, 585, 586, 587, 588, 589, 590, 591, 592, 593, 594, 595, 596, 597, 598, 599, 600, 601, 602, 603, 604, 605, 606, 607, 608, 609, 610, 611, 612, 613, 614, 615, 616, 617, 618, 619, 620, 621, 622, 623, 624, 625, 626, 627, 628, 629, 630, 631, 632, 633, 634, 635, 636, 637, 638, 639, 640, 641, 642, 643, 644, 645, 646, 647, 648, 649, 650, 651, 652, 653, 654, 655, 656, 657, 658, 659, 660, 661, 662, 663, 664, 665, 666, 667, 668, 669, 670, 671, 672, 673, 674, 675, 676, 677, 678, 679, 680, 681, 682, 683, 684, 685, 686, 687, 688, 689, 690, 691, 692, 693, 694, 695, 696, 697, 698, 699, 700, 701, 702, 703, 704, 705, 706, 707, 708, 709, 710, 711, 712, 713, 714, 715, 716, 717, 718, 719, 720, 721, 722, 723, 724, 725, 726, 727, 728, 729, 730, 731, 732, 733, 734, 735, 736, 737, 738, 739, 740, 741, 742, 743, 744, 745, 746, 747, 748, 749, 750, 751, 752, 753, 754, 755, 756, 757, 758, 759, 760, 761, 762, 763, 764, 765, 766, 767, 768, 769, 770, 771, 772, 773, 774, 775, 776, 777, 778, 779, 780, 781, 782, 783, 784, 785, 786, 787, 788, 789, 790, 791, 792, 793, 794, 795, 796, 797, 798, 799, 800, 801, 802, 803, 804, 805, 806, 807, 808, 809, 810, 811, 812, 813, 814, 815, 816, 817, 818, 819, 820, 821, 822, 823, 824, 825, 826, 827, 828, 829, 830, 831, 832, 833, 834, 835, 836, 837, 838, 839, 840, 841, 842, 843, 844, 845, 846, 847, 848, 849, 850, 851, 852, 853, 854, 855, 856, 857, 858, 859, 860, 861, 862, 863, 864, 865, 866, 867, 868, 869, 870, 871, 872, 873, 874, 875, 876, 877, 878, 879, 880, 881, 882, 883, 884, 885, 886, 887, 888, 889, 890, 891, 892, 893, 894, 895, 896, 897, 898, 899, 900, 901, 902, 903, 904, 905, 906, 907, 908, 909, 910, 911, 912, 913, 914, 915, 916, 917, 918, 919, 920, 921, 922, 923, 924, 925, 926, 927, 928, 929, 930, 931, 932, 933, 934, 935, 936, 937, 938, 939, 940, 941, 942, 943, 944, 945, 946, 947, 948, 949, 950, 951, 952, 953, 954, 955, 956, 957, 958, 959, 960, 961, 962, 963, 964, 965, 966, 967, 968, 969, 970, 971, 972, 973, 974, 975, 976, 977, 978, 979, 980, 981, 982, 983, 984, 985, 986, 987, 988, 989, 990, 991, 992, 993, 994, 995, 996, 997, 998, 999, 1000.

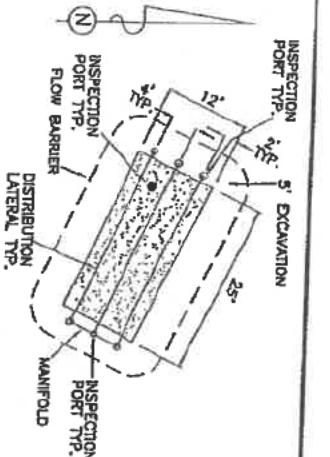
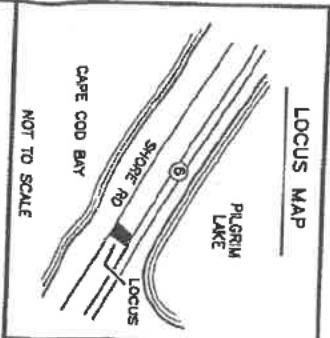

S.A.S. DETAIL

SURVEY PLAN REFERENCES:  
 PLAN BOOK 303 PAGE 75  
 PLAN BOOK 489 PAGE 74

PROPERTY OWNER AND CONTRACTORS TO VERIFY ALL WATER LINES AND GAS UTILITIES ON PROPERTY.

\*NOTE: 1 BEDROOM: DEED RESTRICTION REQUIRED FOR 1 BEDROOM LEACH AREA.

THIS PLAN REQUIRES CONSERVATION COMMISSION APPROVAL  
 ENTIRE PROPERTY LIES WITHIN A BARRIER BEACH - COASTAL DUNE RESOURCE.

WORK LIMITS TO BE STAGED RIDGID SNOW FENCING. WORK LIMITS TO BE LIMIT OF EROSION CONTROL ACTIVITY.

DRIVEWAY CONSTRUCTION:  
 6'-8" OF COMPACTED, PERVIOUS BASE MATERIAL.  
 2'-3" OF CRUSHED CLAMSHELL FINISH  
 3" OF GRANULATED PERVIOUS BASE MATERIAL.  
 2'-3" OF CRUSHED CLAMSHELL FINISH

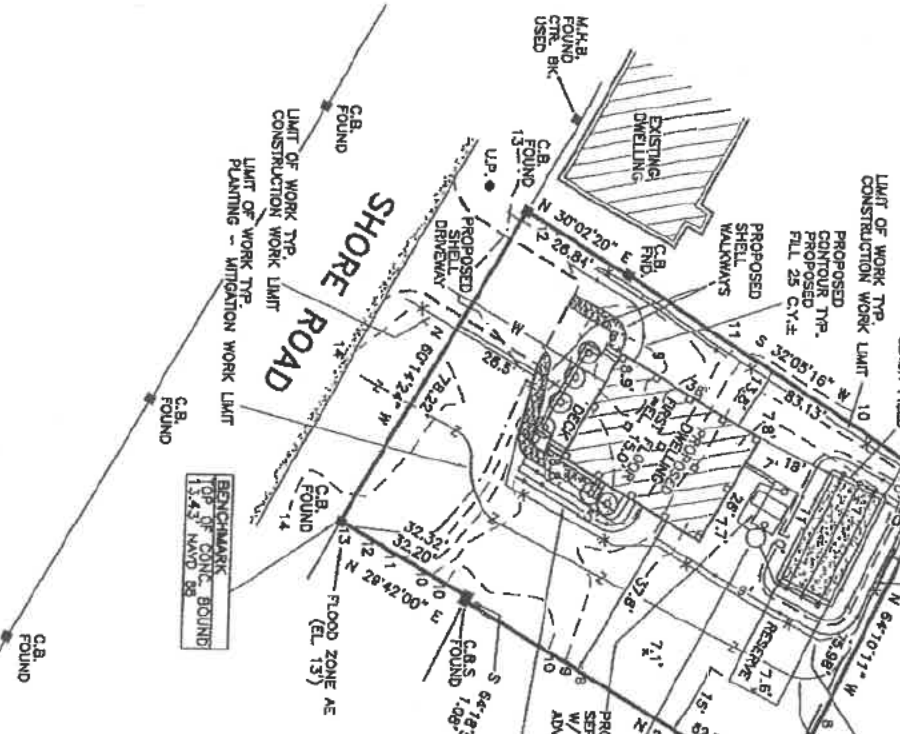

VARIANCE REQUESTS:

- TRURO BOARD OF HEALTH REGULATIONS:
- SECTION VI - ARTICLE 10 (REQUIRED STRIPBACKS)
- 1. PROPOSED SEPTIC SYSTEM IS LOCATED IN A WETLAND PER TRURO BOARD OF HEALTH DEFINITION OF A WETLAND.
- SECTION VI - ARTICLE 12 (BUILDABLE UPLAND CALCULATIONS FOR NITROGEN LOADING LIMITATIONS)
- 2. ENTIRE PROPERTY NOT BUILDABLE UPLANDS PER DEFINITION AND ENTIRE LOT AREA USED FOR LOT AREA CALCULATIONS.
- SECTION VI - ARTICLE 14 (NITROGEN LOADING LIMITATIONS)
- 3. PROPOSED SEPTIC SYSTEM IS DESIGNED FOR A 1 BEDROOM HOME ON A 8,722 S.F. LOT.
- SECTION VI - ARTICLE 9(2) (INNOVATIVE/ALTERNATIVE TECHNOLOGY - STANDARDS)
- 4. PROPOSED INNOVATIVE/ALTERNATIVE TECHNOLOGY SEPTIC SYSTEM TO BE USED IN PROVISIONAL USE SITUATION.

CAPE COD BAY



JASON C. ELLS, R.S.

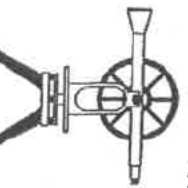

J.C. ELLS DESIGN

P.O. BOX 81  
 NORTH EASTHAM, MA 02651  
 (508)240-2220  
 Jason@jcellsdsgn.com

SEPTIC SYSTEM DESIGN PLAN

SUBJECT: 405 SHORE ROAD  
 TRURO, MA

PREPARED FOR: KENNETH SHAPIRO  
 460 HILLSIDE AVENUE  
 NEEDHAM, MA 02494

ASSESSOR'S MAP 10, PARCEL 5	SCALE: 1"=30'
DATE: JANUARY 18, 2018	SHEET 1 OF 3
REV: APRIL 27, 2020	

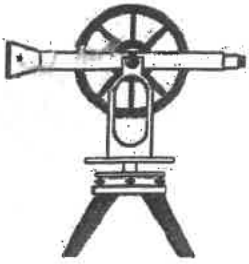

# J.C. ELLIS DESIGN COMPANY, INC.

SEPTIC SYSTEM DESIGN & ENGINEERING – SEPTIC INSPECTION –  
SITE PLANNING – WETLAND CONSULTATION & PERMITTING  
P.O. BOX 81, NORTH EASTHAM, MA 02651 PHONE 508-240-2220 FAX 508-240-2221  
EMAIL [jason@jcellisdesign.com](mailto:jason@jcellisdesign.com)

## Notification to Abutters Under the Massachusetts Wetland Protection Act & Truro Conservation Regulation

October 13, 2022

**RE: Request for Determination of Applicability**

Abigail Swan & Robert Galligan  
5 Joseph's Road  
Truro, MA  
Assessor's Map 46, Parcel 25

In accordance with the MA Wetlands Protection Act and the Truro Wetlands Bylaw, you are hereby notified that Abigail Swan & Robert Galligan have filed a Request for Determination of Applicability with the Truro Conservation Commission regarding proposed work, on the above-referenced property, which lies within an area subject to regulation under the MA Wetlands Protection Act and the local Wetland Protection Bylaw.

Specifically, the proposed work consists of the installation of a new septic tank, Orenco Advantex system and pump vault, within the 100' buffer zone of a Bordering Vegetated Wetland and flood zone.

Copies of the RDA and project plans may be examined at the Truro Conservation Department, located at 24 Town Hall Road, during regular business hours.

A public hearing, regarding the proposed work described above, will be held by the Truro Conservation Commission on November 7, 2022 at 5:00 P.M at the Truro Town Hall. Should you be interested in attending the public hearing, you should contact the Conservation Department for confirmation of the date, time and place of the public hearing at 508-349-7004 x31.

Sincerely,

Jason C. Ellis, R.S., L.S.I.T.

cc: abutters  
file

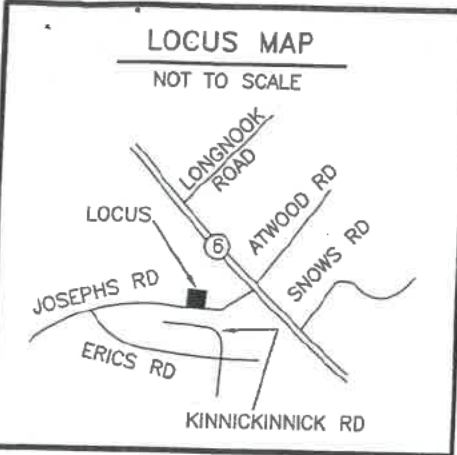

THIS PLAN REQUIRES CONSERVATION COMMISSION APPROVAL.  
 WORK LIMIT TO BE STAKED SILT FENCE AND STRAW WADDLE.  
 DISTURBED AREAS TO BE PLANTED WITH CONSERVATION  
 GRASS SEED MIXTURE. EROSION CONTROL FABRIC TO  
 BE INSTALLED ON SLOPES TO PREVENT EROSION IN  
 DISTURBED AREAS.

Conservation Commission  
 TOWN OF TRURO  
 OCT 14 2022

**VARIANCE REQUESTS:**

- TRURO BOARD OF HEALTH REGULATIONS:  
 SECTION VI - ARTICLE 9
1. PROPOSED SEPTIC TANK LOCATED WITHIN 100' OF WETLAND (67')  
 (100' REQUIRED, 67' PROVIDED, 33' VARIANCE REQUESTED)
  2. PROPOSED PUMP VAULT LOCATED WITHIN 100' OF WETLAND (77')  
 (100' REQUIRED, 77' PROVIDED, 23' VARIANCE REQUESTED)
  3. PROPOSED S.A.S. LOCATED WITHIN 150' OF WETLAND (102')  
 (150' REQUIRED, 102' PROVIDED, 48' VARIANCE REQUESTED)  
 310 CMR 15.211
  4. PROPOSED S.A.S. LOCATED WITHIN 10' OF LOT LINE, PCL. 24 (6')  
 (10' REQUIRED, 6' PROVIDED, 4' VARIANCE REQUESTED)
  5. PROPOSED S.A.S. LOCATED WITHIN 10' OF LOT LINE, ROAD (5')  
 (10' REQUIRED, 5' PROVIDED, 5' VARIANCE REQUESTED)  
 310 CMR 15.248
  6. NO RESERVE AREA PROVIDED.

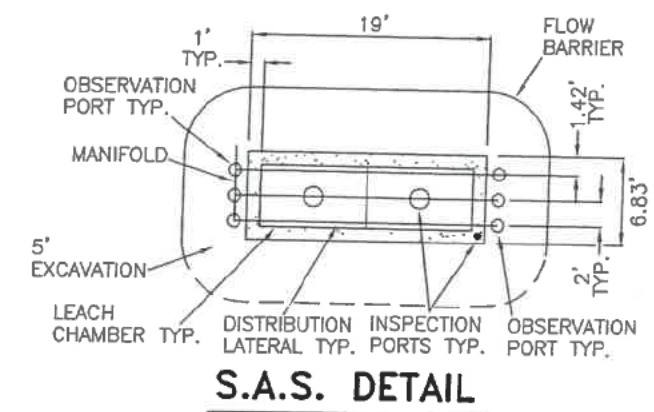
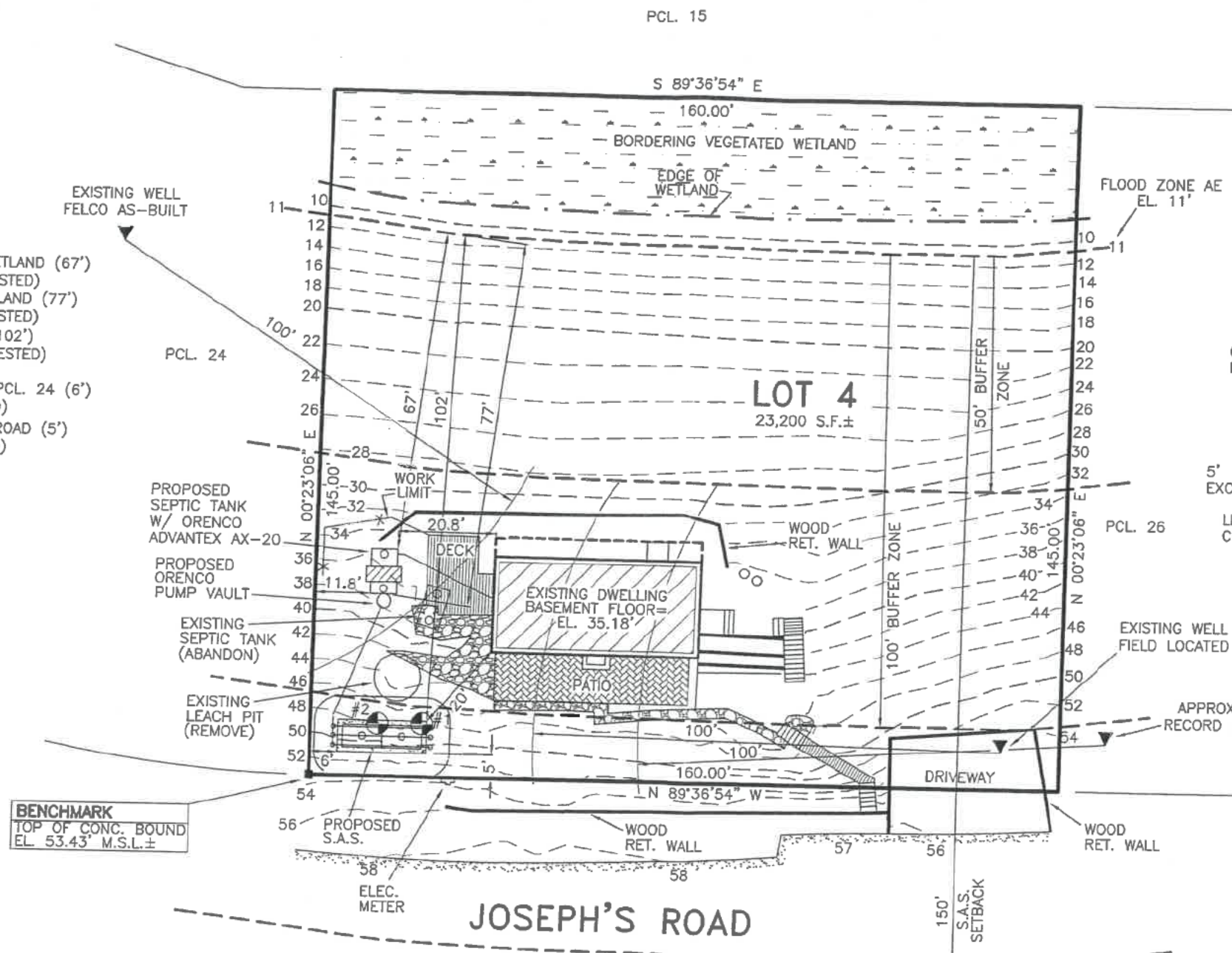

**BENCHMARK**  
 TOP OF CONC. BOUND  
 EL. 53.43' M.S.L.±

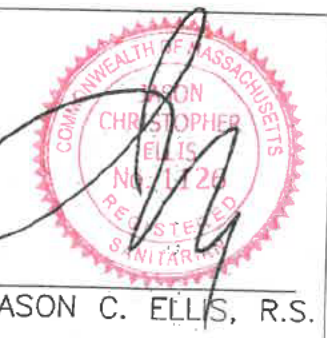

SURVEY PLAN REFERENCE:  
 PLAN BOOK 246 PAGE 86  
 THIS PLAN IS FOR SEPTIC SYSTEM  
 DESIGN PURPOSES ONLY.  
 THIS PLAN IS NOT FOR BOUNDARY  
 DETERMINATION.  
 PROPERTY OWNER AND  
 CONTRACTORS TO VERIFY  
 ALL WATER LINES AND GAS  
 UTILITIES ON PROPERTY.

J.C. ELLIS DESIGN

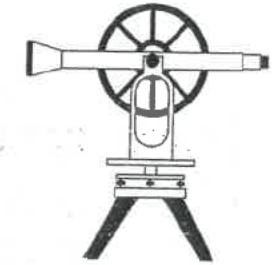

P.O. BOX 81  
 NORTH EASTHAM, MA 02651  
 (508)240-2220  
 Email: jason@jcellisdesign.com

**SEPTIC SYSTEM UPGRADE PLAN**

SUBJECT: <b>5 JOSEPH'S ROAD</b> TRURO, MA	
PREPARED FOR: <b>ROBERT GALLIGAN &amp; ABIGAIL SWAN</b> P.O. BOX 175 TRURO, MA 02666-0175	
ASSESSOR'S MAP 46 PARCEL 25	SCALE: 1"=30'
DATE: SEPTEMBER 25, 2022	SHEET 1 OF 3



# SECTION DETAIL - COMPONENTS

NOT TO SCALE

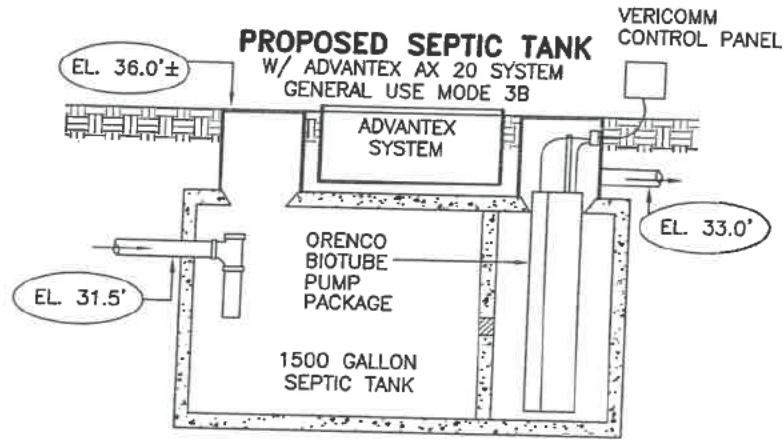
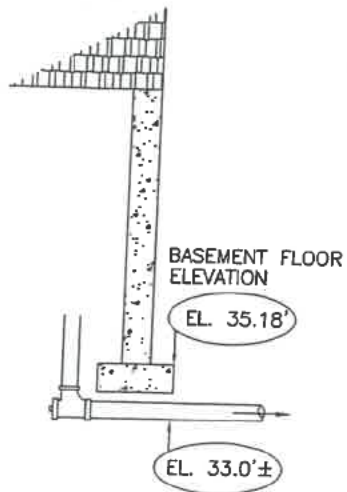

CONTRACTOR TO INSTALL ADVANTEX SYSTEM DESIGNER'S AND MANUFACTURER'S SPECIFICATIONS.  
CONTRACTOR MAY USE AN ORENCO FIBERGLASS SEPTIC TANK IN SUBSTITUTION FOR CONCRETE TANK.

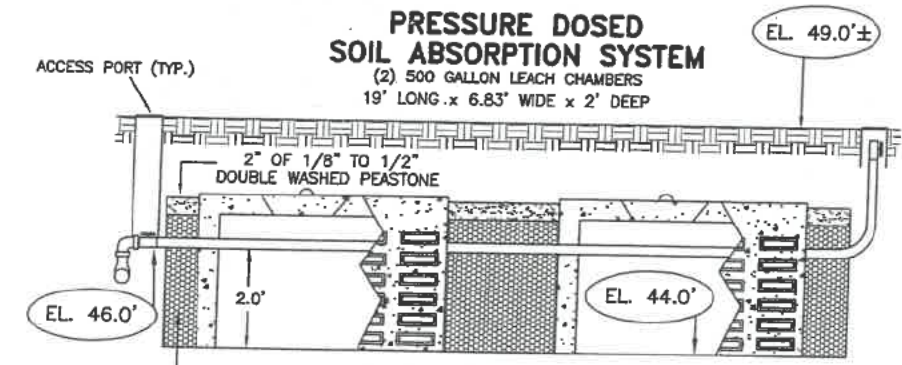
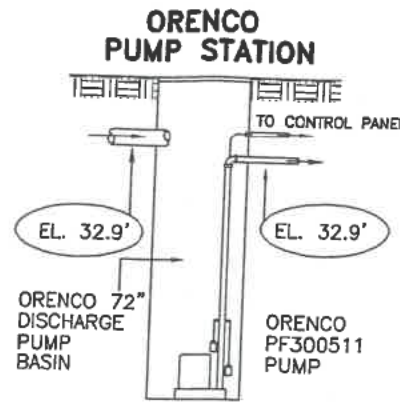

LEACH AREA DESIGN DETAILS:  
LATERALS: (3) 1" PVC PRESSURE PIPE  
MANIFOLD: (1) 2" PVC PRESSURE PIPE  
PERFORATION SHIELD: ORIFICE CAPS  
PERFORATIONS: 1/8" @ 24" O.C. (STAGGER BETWEEN LATERALS)  
PITCH: PROVIDE 1/4" PITCH MIN. BACK TO PUMP VAULT

## DESIGN CALCULATIONS

### FLOW RATE:

3 BEDROOM DWELLING = 330 G/P/D REQUIRED  
(110 G/P/D PER BEDROOM x 3 BEDROOMS)  
NO GARBAGE GRINDER ALLOWED

### SEPTIC TANK:

330 G/P/D x 2 = 660 G/P/D REQUIRED  
USE 1500 GALLON SEPTIC TANK

### SOIL ABSORPTION SYSTEM:

PERC RATE = <2 MIN/IN - CLASS I SOIL  
SIDEWALL = (19 + 6.83)(2)(2) = 103.32 S.F.  
BOTTOM: (19)(6.83) = 129.77 S.F.  
(103.32 + 129.77)(0.74) = 172.48 G/P/D PROVIDED  
USE: (2) 500 GALLON LEACH CHAMBERS W/ 2' OF STONE AS SHOWN IN DETAIL.

48% REDUCTION IN REQUIRED SIZE OF S.A.S. PROVIDED PER DEP GENERAL USE APPROVAL.

## NOTES

- ALL PRECAST COMPONENTS TO BE H-10 RATED. ALL COMPONENTS WITH ANY ANTICIPATED VEHICULAR TRAFFIC TO BE H-20 RATED.
- ELEVATION DATUM IS FROM GIS (M.S.L.).
- MUNICIPAL WATER IS NOT AVAILABLE.
- ALL CONSTRUCTION TO CONFORM WITH 310 CMR 15.000 AND ALL OTHER APPLICABLE LOCAL, STATE AND FEDERAL CODES AND REGULATIONS.
- INSTALLER/CONTRACTOR TO REVIEW & VERIFY ALL ELEVATIONS AND DETAILS AND REPORT ANY DISCREPANCIES TO DESIGNER PRIOR TO CONSTRUCTION OR ASSUME ALL RESPONSIBILITY.
- INSTALLER/CONTRACTOR IS RESPONSIBLE FOR MAINTAINING SAFE WORK AREA, VERIFYING ALL UTILITIES AND NOTIFYING DIG SAFE PRIOR TO CONSTRUCTION.
- ANY CHANGES TO OR DEVIATIONS FROM THIS PLAN MUST BE APPROVED IN WRITING BY J.C. ELLIS DESIGN CO. AND BOARD OF HEALTH.
- FINISH COVER OVER COMPONENTS IS NOT TO EXCEED 3' PER 310 CMR 15.000.
- ALL COMPONENTS TO BE PROVIDED WITH WATERTIGHT ACCESS PORTS WITHIN 6" OF FINISH GRADE.
- ALL SEPTIC TANKS, DISTRIBUTION BOXES AND PIPING TO BE INSTALLED WATERTIGHT.
- NO KNOWN WELLS EXIST WITHIN 100' OF PROPOSED LEACH AREA.
- SUITABLE SOIL CONDITIONS TO BE VERIFIED IN AREA OF PROPOSED LEACH AREA AT TIME OF INSTALLATION.
- LEACH AREA TO BE PROVIDED WITH AT LEAST ONE INSPECTION PORT CONSISTING OF A PERFORATED FOUR INCH PIPE PLACED VERTICALLY DOWN INTO THE STONE TO THE NATURALLY OCCURRING SOIL OR SAND FILL BELOW THE STONE. THE PIPE SHALL BE CAPPED WITH A SCREW TYPE CAP AND ACCESSIBLE WITHIN 3" OF GRADE.
- EXCAVATE ALL UNSUITABLE SOIL, ONLY AS NECESSARY, 5' AROUND AND UNDER S.A.S. DOWN TO C LAYER AND REPLACE WITH CLEAN MEDIUM SAND.
- INSTALL 40 MIL POLY FLOW BARRIER AS SHOWN AROUND S.A.S. FROM EL. 47.5' DOWN TO EL. 40.0'.
- CONTRACTOR TO LOCATE AND VERIFY ALL BUILDING SEWER LOCATIONS AND ELEVATIONS PRIOR TO CONSTRUCTION.

## DEEP HOLE DATA

PERFORMED BY: JASON C. ELLIS, R.S., S.E.  
WITNESSED BY: AROZANA DAVIS, TRURO B.O.H.  
TEST DATE: SEPTEMBER 23, 2022

Conservation Commission  
TOWN OF TRURO  
OCT 14 2022

#1		#2	
DEPTH	ELEV.	DEPTH	ELEV.
0.00'	47.8'	0.00'	48.1'
0.75'	47.05'	0.66'	47.44'
1.83'	45.97'	2.33'	45.77'
10.0'	37.8'	10.0'	38.1'
NO WATER ENCOUNTERED		NO WATER ENCOUNTERED	

## SEPTIC SYSTEM UPGRADE PLAN

SUBJECT:

5 JOSEPH'S ROAD  
TRURO, MA

PREPARED FOR:

ROBERT GALLIGAN & ABIGAIL SWAN  
P.O. BOX 175  
TRURO, MA 02666-0175

ASSESSOR'S  
MAP 46 PARCEL 25

DATE: SEPTEMBER 25, 2022

SHEET 2 OF 3

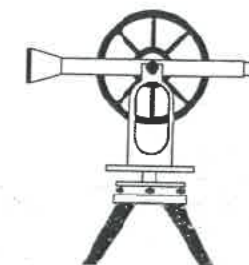

J.C. ELLIS DESIGN  
P.O. BOX 81  
NORTH EASTHAM, MA 02651  
(508)240-2220  
jason@jcellisdesign.com



JASON C. ELLIS, R.S.

# ADVANTEX® AX20 MODE 3B

## DESIGN NOTES

FOR RESIDENTIAL STRENGTH WASTE UP TO 4-BEDROOMS

INSTALLATION TO BE PERFORMED BY AN ADVANTEX AUTHORIZED INSTALLER ONLY.

START-UP AND SERVICE TO BE PERFORMED BY AN ADVANTEX AUTHORIZED SERVICE PROVIDER ONLY.

Conservation Commislor  
TOWN OF TRURO

OCT 14 2022

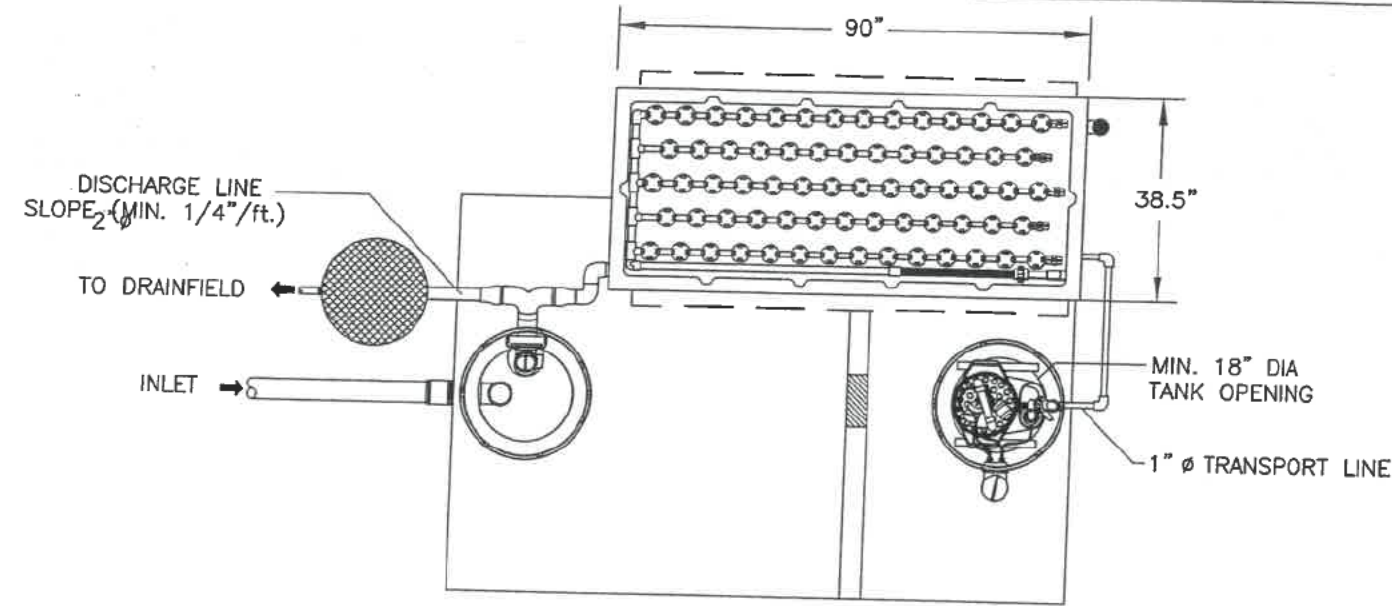

**TOP VIEW**

NOT TO SCALE

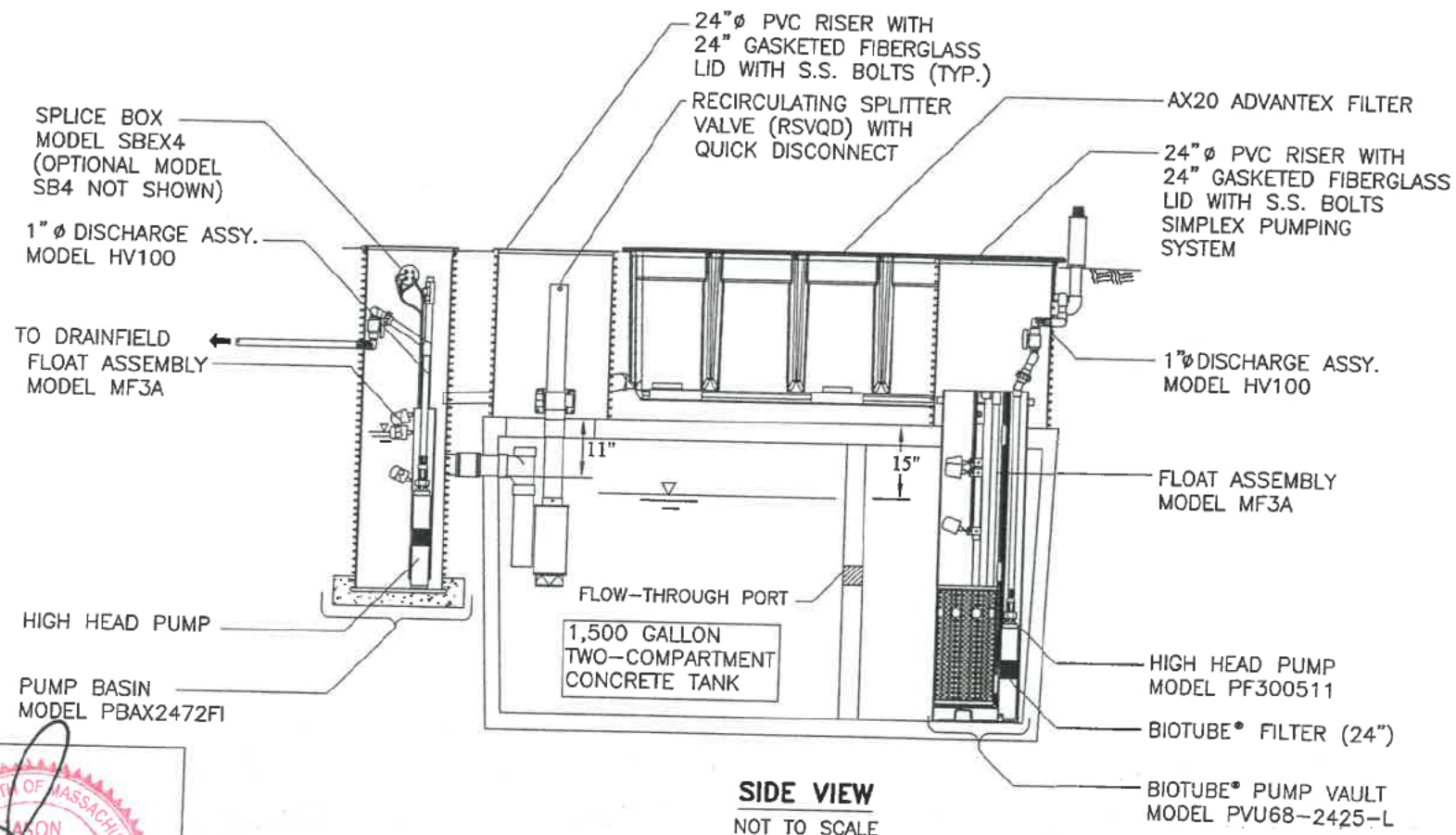

**SIDE VIEW**

NOT TO SCALE

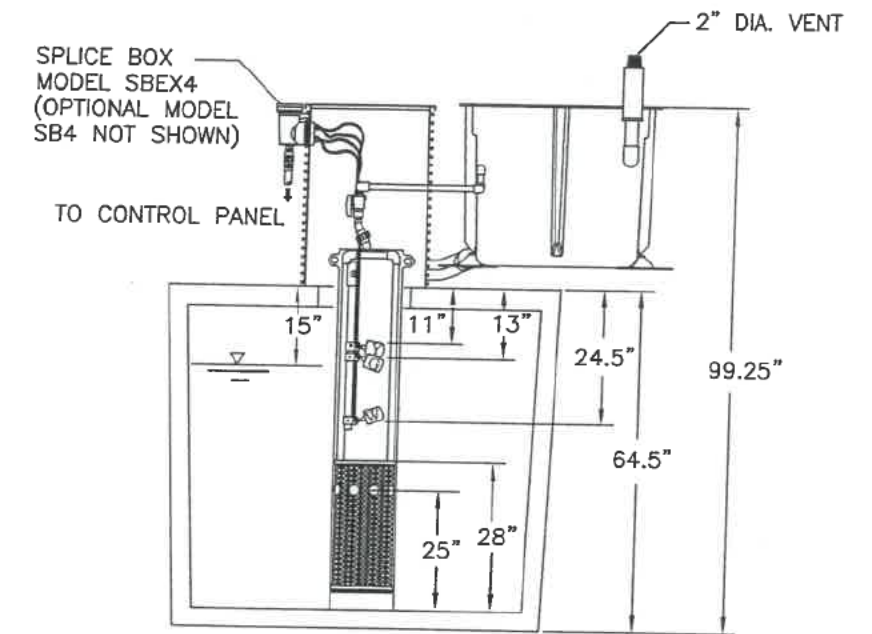

**END VIEW**

NOT TO SCALE

FLOAT FUNCTIONS	
Y	HIGH LEVEL ALARM
G	OVERRIDE TIMER ON/OFF
W	LLA/RO
B	PUMP ON
R	PUMP OFF

J.C. ELLIS DESIGN

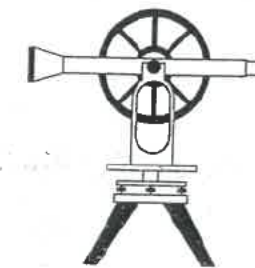

P.O. BOX 81  
NORTH EASTHAM, MA 02651  
(508)240-2220  
jason@jcellisdesign.com

ADVANTEX AX20 1 POD MODE 3B

SUBJECT:

5 JOSEPH'S ROAD  
TRURO, MA

PREPARED FOR:

ROBERT GALLIGAN & ABIGAIL SWAN  
P.O. BOX 175  
TRURO, MA 02666-0175

ASSESSOR'S  
MAP 46 PARCEL 25

DATE: SEPTEMBER 25, 2022

SHEET 3 OF 3



COPYRIGHT © 2013  
ORENCO SYSTEMS®, INC. NDW-ATX-BNDR-6

JASON C. ELLIS, R.S.





# J.C. ELLIS DESIGN COMPANY, INC.

SEPTIC SYSTEM DESIGN & ENGINEERING – SEPTIC INSPECTION –  
SITE PLANNING – WETLAND CONSULTATION & PERMITTING  
P.O. BOX 81, NORTH EASTHAM, MA 02651 PHONE 508-240-2220 FAX 508-240-2221  
EMAIL [jason@jccellisdesign.com](mailto:jason@jccellisdesign.com)

October 14, 2022

Truro Conservation Commission  
Town of Truro  
24 Town Hall Road  
Truro, MA 02666

**Re: Paul & Nancy Fenichel  
2 Marian Lane, Truro, MA  
Assessor's Map 50, Parcel 47**

Dear Commissioners,

This letter accompanies a Notice of Intent and associated plans for a proposed addition to an existing dwelling. The work lies within a wetland resource area as defined in the Truro Conservation Regulations (100' buffer zone). In accordance with section II, chapter 1.05, e, 1 & 2 of the Truro Conservation Regulation, the applicant seeks a variance from section II, chapter 2.02. a 3 of the Truro Conservation Regulation to allow work within a defined wetland resource area.

Thank you for your attention to this request.

Respectfully,

A handwritten signature in black ink, appearing to read 'Jason C. Ellis', written over a large, stylized scribble.

Jason C. Ellis, R.S., L.S.I.T.  
J.C. Ellis Design Co., Inc.







PERMIT # 2022-38



# TOWN OF TRURO

## Conservation Commission

24 Town Hall Road  
P.O. Box 2030, Truro MA 02666

### APPLICATION FOR ADMINISTRATIVE REVIEW PERMIT

**PERMIT FEE \$20**

Applicant Name: Liz Heath Telephone: [REDACTED]

Email address: [REDACTED]

Owner Name: Same Telephone: ↑

(If the applicant is not the owner of the property, written consent to the work MUST be attached to this Application.)

Address of subject property: 5 Marshall Lane Map: 50 Parcel: 161

Description of proposed work: clear brush & mussels  
remove trees close to deck

Proximity to Resource Areas: \_\_\_\_\_

### CRITERIA FOR ADMINISTRATIVE REVIEW (AR) PERMITS

#### Vegetation Projects:

- No removal of vegetation within any inland or coastal wetland resource.
- No uprooting of vegetation.
- No mowing to the ground or clear cutting.
- Any proposed tree removal is demonstrated to be necessary, e.g., to protect existing structures, public safety, traffic visibility, etc.
- Mitigation may be required, i.e., an area to be planted with native species of trees or shrubs.
- Trees for removal must be tagged for inspection.
- No excavation by machinery is required or proposed.

Conservation Commission  
TOWN OF TRURO

OCT 12 2022

#### Sheds and Other Construction Projects:

- No construction *within* any wetland resource except for minimal projects with the consent of the Conservation Agent.
- Any proposed new construction is more than 50' from the edge of resource area.
- No excavation by machinery is required or proposed.
- Foundation for structure shall be concrete blocks, sono tubes, diamond piers
- Repairs or replacement of existing structures remain within the same footprint.
- New structures must be less than 160 square feet.
- Only minimal projects such as biomimicry, sand nourishment, beach grass and planting of native species shall be allowed under this permit

#### Procedure:

- The fee shall be submitted with the Administrative Review Application.
- The Agent shall conduct a site visit, at which time the proposed project must be clearly defined in the field with stakes. Trees shall be flagged.

- If the Agent determines that all of the conditions of this Policy are met, the Agent may approve the Application. If the conditions of this policy are not met; the application is incomplete; or the field ID is inadequate the application is denied.
- If the Agent approves the application, such approval must be ratified by the Truro Conservation Commission prior to the issuance of this permit and prior to the commencement of any work.
- Any Property Owner, contractor or other agent of the owner performing any work pursuant to an Administrative Review permit shall have a copy of the permit available at the site at all times during the period that the work is being performed.
- Upon approval and ratification by the Commission, an Administrative Permit shall issue.
- The applicant shall notify the Commission prior to the start of the work, and must complete the work within thirty (30) days of issuance of the permit, unless otherwise permitted by the Commission.
- The Conservation Agent shall inspect the property to verify that the work completed is within the scope of the Approved Application.
- Any work beyond the scope of the approved Administrative Review shall be subject to enforcement action.
- NOTE: Use of town property for beach access or staging of construction materials requires a permit issued by the Board of Selectmen.

By signing this permit application, you are acknowledging that you have read and understand the terms as stated herein. You are also aware that no work shall go forward until the permit has been issued by the Conservation Commission.

Charles      5/5/22  
 (Signature of Applicant)      (Date)

**FOR OFFICE USE ONLY:**

Agent's Comments site was viewed by Emily Beebe + A. Davis in the summer of 2022

Site Inspection Date: \_\_\_\_\_ Application Approved:  Yes  No

Conservation Commission Review: Meeting Date: \_\_\_\_\_ Permit Approved:  Yes  No  
 Conditions: \_\_\_\_\_

Signature of Commission Chair or Agent: \_\_\_\_\_ Date: \_\_\_\_\_

PERMIT # 2022-39



# TOWN OF TRURO PAID

24 Town Hall Road  
P.O. Box 2030, Truro MA 02666

## APPLICATION FOR ADMINISTRATIVE REVIEW PERMIT

**PERMIT FEE \$20**

Applicant Name: Capizzi Home Improvement Inc Telephone: 508-648-0269  
 Email address: permit@capizzihome.com  
 Owner Name: Bokor Trust Peter Bokor Telephone: 917-584-7726  
 (If the applicant is not the owner of the property, written consent to the work MUST be attached to this Application.)  
 Address of subject property: 1 DUNE WAY Map: 58 Parcel: 28  
 Description of proposed work: FURNISH AND INSTALL NEW RAILINGS ON EXISTING DECK REMOVE & REPLACE DECKING MATERIAL. NO NEW FRAMING OR SONO TUBES NO SOIL DISTURBANCE  
 Proximity to Resource Areas: APPROX 50' TO 65' FROM BACK AREA OF DECK

### CRITERIA FOR ADMINISTRATIVE REVIEW (AR) PERMITS

#### Vegetation Projects:

- No removal of vegetation within any inland or coastal wetland resource.
- No uprooting of vegetation.
- No mowing to the ground or clear cutting.
- Any proposed tree removal is demonstrated to be necessary, e.g., to protect existing structures, public safety, traffic visibility, etc.
- Mitigation may be required, i.e., an area to be planted with native species of trees or shrubs.
- Trees for removal must be tagged for inspection.
- No excavation by machinery is required or proposed.

#### Sheds and Other Construction Projects:

- No construction within any wetland resource except for minimal projects with the consent of the Conservation Agent.
- Any proposed new construction is more than 50' from the edge of resource area.
- No excavation by machinery is required or proposed.
- Foundation for structure shall be concrete blocks, sono tubes, diamond piers
- Repairs or replacement of existing structures remain within the same footprint.
- New structures must be less than 160 square feet.
- Only minimal projects such as biomimicry, sand nourishment, beach grass and planting of native species shall be allowed under this permit

#### Procedure:

- The fee shall be submitted with the Administrative Review Application.
- The Agent shall conduct a site visit, at which time the proposed project must be clearly defined in the field with stakes. Trees shall be flagged.

Conservation Commission  
TOWN OF TRURO

OCT 27 2022





If the Agent determines that all of the conditions of this Policy are met, the Agent may approve the Application. If the conditions of this policy are not met; the application is incomplete; or the field ID is inadequate the application is denied.

- If the Agent approves the application, such approval must be ratified by the Truro Conservation Commission prior to the issuance of this permit and prior to the commencement of any work.
- Any Property Owner, contractor or other agent of the owner performing any work pursuant to an Administrative Review permit shall have a copy of the permit available at the site at all times during the period that the work is being performed.
- Upon approval and ratification by the Commission, an Administrative Permit shall issue.
- The applicant shall notify the Commission prior to the start of the work, and must complete the work within thirty (30) days of issuance of the permit, unless otherwise permitted by the Commission.
- The Conservation Agent shall inspect the property to verify that the work completed is within the scope of the Approved Application.
- Any work beyond the scope of the approved Administrative Review shall be subject to enforcement action.
- NOTE: Use of town property for beach access or staging of construction materials requires a permit issued by the Board of Selectmen.

By signing this permit application, you are acknowledging that you have read and understand the terms as stated herein. You are also aware that no work shall go forward until the permit has been issued by the Conservation Commission.

Jim K. Pugh      10/25/22  
 (Signature of Applicant)      (Date)

**FOR OFFICE USE ONLY**

Agent's Comments

deck boards trailings - no ground disturbance

Site Inspection Date: 10/26/22 Application Approved:  Yes  No

Conservation Commission Review: Meeting Date: \_\_\_\_\_ Permit Approved:  Yes  No  
 Conditions: \_\_\_\_\_

Signature of Commission Chair or Agent: \_\_\_\_\_ Date: \_\_\_\_\_





- Parcel
- Buildings
- Sidewalks
- Street Pavement
- Town Boundary
- MA Highways
- Interstate
- US Highway
- Unimproved Road
- Street Centerlines
- Abutting Towns Label
- Abutting Towns
- Waterbodies
- Major Streams
- Town Mask
- Bath Donutz
- 0-5 ft
- 5-10 ft
- 10-15 ft
- 15-20 ft
- 20-25 ft
- 25-30 ft
- 30-40 ft
- 40-50 ft
- 50-60 ft
- 60-70 ft
- 70+ ft
- Bathymetry
- 0-5 ft
- 5-10 ft
- 10-15 ft
- 15-20 ft
- 20-25 ft
- 25-30 ft
- 30-40 ft
- 40-50 ft
- 50-60 ft
- 60-70 ft
- 70+ ft
- Background

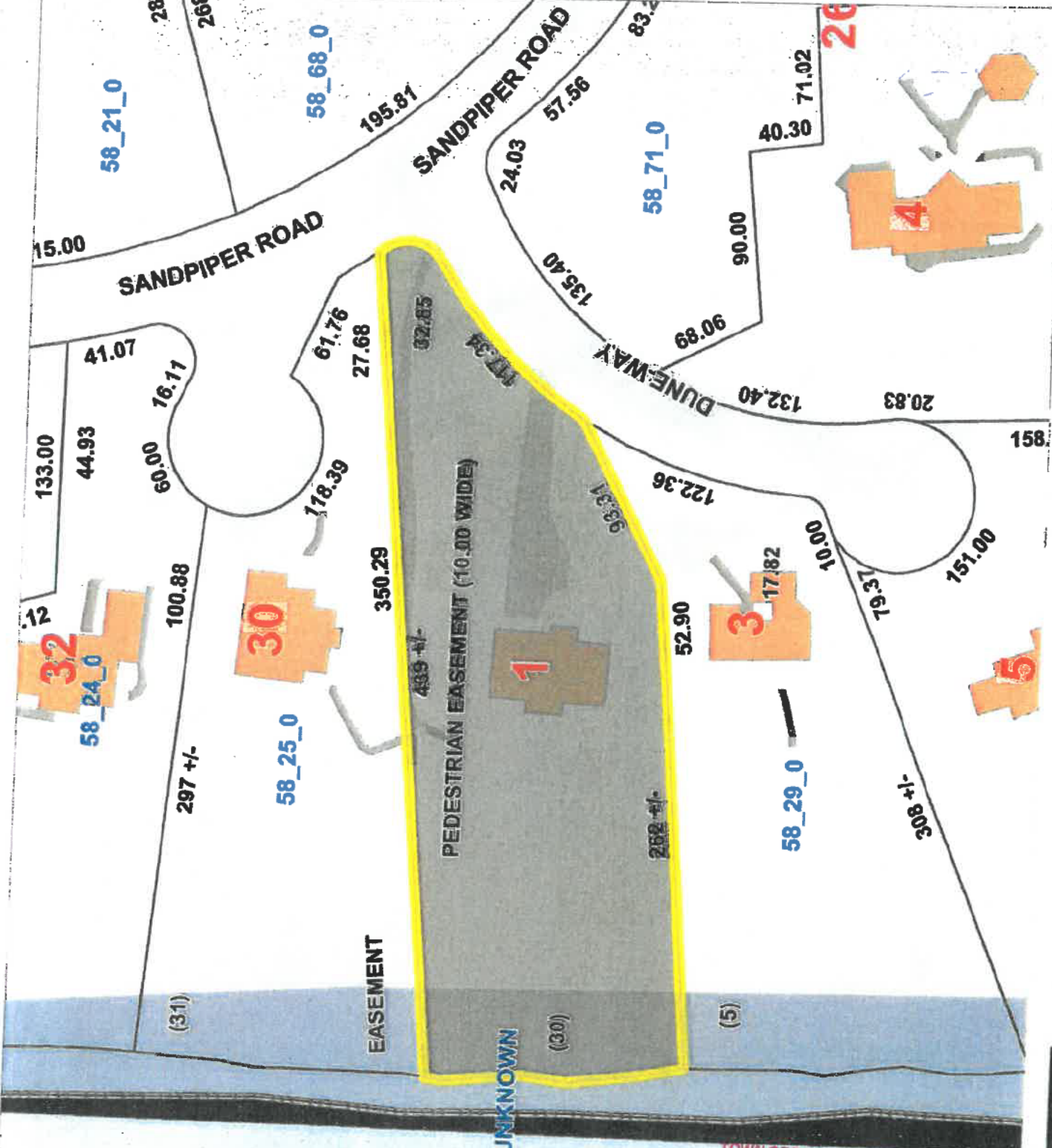

TOWN OF TRURO  
OCT 27 2022

The data shown on this site are provided for informational and planning purposes only. The Town and its consultants are not responsible for the misuse or misinterpretation of the data.



Printed on 10/25/2022 at 04:25 PM



- Permits
- DEP Wetlands
- Barrier Beach-B
- Barrier Beach-C
- Barrier Beach-S
- Barrier Beach-1
- Coastal Bank BI
- Coastal Beach
- Coastal Dune
- Coastal Bog
- Deep Marsh
- Rocky Intertidal
- Salt Marsh
- Shallow Marsh I
- Shrub Swamp
- Tidal Flat
- Wetland Swamp
- Wetland Swamp
- Wetland Swamp
- Wetland Swamp
- Buildings
- Sidewalks
- Street Pavement
- Town Boundary
- MA Highways
- Interstate
- US Highway
- US Road
- Street Centerlines
- Abutting Towns Label
- Abutting Towns
- Waterbodies
- Minor Streams
- Town Mask
- Bath Data/2
- 0-5 ft
- 5-10 ft
- 10-15 ft
- 15-20 ft
- 20-30 ft
- 30-40 ft
- 40-50 ft
- 50-60 ft
- 60-70 ft
- 70+ ft
- Bathymetry
- 5-10 ft
- 10-15 ft
- 15-20 ft
- 20-30 ft
- 30-40 ft
- 40-50 ft
- 50-60 ft
- 60-70 ft
- 70+ ft
- Background

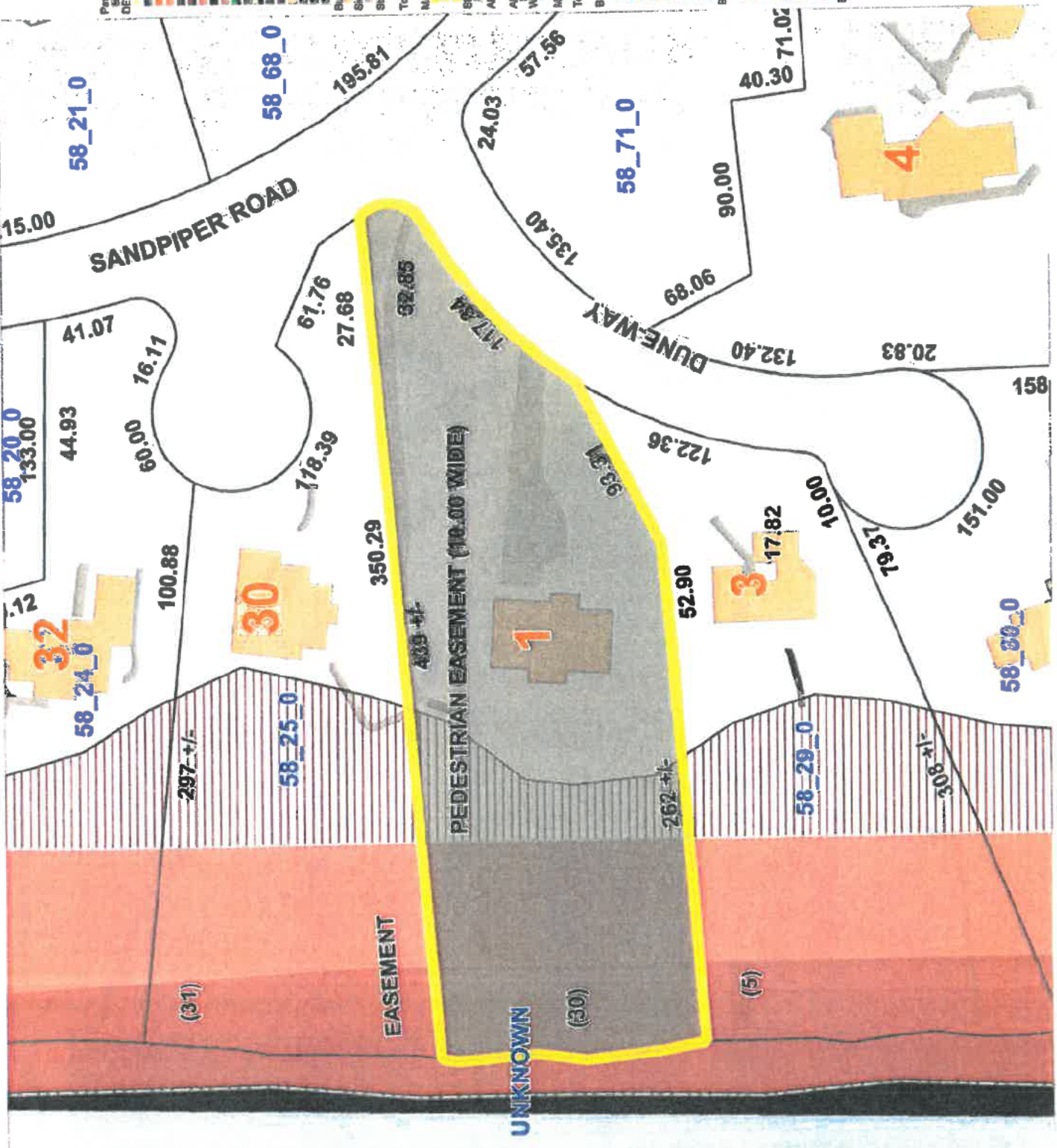

The data shown on this site is for informational purposes only. The user and its consultants are not responsible for the release or misrepresentation of the data.



Printed on 10/25/2022 at 04:30 PM



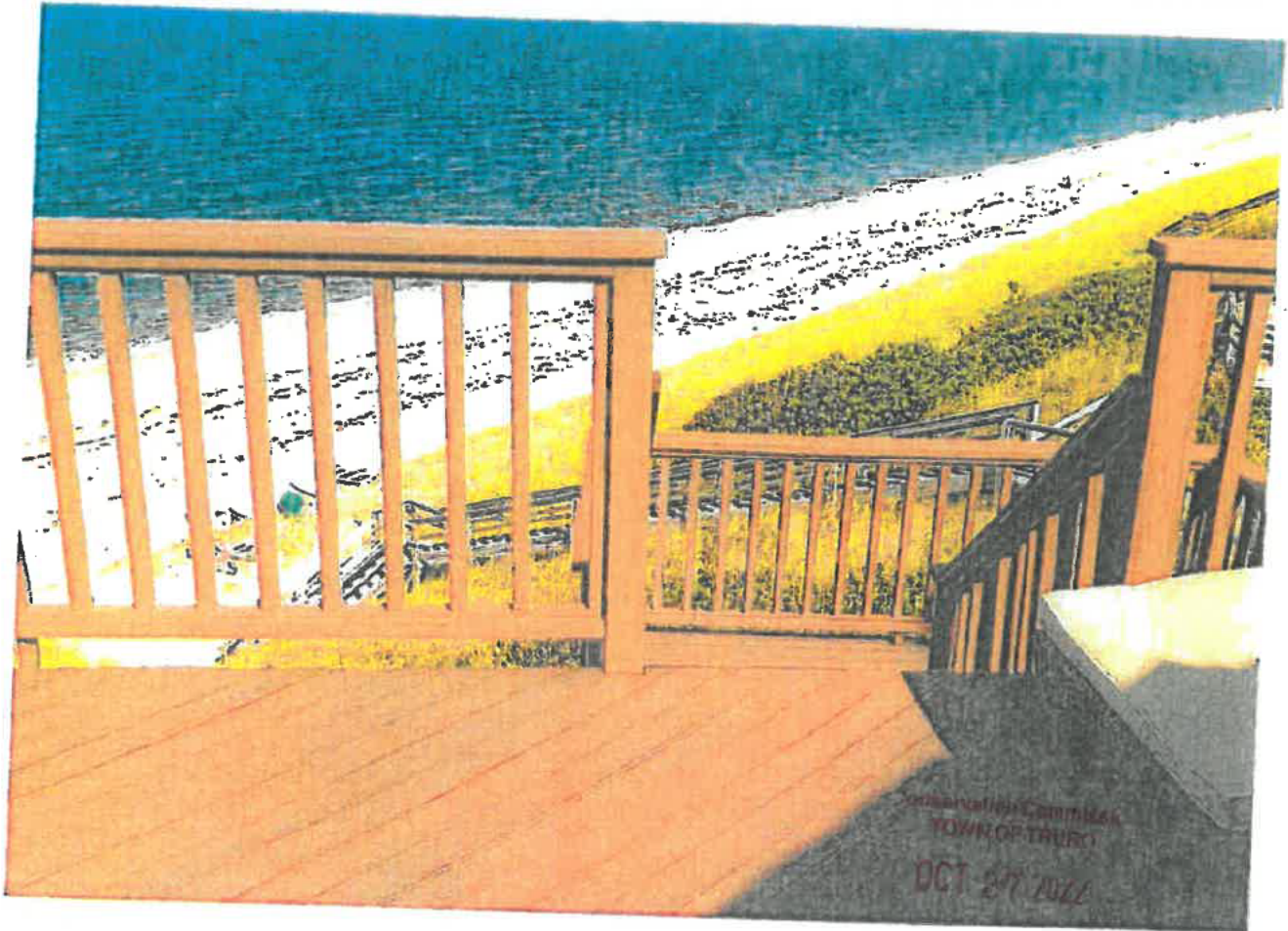
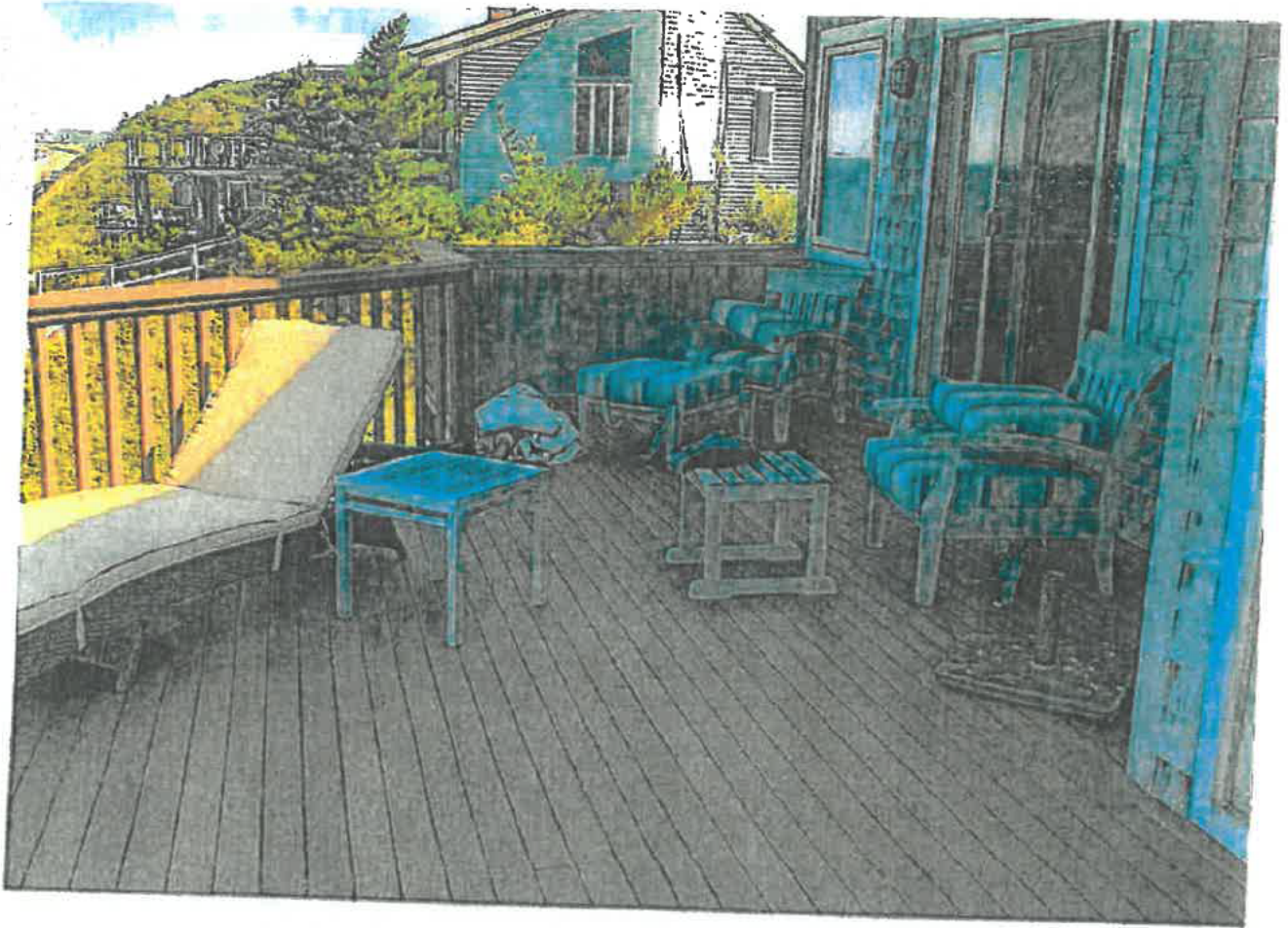



SEP 28 2022



PERMIT # 2022-37



# TOWN OF TRURO

## Conservation Commission

24 Town Hall Road  
P.O. Box 2030, Truro MA 02666

### APPLICATION FOR ADMINISTRATIVE REVIEW PERMIT

**PERMIT FEE \$20**

Applicant Name: Gail Noqueira Telephone: [REDACTED]  
 Email address: [REDACTED]  
 Owner Name: Carl Noqueira Telephone: [REDACTED]  
 (If the applicant is not the owner of the property, written consent to the work MUST be attached to this Application.)  
 Address of subject property: Pilgrims Path Map: 35 Parcel: 112  
 Description of proposed work: repair beach stairs  
stringers and treads  
 Proximity to Resource Areas: \_\_\_\_\_

### CRITERIA FOR ADMINISTRATIVE REVIEW (AR) PERMITS

#### Vegetation Projects:

- No removal of vegetation within any inland or coastal wetland resource.
- No uprooting of vegetation.
- No mowing to the ground or clear cutting.
- Any proposed tree removal is demonstrated to be necessary, e.g., to protect existing structures, public safety, traffic visibility, etc.
- Mitigation may be required, i.e., an area to be planted with native species of trees or shrubs.
- Trees for removal must be tagged for inspection.
- No excavation by machinery is required or proposed.

#### Sheds and Other Construction Projects:

- No construction *within* any wetland resource except for minimal projects with the consent of the Conservation Agent.
- Any proposed new construction is more than 50' from the edge of resource area.
- No excavation by machinery is required or proposed.
- Foundation for structure shall be concrete blocks, sono tubes, diamond piers
- Repairs or replacement of existing structures remain within the same footprint.
- New structures must be less than 160 square feet.
- Only minimal projects such as biomimicry, sand nourishment, beach grass and planting of native species shall be allowed under this permit

#### Procedure:

- The fee shall be submitted with the Administrative Review Application.
- The Agent shall conduct a site visit, at which time the proposed project must be clearly defined in the field with stakes. Trees shall be flagged.



# TOWN OF TRURO

## Conservation Commission

24 Town Hall Road  
P.O. Box 2030, Truro MA 02666

Conservation Commission  
TOWN OF TRURO

SEP 20 2022

PAID 2024

### APPLICATION FOR ADMINISTRATIVE REVIEW PERMIT

PERMIT FEE \$20

Applicant Name: GAIL NOGUEIRA Telephone: [REDACTED]

Email address: [REDACTED]

Owner Name: GAIL NOGUEIRA Telephone: SAME

(If the applicant is not the owner of the property, written consent to the work MUST be attached to this Application.)

Address of subject property: 10 PILGRIMS PATH Map: 35-112-0 Parcel:     

Description of proposed work: REMOVE 3 TREES AND TRIM ANOTHER

Proximity to Resource Areas:     

#### CRITERIA FOR ADMINISTRATIVE REVIEW

##### Vegetation Projects:

- No removal of vegetation within any resource area.
- No uprooting of vegetation.
- No mowing to the ground or clear cutting.
- Any proposed tree removal is demonstrated to be necessary for existing structures, public safety, traffic, or other reasons.
- Mitigation may be required, i.e., an arborist report or shrubs.
- Trees for removal must be tagged for removal.
- No excavation by machinery is required or proposed.

60-day extension request for both dead tree removal + stair repair (double-sided request)

##### Sheds and Other Construction Projects:

- No construction within any wetland resource area without the consent of the Conservation Agent.
- Any proposed new construction is more than 50' from the edge of resource area.
- No excavation by machinery is required or proposed.
- Foundation for structure shall be concrete blocks, sono tubes, diamond piers.
- Repairs or replacement of existing structures remain within the same footprint.
- New structures must be less than 160 square feet.
- Only minimal projects such as biomimicry, sand nourishment, beach grass and planting of native species shall be allowed under this permit.

##### Procedure:

- The fee shall be submitted with the Administrative Review Application.
- The Agent shall conduct a site visit, at which time the proposed project must be clearly defined in the field with stakes. Trees shall be flagged.

PERMIT # 2022-40



# TOWN OF TRURO

## Conservation Commission

24 Town Hall Road  
P.O. Box 2030, Truro MA 02666

# PAID

Conservation Commission  
TOWN OF TRURO

OCT 28 2022

### APPLICATION FOR ADMINISTRATIVE REVIEW PERMIT

PERMIT FEE \$20

Sladeville Condos

Applicant Name: Charles W. Wemeyer (Trustee) Telephone: [Redacted]

Email address: [Redacted]

Owner Name: Sladeville Condo Assn. Telephone: [Redacted]

(If the applicant is not the owner of the property, written consent to the work MUST be attached to this Application.)

Address of subject property: 2 Meetinghouse Rd Map: 50 Parcel: 4

Description of proposed work: Removal of standing dead tree, Removal of tree branch that is hazardous and clogs 14' x 14' clearance on driveway

Proximity to Resource Areas: less than 50' of vegetation for the five dept.

### CRITERIA FOR ADMINISTRATIVE REVIEW (AR) PERMITS

#### Vegetation Projects:

- No removal of vegetation within any inland or coastal wetland resource.
- No uprooting of vegetation.
- No mowing to the ground or clear cutting.
- Any proposed tree removal is demonstrated to be necessary, e.g., to protect existing structures, public safety, traffic visibility, etc.
- Mitigation may be required, i.e., an area to be planted with native species of trees or shrubs.
- Trees for removal must be tagged for inspection.
- No excavation by machinery is required or proposed.

#### Sheds and Other Construction Projects:

- No construction *within* any wetland resource except for minimal projects with the consent of the Conservation Agent.
- Any proposed new construction is more than 50' from the edge of resource area.
- No excavation by machinery is required or proposed.
- Foundation for structure shall be concrete blocks, sono tubes, diamond piers
- Repairs or replacement of existing structures remain within the same footprint.
- New structures must be less than 160 square feet.
- Only minimal projects such as biomimicry, sand nourishment, beach grass and planting of native species shall be allowed under this permit

#### Procedure:

- The fee shall be submitted with the Administrative Review Application.
- The Agent shall conduct a site visit, at which time the proposed project must be clearly defined in the field with stakes. Trees shall be flagged.



PAID

If the Agent determines that all of the conditions of this Policy are met, the Agent may approve the Application. If the conditions of this policy are not met; the application is incomplete; or the field ID is inadequate the application is denied.

- **If the Agent approves the application, such approval must be ratified by the Truro Conservation Commission prior to the issuance of this permit and prior to the commencement of any work.**
- Any Property Owner, contractor or other agent of the owner performing any work pursuant to an Administrative Review permit shall have a copy of the permit available at the site at all times during the period that the work is being performed.
- Upon approval and ratification by the Commission, an Administrative Permit shall issue.
- The applicant shall notify the Commission prior to the start of the work, and must complete the work within thirty (30) days of issuance of the permit, unless otherwise permitted by the Commission.
- The Conservation Agent shall inspect the property to verify that the work completed is within the scope of the Approved Application.
- Any work beyond the scope of the approved Administrative Review shall be subject to enforcement action.
- NOTE: Use of town property for beach access or staging of construction materials requires a permit issued by the Board of Selectmen.

By signing this permit application, you are acknowledging that you have read and understand the terms as stated herein. You are also aware that no work shall go forward until the permit has been issued by the Conservation Commission.

[Signature] (Signature of Applicant)      10/19/22 (Date)

FOR OFFICE USE ONLY:

Agent's Comments dead tree removal + clearance for ambulance access

Site Inspection Date: 10/31/2022 Application Approved:  Yes  No

Conservation Commission Review: Meeting Date: \_\_\_\_\_ Permit Approved:  Yes  No  
Conditions: \_\_\_\_\_

Signature of Commission Chair or Agent: \_\_\_\_\_ Date: \_\_\_\_\_

**From:** Nancy Lustgarten nancylustgarten@gmail.com ✉  
**Subject:** Tree branch  
**Date:** October 18, 2022 at 4:17 PM  
**To:** Charles Wiemeyer cwdcinc@mac.com

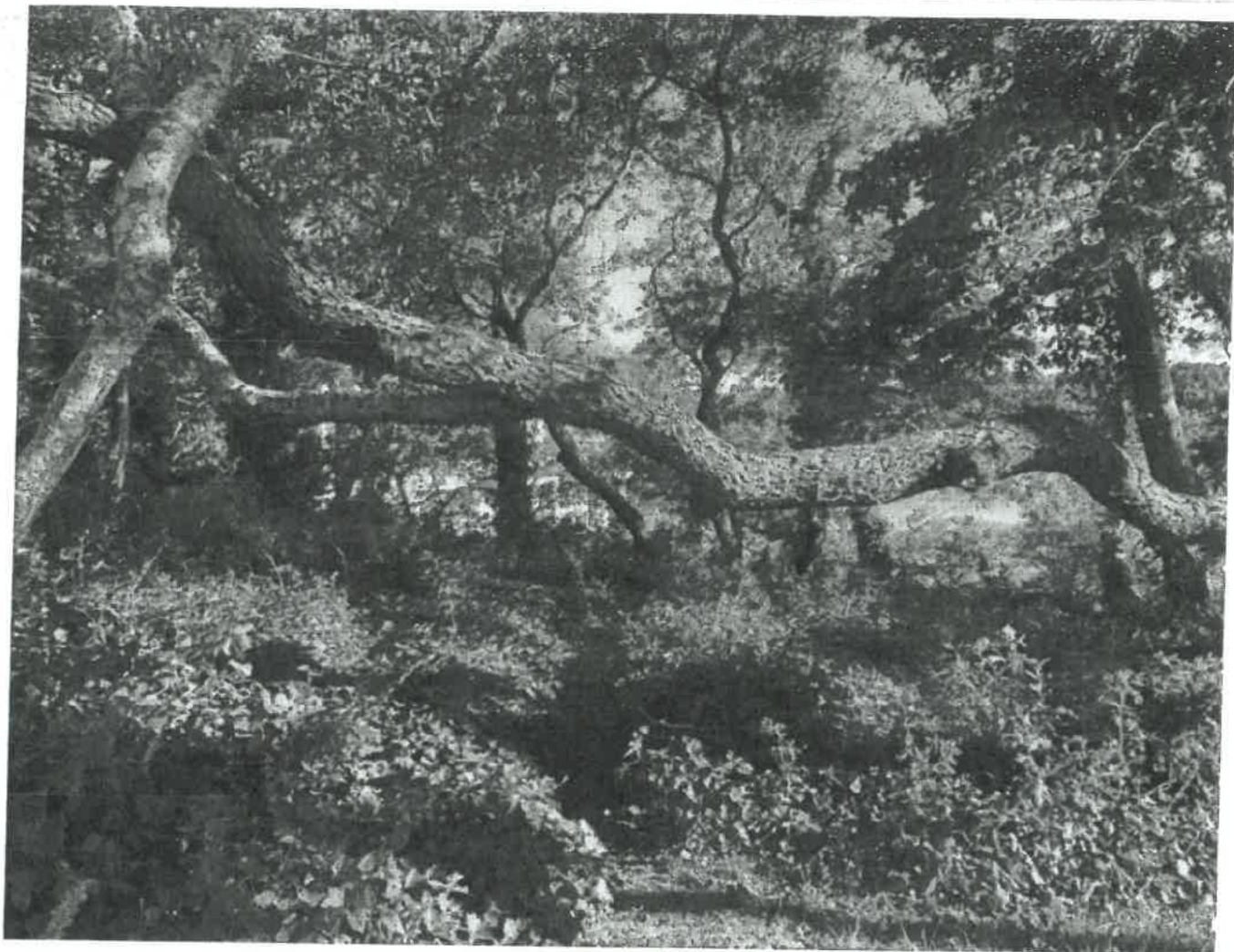

↙ Failing tree branch



Horizontal  
Tree branch  
that has failed

Standing dead  
tree

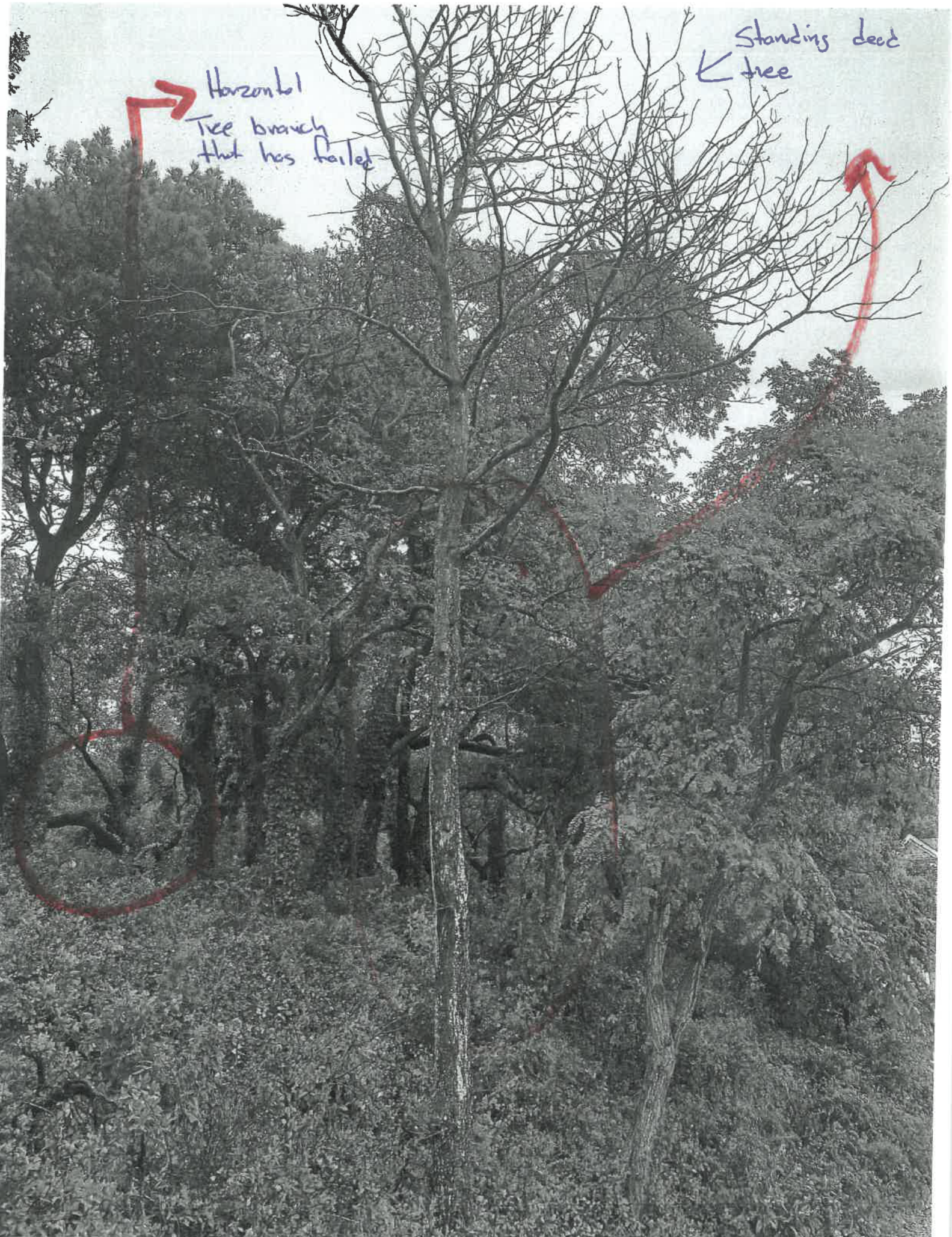



Creeke

14' x 14'

Clearance of  
overhang in back  
on Main Driveway

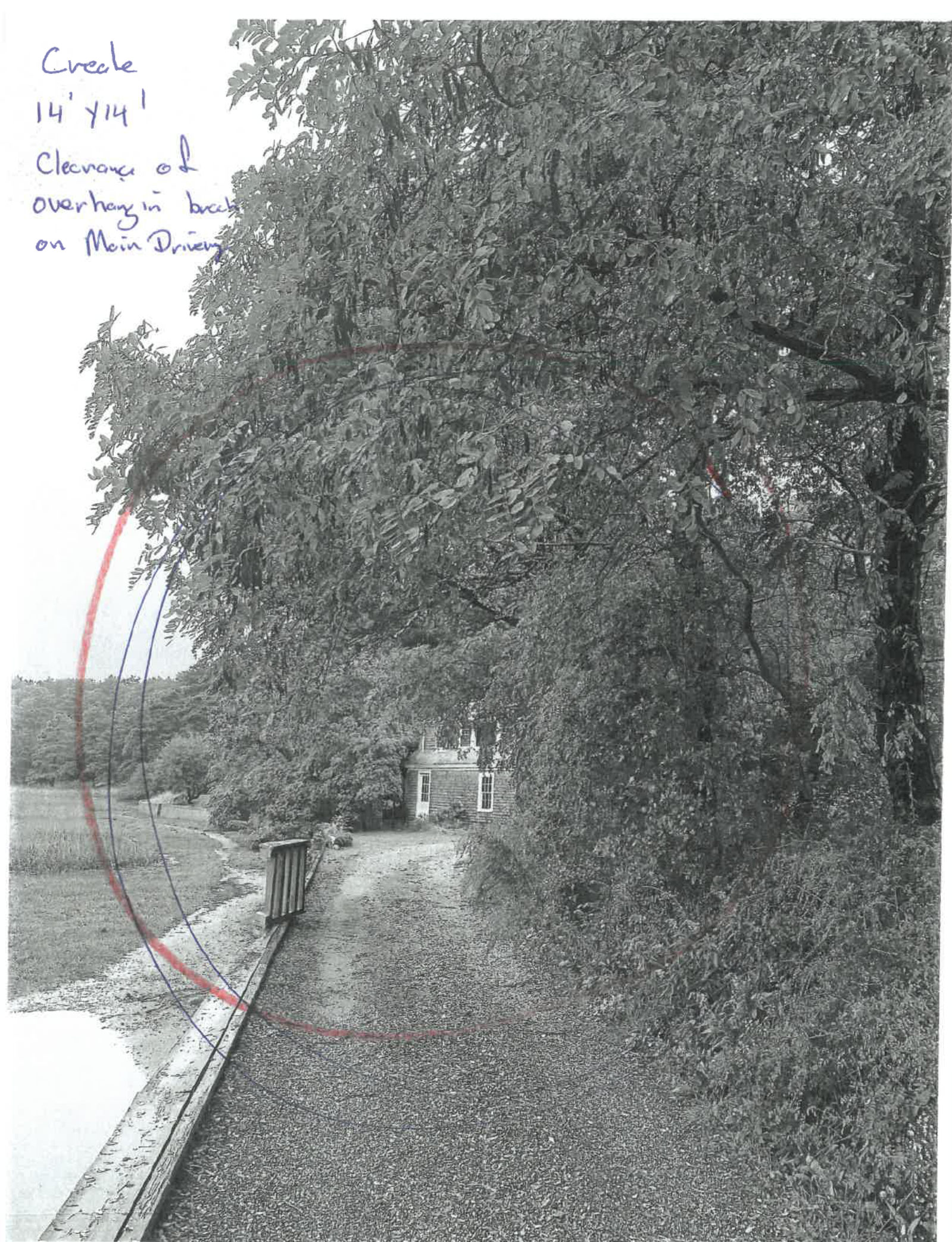



PERMIT # 2022-32



# TOWN OF TRURO

## Conservation Commission

24 Town Hall Road  
P.O. Box 2030, Truro MA 02666

Conservation Commission  
TOWN OF TRURO

AUG 23 2022  
PAID 506

### APPLICATION FOR ADMINISTRATIVE REVIEW PERMIT

**PERMIT FEE \$20**

Applicant Name: Jane Petterson Telephone: [REDACTED]

Email address: [REDACTED]

Owner Name: Joseph Bagdos Telephone: [REDACTED]

(If the applicant is not the owner of the property, written consent to the work MUST be attached to this Application.)

Address of subject property: 26 Pond Rd, No. Truro Map: 36 Parcel: 36-188-0

Description of proposed work: Replace existing<sup>a</sup> stairs and landing

Proximity to Resource Areas: Buffer zone to Pond

### CRITERIA FOR ADMINISTRATIVE REVIEW (AR) PERMITS

#### Vegetation Projects:

- No removal of vegetation within any inland or coastal wetland resource.
- No uprooting of vegetation.
- No mowing to the ground or clear cutting.
- Any proposed tree removal is demonstrated to be necessary, e.g., to protect existing structures, public safety, traffic visibility, etc.
- Mitigation may be required, i.e., an area to be planted with native species of trees or shrubs.
- Trees for removal must be tagged for inspection.
- No excavation by machinery is required or proposed.

#### Sheds and Other Construction Projects:

- No construction *within* any wetland resource except for minimal projects with the consent of the Conservation Agent.
- Any proposed new construction is more than 100 sq ft.
- No excavation by machinery is required or proposed.
- Foundation for structure shall be concrete.
- Repairs or replacement of existing structures shall be approved.
- New structures must be less than 160 square feet.
- Only minimal projects such as biomimicry or planting of native species shall be allowed.

#### Procedure:

- The fee shall be submitted with the Administrative Review Permit Application.
- The Agent shall conduct a site visit, at which time the work shall be clearly defined in the field with stakes. The work shall be completed within 30 days of the date of the site visit.

The Applicant needs another 30-day ext as the beam work (another approved AR) took longer than expected + delayed the stair work.

A. Davis  
11/1/2022

\*30-day ext in Oct.



**MEMO: ADMINISTRATIVE REVIEW EXTENSION REQUEST**  
**510 Shore Rd, Unit A**

To: Conservation Commission  
From: Arozana Davis on behalf of Applicant, Kaye McFadden

11/1/2022

Commission Members,

Kaye McFadden would like to request an extension to her AR for 510 Shore Rd, U:A (replacement of deck boards and railings on elevated deck – no structural or support related work). You issued the original approval on 6/6/2022 and then approved an additional extension in August. The project was delayed because of supply availability and so she is requesting an additional 30-days.

She will also be doing the same type of work on Unit B, which she has filed a new AR for.

You are getting the request via a memo because we are unable to locate the original approved paperwork – so I can't make you a copy. Hopefully this will be sufficient.

Respectfully,

Arozana

A handwritten signature in blue ink, consisting of the letters "AD" inside a large, hand-drawn oval.





# TOWN OF TRURO

# PAID

## Conservation Commission

Conservation Commission  
TOWN OF TRURO

24 Town Hall Road  
P.O. Box 2030, Truro MA 02666

NOV 02 2022

### APPLICATION FOR ADMINISTRATIVE REVIEW PERMIT

**PERMIT FEE \$20**

Applicant Name: CAPE TIP CONSTRUCTION Telephone: 508-737-5638

Email address: capetip1967@icloud.com

Owner Name: MARY WELLS Telephone: [REDACTED]

(If the applicant is not the owner of the property, written consent to the work MUST be attached to this Application.)

Address of subject property: 510 SHORE RD UNIT B Map: \_\_\_\_\_ Parcel: \_\_\_\_\_

Description of proposed work: ONE FOR ONE REPLACEMENT OF DECK RAILINGS, DECK BOARDS, AND JOISTS. NO CHANGE TO SUPPORTING PIERS

Proximity to Resource Areas: IN RESOURCE - REMOVE 90 DAYS

### CRITERIA FOR ADMINISTRATIVE REVIEW (AR) PERMITS

#### Vegetation Projects:

- No removal of vegetation within any inland or coastal wetland resource.
- No uprooting of vegetation.
- No mowing to the ground or clear cutting.
- Any proposed tree removal is demonstrated to be necessary, e.g., to protect existing structures, public safety, traffic visibility, etc.
- Mitigation may be required, i.e., an area to be planted with native species of trees or shrubs.
- Trees for removal must be tagged for inspection.
- No excavation by machinery is required or proposed.

#### Sheds and Other Construction Projects:

- No construction within any wetland resource except for minimal projects with the consent of the Conservation Agent.
- Any proposed new construction is more than 50' from the edge of resource area.
- No excavation by machinery is required or proposed.
- Foundation for structure shall be concrete blocks, sono tubes, diamond piers
- Repairs or replacement of existing structures remain within the same footprint.
- New structures must be less than 160 square feet.
- Only minimal projects such as biomimicry, sand nourishment, beach grass and planting of native species shall be allowed under this permit

#### Procedure:

- The fee shall be submitted with the Administrative Review Application.
- The Agent shall conduct a site visit, at which time the proposed project must be clearly defined in the field with stakes. Trees shall be flagged.

- If the Agent determines that all of the conditions of this Policy are met, the Agent may approve the Application. If the conditions of this policy are not met; the application is incomplete; or the field ID is inadequate the application is denied.
- **If the Agent approves the application, such approval must be ratified by the Truro Conservation Commission prior to the issuance of this permit and prior to the commencement of any work.**
- Any Property Owner, contractor or other agent of the owner performing any work pursuant to an Administrative Review permit shall have a copy of the permit available at the site at all times during the period that the work is being performed.
- Upon approval and ratification by the Commission, an Administrative Permit shall issue.
- The applicant shall notify the Commission prior to the start of the work, and must complete the work within thirty (30) days of issuance of the permit, unless otherwise permitted by the Commission.
- The Conservation Agent shall inspect the property to verify that the work completed is within the scope of the Approved Application.
- Any work beyond the scope of the approved Administrative Review shall be subject to enforcement action.
- NOTE: Use of town property for beach access or staging of construction materials requires a permit issued by the Board of Selectmen.

By signing this permit application, you are acknowledging that you have read and understand the terms as stated herein. You are also aware that no work shall go forward until the permit has been issued by the Conservation Commission.

Wynne McEadden      11/2/2022  
 (Signature of Applicant)      (Date)

**FOR OFFICE USE ONLY:**

Agent's Comments: same as unit A - replacing deck boards trailing on elevated deck.

Site Inspection Date: 11/2/22 Application Approved:  Yes  No

Conservation Commission Review: Meeting Date: \_\_\_\_\_ Permit Approved:  Yes  No  
 Conditions: \_\_\_\_\_

Signature of Commission Chair or Agent: \_\_\_\_\_ Date: \_\_\_\_\_

HEALTH DEPARTMENT  
TOWN OF TRURO

NOV 02 2022

RECEIVED BY: \_\_\_\_\_

HEALTH DEPARTMENT  
TOWN OF TRURO

NOV 21 2022

RECEIVED BY: \_\_\_\_\_

EXISTING  
PIERS STAY

PROPOSED SOUTH ELEVATION  
SCALE: 1/4" = 1'-0"

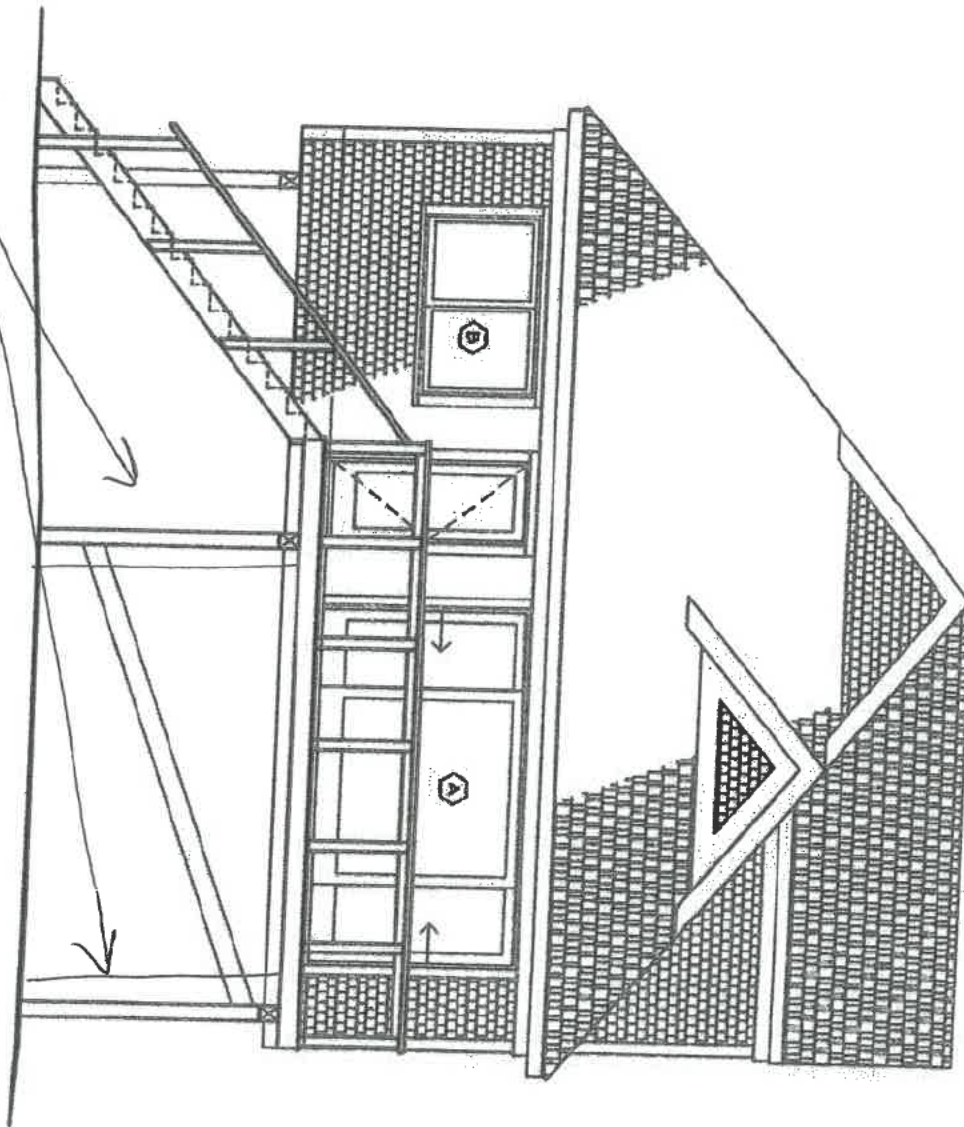

JANUARY 27, 2021

P2

CAPE TIP CONSTRUCTION  
PO BOX 182 - PROVINCETON, MASSACHUSETTS 02861  
PROPOSED CONDITIONS

UNIT A  
510 SHORE ROAD  
TRURO, MASSACHUSETTS





**TOWN OF TRURO  
CONSERVATION COMMISSION**

P.O. Box 2030  
Truro MA 02666-0630

**Conservation Commission Meeting Minutes: July 11, 2022**

**Commissioners Present:** Chair Commissioner Carol Girard-Irwin, Vice Chair Commissioner Linda Noons-Rose, Commissioners Bob White, Mark Adams, Diane Messinger & Larry Lown **Absent:** none **Others Present:** Emily Beebe, Conservation Agent Courtney Warren, Assistant Conservation Agent.

**This was a remote meeting. Chair Carol Girard-Irwin called the meeting and public hearings to order at 5:01 PM and provided virtual instructions.**

**Public Comment:** There was no public comment.

**Notice of Intent: 491 Shore Rd, Jennifer E. Cabral, SE# 75-1150:**

Jennifer Cabral was on the call to represent the project. She is proposing to repair an existing dilapidated garage, raise it up on pilings, and transform it into a workshop. Commissioner Diane Messinger inquired about a bathroom that is shown on the proposed plans and what the surrounding septic and well conditions are on the property. She also had a question about the stairway being outside of the original footprint. The stairway is necessary to access the newly raised building, which will be used for woodworking. Liam Cabral stated that the plan is to install an incinerating toilet and a sink. A discussion about this type of toilet and a water connection ensued and the applicants were asked for more information. The Conservation Agent mentioned that there would be an issue with the sink, as it generates grey water which needs a title 5 septic system for disposal. Commissioner Linda Noons-Rose asked about any plans to deal with the roof run off. Paul Shea was on the call and stated that the sand around the small building is quite coarse and pervious and makes roof run off a non-issue. Commissioner White suggested removal of the paved section of driveway as a benefit and Paul Shea confirmed that the proposed driveway would be pervious. There was more discussion about containment/management of storm water. Paul Shea discussed the proposed plans for the structure and that raising the structure will reduce flood impacts. The area under the new structure will become pervious and it currently is not. Commissioner Diane Messinger asked about staking the lot and what was planned for the area underneath the raised structure. Mr. Shea answered that it would just be open sand and that the property could be staked. The Conservation Agent noted that there was a discrepancy between the proposed and existing site plans and that the location of the access point to the shed must be shown on the plan before the hearing closed, further, that the site plan properly depicts the Bordering Vegetative Wetland, but the narrative does not; lastly, the matter of the details about the gray water/sink. A letter from an abutter (Russell and Nancy Braun) was read for the record and reflected the abutter's support for the proposed project. The applicants asked for a continuance until the August 1<sup>st</sup>, 2022 meeting.

**Motion:** Commissioner Linda Noons-Rose moved to continue until the August 1, 2022, meeting. **Second:** Commissioner Mark Adams; **Vote:** 6-0-0; the motion passed.

**Request for Determination of Applicability: 599 Shore Rd, Natividad Carmona:**

Natividad Carmona was on the call to represent the project. This was an after-the-fact filing for a fence replacement. The work was done as a safety precaution using the existing fence holes and the owner was unaware that he needed a filing. The Commission encouraged Mr. Carmona to contact the Conservation Agent if he had any questions concerning future projects. **Motion: Commissioner Bob White moved to approve a negative 3 determination; Second: Commissioner Linda Noons-Rose; Vote: 6-0-0; the vote was unanimous, and the motion passed.**

**Notice of Intent: 39 Bayview Rd, Lawrence Gottesdiener; SE# 75-1140:**

Daniel Ojala and Ben Zehnder were on the call to represent the project. Daniel Ojala described the proposal to remove the existing home and build a new house that is completely out of the 50 ft buffer zone and as far landward as zoning setbacks allow. Six Thousand square feet of the site will be revegetated with native plants. This revised plan shows the proposed pool rotated 90 degrees from the location on the original plans. Commission Chair Carol Girard Irwin asked whether a work limit had been established. Mr. Ojala explained that the work limit would run along the top of the coastal bank to provide a generous work area, since most of the area would be revegetated once the project was complete. Much of the discussion centered on the pool: its location, depth, weight relative to the sand it would displace, type of pavement around the pool, and its general permissibility in the buffer zone. Commissioner Carol Girard Irwin asked whether the pool could be rotated 90 degrees so that it would be almost completely out of the buffer zone. Mr. Ojala explained that the automatic pool cover that proposed instead of a fence would prevent that move. Attorney Ben Zehnder stated that the regulations seek to minimize impact in resource areas but that the proposed project was in the buffer zone and that a pool could be allowed if the circumstances were right. He stated that the applicant was proposing to remove their house completely from the 50 ft buffer zone and replace it with a smaller structure. The Agent suggested that it was important to consider all the alternatives and examine what is practicable in this area and what offers the most protection to the surrounding resource areas. Attorney Zehnder requested a continuance until the August 1<sup>st</sup>, 2022, meeting. **Motion: Commissioner Linda Noons Rose moved to grant the continuance; Second: Commissioner Bob White; Vote: 5-1-0.**

**Notice of Intent: 3 Corn Hill Path, Gerald & Marlene Talbot, SE# 75-1149:**

Ben Zehnder, Todd Turcotte, and Teresa Sprague were on the call to represent the project. Todd Turcotte presented the proposed plan to construct a stairway as an extension from an existing boardwalk down to the beach. The plan would utilize a crane at the top to supply materials down the coastal bank as well as a crane on the beach. All of the commissioners expressed concerns about the potential for significant impact to the resource area and didn't feel there was enough justification for such a disturbance given that there was a shared (community) beach access stair located a short distance from the property. Mr. Turcotte explained that the access to the neighborhood stairway is about 1,420 feet compared to 250 feet using the proposed stairway. The Conservation Agent explained that although the regulations can allow stairways because there is an alternative, a conclusion could be reached that the impact of constructing the proposed stairway is unnecessary and an adverse impact on the resource area and buffer zone. The

well-vegetated area between the house and top of the bank is a sand-plain heathland, a rare habitat defined as critically imperiled by Natural Heritage. Theresa Sprague detailed the mitigation plans for the project and noted that the area was sand-plain heathland with a very healthy plant community; this which need to be preserved as much as possible and restored where necessary. The area where the crane would be set would need to be restored. The plan for preserving the healthy vegetation would be to remove much of it prior to construction, to save the plants, and then replant after construction, especially since several of the species found in the area of proposed disturbance are not available commercially. (Neither *hudsonia* or reindeer lichen can be found in nurseries) The plan for the top of the bank is to revegetate with little blue stem and beach grass to help keep that area stable. The Agent asked Todd Turcotte how he proposes to get the cranes onto the beach. He explained that the plan is to use the Corn Hill access and that he does understand the process for getting permission from the abutters and the town. Commissioner Messinger expressed concern about the impacts that the cranes would make in a fragile area.

Ben Zehnder asked for continuance to further develop the proposal.

**Motion: Commissioner Girard Irwin made a motion to continue the matter as requested; Second: Commissioner Linda Noons-Rose; Vote: 0-5-1;**

**(Commissioner Larry Lown abstained due to technical issues.)**

**The motion failed.**

Ben Zehnder then requested to withdraw the application without prejudice.

**Motion: Commissioner Bob White moved to accept the withdrawal request without prejudice. Second: Commissioner Linda Noons-Rose; Vote: 6-0-0; the motion passed.**

**Administrative Review Permit requests:**

1.) **21 South Pamet Rd:** rebuild existing stairs and extend existing timber landscape wall, add planter. This 60-day request is for work proposed in the buffer zone to a coastal bank. The Conservation Agent reviewed the Administrative Review requirements, which state that no machines be used to perform the work. If machinery is required, an RDA would be necessary. Dawn Snow was on the call to represent the project. She would like to repair some stone and timber stairs and shift them slightly for safety on the steep grade. Carol Girard-Irwin wanted to clarify if the proposed plan is a one-to-one replacement and not any additional work. Dawn Snow affirmed that the proposal is for a one for one replacement of existing stairs, but she was not sure whether the timber stairs would require machinery. The Agent explained the process for returning for an RDA if need be.

**Motion: Bob White moved to approve the Administrative Review permit with the condition that no machines shall be used to complete the proposed work.**

**Second: Linda Noons-Rose; Vote: 5-0-1 ; the motion passed. (Commissioner Larry Lown abstains due to technical issues)**

2.) **4A Pond Rd:** tree limb removal- ratification.

**Motion: Commissioner Carol Girard-Irwin moved to approve the administrative review permit. Second: Commissioner Diane Messinger; Vote: 5-0-1; the motion passed. (Commissioner Larry Lown abstains due to technical issues)**



**Certificate of Compliance Request:**

**218 Shore Rd, SE# 75-1076**

The Conservation Agent explained that this is a project with ongoing conditions to maintain the seawall.

**Motion: Commissioner Bob White moved to approve the certificate of compliance with ongoing conditions. Second: Commissioner Linda Noons Rose; Vote: 5-0-1; the motion passed. (Commissioner Larry Lown abstains due to technical issues)**

**Minutes:** No minutes were ready for review.

**Commissioner Carol Girard Irwin moved to adjourn the meeting.**

**Second: Commissioner Bob White Vote: 5-0-1; the motion passed.**  
(Commissioner Larry Lown abstains due to technical issues)

**The meeting was adjourned at 7:43 PM.**

Respectfully Submitted by Nina Richey



**TOWN OF TRURO  
CONSERVATION COMMISSION**  
P.O. Box 2030  
Truro MA 02666-0630

**Conservation Commission Meeting Minutes: August 1, 2022**

**Commissioners Present:** Chair Commissioner Carol Girard-Irwin, Commissioners Bob White, Mark Adams, Diane Messinger, Larry Lown, & Clint Kershaw

**Absent:** Vice Chair Commissioner Linda Noons-Rose; Also Present: Emily Beebe, Conservation Agent, Courtney Warren, Assistant Conservation Agent.

**The Chair, Carol Girard-Irwin, called the meeting and public hearings to order at 5:00 PM and provided virtual instructions.**

**Public Comment:** There was no public comment.

**Notice of Intent: 491 Shore Road, Jennifer E. Cabral, SE# 75-1150:***(Continued from 7/11/2022)* Jennifer Cabral was on the call to represent the project, and noted that the original plans had been revised to show the access stairway and landing; the proposed incinerating toilet and sink have been removed from the plan. The impermeable sections of the driveway will be removed, and a system will be installed to deal with roof runoff. Commissioner Lown asked if the public would be coming to the workshop and the answer was no. Commissioner Girard-Irwin asked about any paints or stains that would be used in the shop. Ms. Cabral described their standard process for handling both water-based and oil-based substances. **Motion:** Commissioner Larry Lown moved to approve the filing. **Second:** Commissioner Bob White; **Vote:** 5-0-0; **the motion passed.**

**Notice of Intent: 39 Bayview Road, Lawrence Gottesdiener; SE# 75-1140:***(Continued from 7/11/2022)*

The applicants requested a continuance until the September 12<sup>th</sup>, 2022, meeting.

**Motion:** Commissioner Bob White moved to continue the matter until September 12<sup>th</sup>, 2022 **Second:** Commissioner Mark Adams; **Vote:** 5-0-0; **The motion passed.**

**Request for Determination of Applicability: 13 Depot Road, Christine & Ernie Sanders:** Christine and Ernie Sanders were on the call to represent the project. The proposed 16x8 garden shed will be on blocks, and they are proposing to plant bearberry in any disturbed areas after construction is complete. Commissioner Lown asked about the square footage of the proposed shed and whether there would be any windows, doors, plumbing, or electricity in the structure. The shed is proposed to be 128 square feet with a door and a window for ventilation but no electricity or plumbing. Commissioner White asked about mitigation for roof runoff. Ms. Sanders stated there would be permeable gravel around the shed to naturally deal with runoff. Commissioner Adams suggested mimicking the natural heathland on the Coastal Bank incorporating ferns, bayberry, and native grasses as well as bearberry in the planting plan. **Motion:** Commissioner Bob



**White moved a negative 3 determination; Second: Commissioner Diane Messinger; Vote: 6-0-0; The motion passed.**

**Notice of Intent: 3 Knowles Heights Road, Bonnie Brown-Bonse; SE# 75-1151:**

Matthew Farrell was on the call to represent the project which is a septic upgrade to an innovative/alternative system. Part of this property is in the 50' and 100' buffers to a coastal bank while the rest of the property is outside conservation jurisdiction. He described the system and in particular the septic tanks and pump chambers necessary to service cottages 1-5 which are located at the lowest elevation of the property and are in the 50-foot buffer zone. Commissioner Messinger asked about the restoration of the disturbed areas and was told the plan is to revegetate disturbed areas with American Beachgrass. Commissioner Girard-Irwin inquired about the number of cesspools that would be removed. Mr. Farrell stated that there were five cesspools in the 100-foot buffer zone. Commissioner Larry Lown expressed concern over the amount of disturbance that would happen in the buffer zone to the Coastal Bank. The Agent explained that this is an upgrade and not new construction, and that Title 5 improvements are presumed to meet the performance standards set forth by the Wetlands Protection Act. Both the Mr. Farrell, and Commissioner Adams commented on how stable this particular section of coastal bank was. Discussion about how to protect the resource area during construction included a description of erosion control methods. The limit of work has been staked and it is close to the top of the coastal bank; a silt fence will be installed to prevent material from moving over the bank. The project will be completed using the smallest possible equipment and the two septic tanks closest to the top of bank will be plastic to minimize disturbance. The Agent asked about stockpiling of sand and the Commission decided to allow designation of an area within the 50' buffer for minimal stockpiling of materials as needed, as a condition, along with the notes on the plans, and pre-construction conditions.

**Motion: Commissioner Diane Messinger moved to approve the filing with conditions Second: Commissioner Mark Adams; Vote: 6-0; The motion passed.**

**Notice of Intent: 3 River View Road, Stephen Powell; SE# 75-1152:**

Mr. Powell and John O'Reilly were on the call to represent the project which involves vista pruning at the property. A view corridor that was created when the house was constructed in 1999 is now closing in on itself. The proposal includes the strategic removal of a few trees, as well as some limbing to reestablish the vista while planting, to add to the diversity of vegetative species in the area. A total of five pine trees will be removed, two from the 100-foot buffer zone to the coastal bank and two in the 50-foot buffer zone. The work will also include the flush cutting of three clusters of oak trees that are blocking the current vista. These flush cut oak trees would be maintained as shrubs after they resprout. There was discussion about the conditions, as selective pruning of the leaders, rather than topping was the allowable standard that would preserve the growth pattern of the trees. The Order of conditions would reflect on-going conditions that are found on notes 1-6 on the plan. Commissioners Lown and Messinger were concerned about the removal of the one oak tree positioned closest to the residence. There was discussion as to whether this tree is in or out of jurisdiction as the trunk is outside the 200-ft riverfront area, but the canopy within it. The property owner did have concerns that this tree could become a hazard to the residence. **Motion: Commissioner Larry Lown moved to approve the plan with the condition that the oak tree located closest**

to the residence and on the border of the jurisdictional area be pruned and not removed; **Second: Commissioner Diane Messinger; Vote: 2-4-0; the motion did not pass.**

**Motion: Commissioner Carol Girard-Irwin moved to approve the plan as proposed. Second: Commissioner Bob White; Vote: 4-2-0; The motion passed.**

**Field Change: 20 Toms Hill Path, SE# 75-1049**

The Agent explained the minor changes as proposed by the owner, to the Commission. The Commissioners discussed the magnitude of the changes and agreed that the changes were minimal

**Motion: Commissioner Diane Messinger moved to approve the field change; Second: Commissioner Mark Adams; Vote: 5-1; The motion passed.**

**Administrative Review Permit requests:**

**510 Shore Road, U: A;** two additional split rail fence sections:

**Motion: Commissioner Clint Kershaw moved to approve the administrative review permit; Second: Commission Chair Carol Girard Irwin; Vote: 6-0-0; The motion passed.**

**6 Castle Hill Lane;** remove two broken tree limbs:

**Motion: Commissioner Bob White moved to approve the administrative review; Second: Commissioner Larry Lown; Vote: 6-0-0; The motion passed.**

**Commissioner Larry Lown moved to adjourn the meeting.**

**Second: Commission Chair Carol Girard Irwin: 6-0-0; The motion passed.**

**The meeting was adjourned at 6:25 PM.**

Respectfully Submitted by Nina Richey